

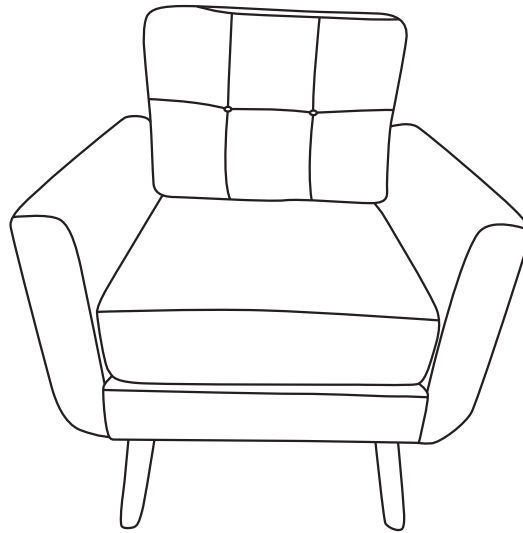

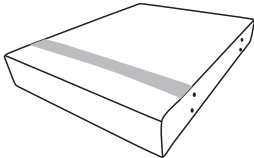



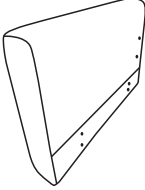
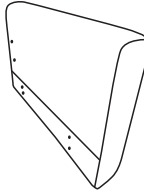
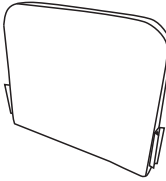
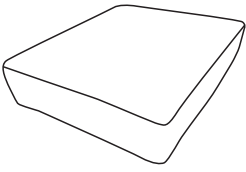
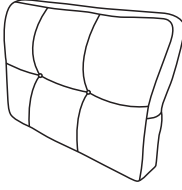

# ASSEMBLY INSTRUCTION

## CHAIR

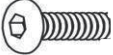

### PARTS LIST

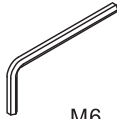
<b>A</b>  Tips:  Velcro 1PC	<b>B</b>  1PC	<b>C</b>  1PC	<b>D</b>  1PC	
<b>E</b>  1PC	<b>F</b>  1PC	<b>G</b>  4PCS	<b>H</b>  4PCS	
<b>J</b>  2PCS	<b>K</b>  M6x18mm 16PCS	<b>L</b>  M6x35mm 8PCS	<b>M</b>  ø6x18mm 4PCS	<b>N</b>  M6 1PC

## Installation Steps

### STEP 1

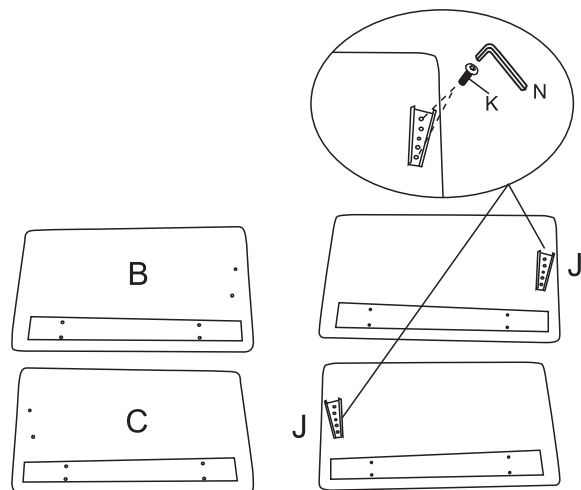

Attach part J to the screw holes of B and C using parts K and N.

### STEP 2

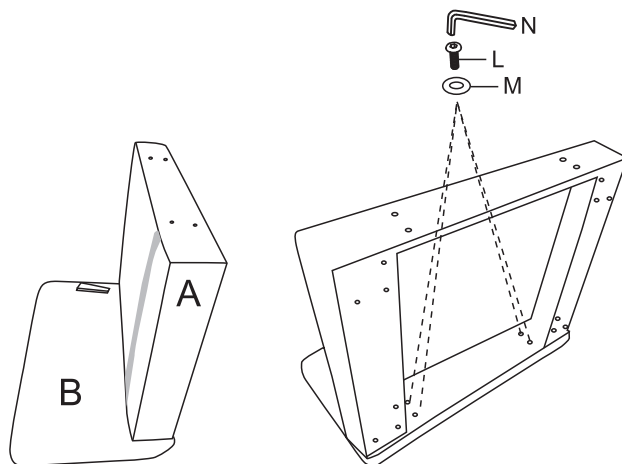

Align the screw holes in parts A and B. Insert part L into the holes of part M and the corresponding screw holes. Tighten the screws with part N.

### STEP 3

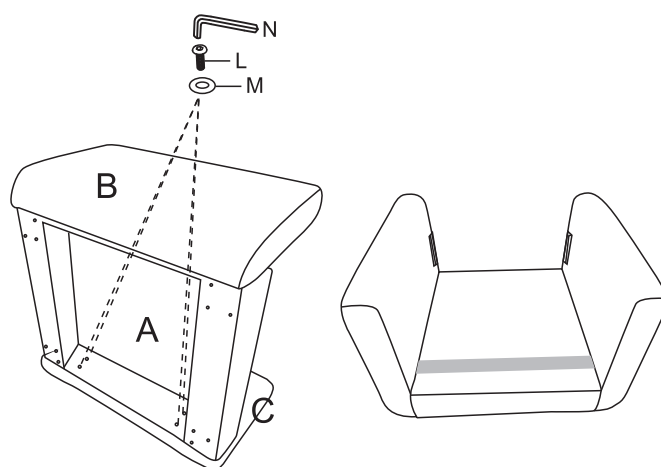

Align the screw holes in parts A and C. Insert part L into the holes of part M and the corresponding screw holes. Tighten the screws with part N.

## Installation Steps

### STEP 4

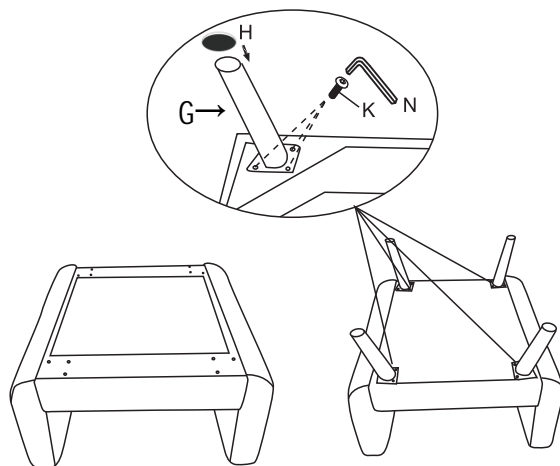

Attach part G to the bottom of the part A using parts K and N, paste part H to the bottom of the wooden leg

### STEP 5

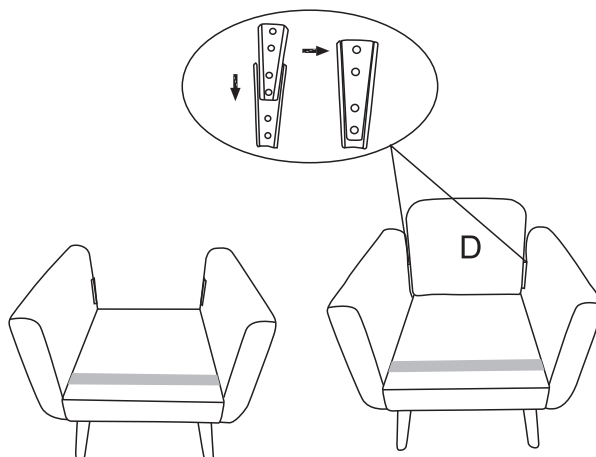

Insert part D, ensuring the parts align properly to make the connection.

### STEP 6

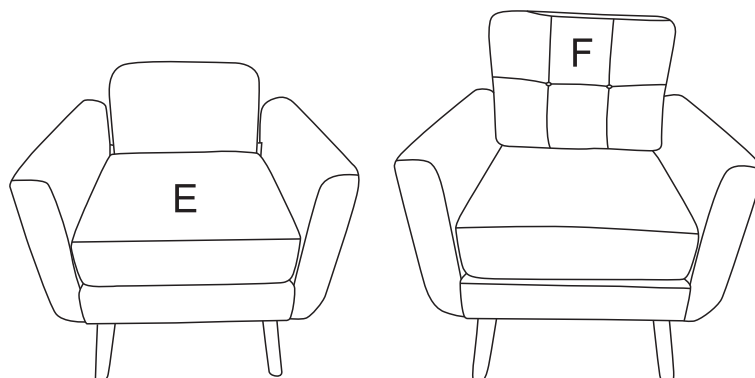

Place part E onto the seat and part F onto the backrest.  
(Note: After unpacking parts E and F, gently tap them and allow 48 hours for them to return to their pre-compressed state.)