

# INVAL

## Multi Purpose Cabinet *Gabinete multiusos*

REF.: GM 4340



SCAN THIS QR CODE  
FOR ASSEMBLY TIPS

ESCANEA EL CODIGO  
QR Y ENCUENTRA EN  
YOUTUBE VIDEOS CON  
TIPS DE ARMADO

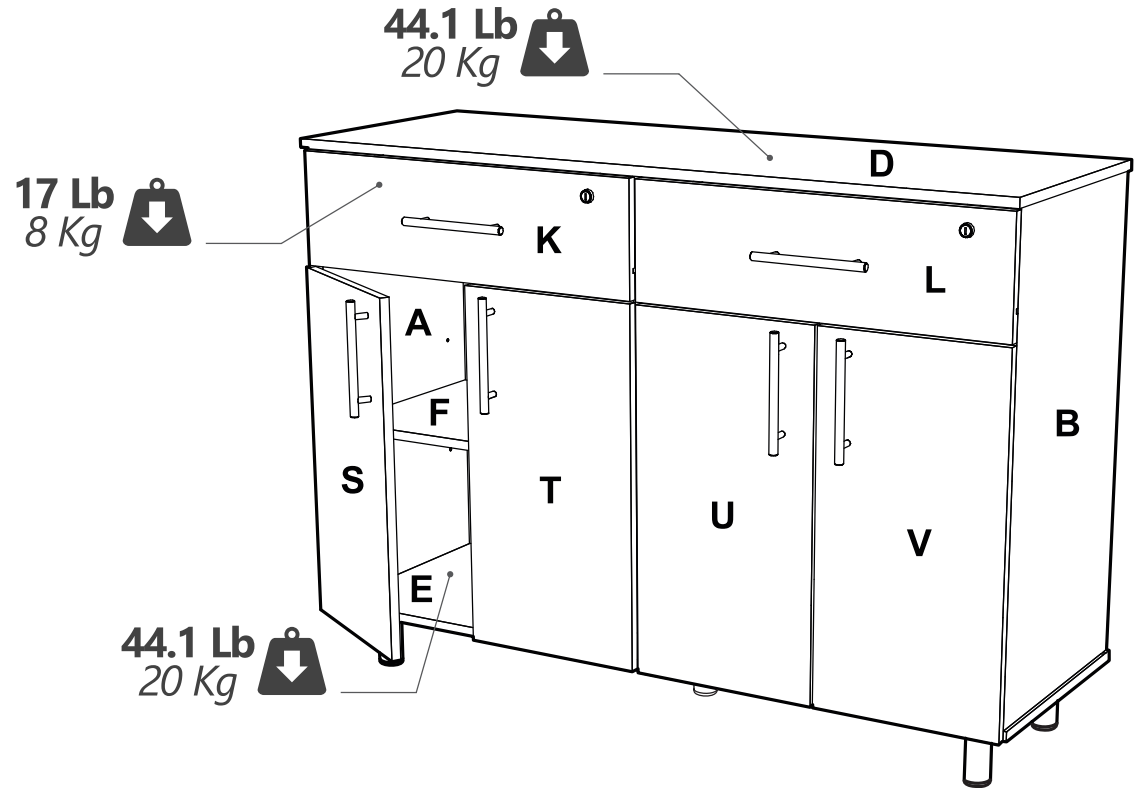

### ATTENTION ATENCIÓN

When calling or writing us, please provide the OP number, here highlighted, so we can offer the most efficient response.

Al llamar o escribirnos, por favor darnos el número de OP, aquí resaltado, con el fin de ofrecerle la respuesta mas eficiente.

OP: 000161

DATE/FECHA: 28/07/2023

FINISH/ACABADO: DARK GREY / AMBAR  
PLOMO / AMBAR

**PLEASE DON'T RETURN STORE  
CALL US OR EMAIL US FIRST**

**POR FAVOR NO REGRESE A LA TIENDA  
LLAMENOS O ENVIE UN EMAIL PRIMERO**

**WARNING - ADVERTENCIA**



TWO PEOPLE ARE REQUIRED  
TO PROPERLY ASSEMBLE AND MOVE THIS FURNITURE  
SE NECESITA DOS PERSONAS  
PARA ARMAR CORRECTAMENTE Y DESPLAZAR ESTE MUEBLE

**1-888-659-3512 EXT 178**

customerservice@invalamerica.com www.invalamerica.com



Certificado Nº sc 640-1

**¡Gracias por la compra de un producto INVAL!  
CERTIFICADO DE GARANTIA**

**Thank you for purchasing an INVAL product!  
CERTIFICATE OF GUARANTEE**

**¡Merci d'avoir acheté un produit INVAL!  
CERTIFICAT DE GARANTIE**

INVAL orgullosamente respalda los productos que fabricamos y por ello los garantizamos por un periodo de cinco (5) años después de la fecha de su compra. Para asistirle con mayor rapidez, por favor revise cuidadosamente todas las piezas y herrajes de este producto y así detectara faltantes, herrajes o piezas dañadas. Comuníquese de inmediato con nuestro Departamento de Servicio al Cliente o al Consumidor de acuerdo a nuestras líneas telefónicas y correo electrónico. Recibirá donde usted nos indique sin costo alguno las piezas o herrajes defectuosos o faltantes. Por favor tenga a mano el número del modelo o referencia, la Orden de Producción (OP) y la letra de la parte o pieza o el número del herraje que usted necesita. Esta información la encontrará en el manual de instrucciones. También necesitará tener a mano la factura o recibo de compra. Esta garantía será aplicable solo cuando se le de uso normal a este mueble por parte del consumidor. Estos productos no han sido diseñados ni fabricados para ser usados a la intemperie, en condiciones climáticas extremas o estar expuestos a la humedad o al agua. La palabra "defectos" se define en esta garantía específicamente a imperfecciones que impidan el uso de este producto al consumidor. Esta garantía no cubre: 1) Defectos que hayan sido causados por un armado defectuoso o incorrecto, 2) Defectos que ocurran después que usted haya comprado el producto y le haga cualquier modificación, roturas intencionales, accidentes, sobrecarga, uso indebido, negligencia o que sean expuestos a la intemperie, humedad, al agua o a cualquier sustancia química. 3) Daños en su apariencia. 4) Movimientos o traslados inadecuados de un lugar a otro que afecten la funcionalidad del producto. 5) Exposición del mueble a ambientes húmedos o de baja ventilación, alta temperatura, suciedad o ha insectos como el comején, termita, hormiga blanca o cualquier otro tipo de insecto que afecte el producto. 6) El tablero melamínico no se desprende siempre en cuando cumpla estrictamente las recomendaciones de uso y cuidado informadas en esta garantía. 7) El mueble comprado armado no tiene garantía. Esta garantía se limita al remplazo de piezas o herrajes que presenten defectos o faltantes, bajo las condiciones indicadas, la asistencia técnica podrá tener un costo adicional en caso de no aplicar la garantía. La labor de ensamble no está incluida.

INVAL proudly endorses the products we manufacture and therefore we guarantee them for a period of five (5) years after the date of purchase. To assist you more quickly, please carefully inspect all parts and hardware of this product for missing, hardware or damaged parts. Immediately contact our Customer or Consumer Service Department according to our phone lines and email. You will receive defective or missing parts or hardware where you indicate at no cost. Please have the model or reference number, the Production Order (OP) and the letter of the part or part or the number of the hardware you need. You will find this information in the instruction manual. You will also need to have your purchase invoice or receipt at hand. This guarantee will be applicable only when this furniture is used normally by the consumer. These products are not designed or manufactured to be used outdoors, in extreme weather conditions, or exposed to moisture or water. The word "defects" is defined in this warranty specifically to imperfections that prevent the use of this product by the consumer. This warranty does not cover: 1) Defects that have been caused by faulty or incorrect assembly, 2) Defects that occur after you have purchased the product and made any modification, intentional breakage, accident, overload, improper use, negligence or that are exposed to the weather, humidity, water or any chemical substance. 3) Damage to its appearance. 4) Inappropriate movements or transfers from one place to another that affect the functionality of the product. 5) Exposure of the furniture to humid environments or with low ventilation, high temperature, dirt or has insects such as termites, termites, white ant or any other type of insect that affects the product. 6) The melamine board does not come off as long as it strictly complies with the recommendations for use and care informed in this guarantee. 7) The furniture purchased assembled has no guarantee. This warranty is limited to the replacement of parts or hardware that are defective or missing, under the conditions indicated, technical assistance may have an additional cost if the warranty is not applied. Assembly labor is not included.

INVAL approuve fièrement les produits que nous fabriquons et par conséquent nous les garantissons pour une période de cinq (5) ans après la date d'achat. Pour vous aider plus rapidement, veuillez inspecter soigneusement toutes les pièces et le matériel de ce produit pour détecter les pièces manquantes, le matériel ou les pièces endommagées. Contactez immédiatement notre service clientèle ou notre service clientèle selon nos lignes téléphoniques et nos e-mails. Vous recevrez gratuitement des pièces ou du matériel défectueux ou manquants sur votre indication. Veuillez avoir le numéro de modèle ou de référence, l'ordre de fabrication (OP) et la lettre de la pièce ou de la pièce ou le numéro du matériel dont vous avez besoin. Vous trouverez ces informations dans le manuel d'instructions. Vous devez également avoir votre facture d'achat ou votre reçu à portée de main. Cette garantie ne sera applicable que lorsque ce meuble est utilisé normalement par le consommateur. Ces produits ne sont pas conçus ou fabriqués pour être utilisés à l'extérieur, dans des conditions météorologiques extrêmes ou exposés à l'humidité ou à l'eau. Le mot «défauts» est défini dans cette garantie spécifiquement aux imperfections qui empêchent l'utilisation de ce produit par le consommateur. Cette garantie ne couvre pas: 1) Les défauts qui ont été causés par un assemblage défectueux ou incorrect, 2) Les défauts survenant après avoir acheté le produit et effectué toute modification, casse intentionnelle, accident, surcharge, mauvaise utilisation, négligence ou que sont exposés aux intempéries, à l'humidité, à l'eau ou à toute substance chimique. 3) Dommages à son apparence. 4) Mouvements ou transferts inappropriés d'un endroit à un autre qui affectent la fonctionnalité du produit. 5) Exposition du meuble à des environnements humides ou à faible ventilation, des températures élevées, de la saleté ou des insectes tels que termites, termites, fourmis blanches ou tout autre type d'insecte qui affecte le produit. 6) Le panneau mélaminé ne se détache pas tant qu'il est strictement conforme aux recommandations d'utilisation et d'entretien informées dans cette garantie. 7) Les meubles achetés assemblés n'ont aucune garantie. Cette garantie est limitée au remplacement des pièces ou du matériel défectueux ou manquants, dans les conditions indiquées, l'assistance technique peut avoir un coût supplémentaire si la garantie n'est pas appliquée. Le travail de montage n'est pas inclus.

**Condiciones y limitaciones de la Garantía**

Warranty conditions and limitations  
Conditions de garantie et limitations

|  |         |
|--|---------|
| Estabilidad de la madera   | 5 AÑOS  |
| Wood stability   | 5 YEARS |
| Stabilité du bois  | 5 ANS   |
| Humedad, hongo o deterioro por condiciones ambientales extremas                        | 1 AÑO   |
| Moisture, fungus, or deterioration from extreme environmental conditions               | 1 YEAR  |
| Humidité, champignons ou détérioration due à des conditions environnementales extrêmes | 1 AN    |
| Recubrimiento de bordes en pvc   | 1 AÑO   |
| Edge coating in pvc  | 1 YEAR  |
| Hrevêtement de chant en pvc  | 1 AN    |
| Herrajes móviles, de unión y de ensamble (Bisagras, rieles, cerraduras, etc.)          | 1 AÑO   |
| Movable, joining and assembly hardware (Hinges, rails, locks, etc.)                    | 1 YEAR  |
| Quincaillerie mobile, d'assemblage et d'assemblage (charnières, rails, serrures, etc.) | 1 AN    |
| Sillas fijas y giratorias  | 1 AÑO   |
| Fixed and rotating chairs  | 1 YEAR  |
| Chaises fixes et rotatives   | 1 AN    |

**Contacto**



Contact  
Contact

Para hacer efectiva su garantía, el consumidor deberá comunicarse con nuestro Servicio al Cliente a las siguientes líneas telefónicas, por la página Web o por correo electrónico, teniendo a la mano este Certificado de Garantía y la Factura de Compra del Producto, donde podrá indicar sus quejas, inquietudes, reclamos o sugerencias, que nos permita mejorar en nuestros productos y servicios.

To make their guarantee effective, the consumer must contact our Customer Service at the following telephone lines, through the website or by email, having this Guarantee Certificate and the Product Purchase Invoice at hand, where they can indicate their complaints, concerns, claims or suggestions that allow us to improve our products and services.

Pour rendre sa garantie effective, le consommateur doit contacter notre service clientèle aux lignes téléphoniques suivantes, via le site Web ou par courrier électronique, en ayant à portée de main ce certificat de garantie et la facture d'achat de produit, où il peut indiquer son plaintes, préoccupations, réclamations ou suggestions qui nous permettent d'améliorer nos produits et services.

| Pais/Country/Pays                                | Teléfono/Telephone/Téléphones   | Contacto/Contact/Contact         |
|--|---|----------------------------------|
| Colombia/Colombia/Columbie                       | 01-8000-933-444   | servicliente@inval.com.co        |
| US - Canadá/EE.UU.-Canada/<br>Etats-Unis- Canada | 1-888-659-3512 x 178<br>Fax 1-888-901-0088  | customerservice@invalamerica.com |
| México/Mexico/Mexique                            | 52 (55) 41 708 748  | servicliente@inval.com.co        |
| Otros Países/Other countries<br>/Autres pays     |  (57) 317 428 2761 | servicliente@inval.com.co        |

| MANUAL DEL BUEN USO DEL PRODUCTO  | PRODUCT GOOD USE MANUAL   | MANUEL D'UTILISATION DU PRODUIT  |
|---|---|--|
| <p>Damos gracias por haber seleccionado nuestros productos y esperamos vernos favorecidos con sus futuras compras. Antes de empezar a armar este mueble, lea este instructivo, revise cuidadosamente las piezas y herrajes y realice el inventario para identificar que todo esté completo y en buen estado.</p> <p> En caso de que le haga falta alguna pieza o herraje, no devuelva el producto a la tienda, por favor llame a la línea de servicio al cliente o al consumidor de INVAL o escríbanos vía página web o por correo electrónico. Acuda a la línea de Servicio al Cliente INVAL cuando lo crea necesario para aclarar dudas sobre el mueble.</p> | <p>In the event that you are missing any parts or hardware, do not return the product to the store, please call INVAL's customer or consumer service line or write to us via the website or by email. Go to the INVAL Customer Service line when you think it is necessary to clarify doubts about the furniture.</p> <p> In the event that you are missing any parts or hardware, do not return the product to the store, please call INVAL's customer or consumer service line or write to us via the website or by email. Go to the INVAL Customer Service line when you think it is necessary to clarify doubts about the furniture.</p> | <p>Nous sommes reconnaissants d'avoir sélectionné nos produits et espérons être favorisés lors de vos futurs achats. Avant de commencer à assembler ce meuble, lisez ce manuel d'instructions, examinez attentivement les pièces et la quincaillerie et faites l'inventaire pour vous assurer que tout est complet et en bon état.</p> <p> Dans le cas où il vous manque des pièces ou du matériel, ne renvoyez pas le produit au magasin, veuillez appeler la ligne de service client ou consommateur d'INVAL ou nous écrire via le site Web ou par courrier électronique. Rendez-vous sur la ligne Service Client INVAL lorsque vous pensez qu'il est nécessaire de clarifier les doutes sur le mobilier.</p> |



Lea y siga detenidamente el orden consecutivo de las instrucciones de armado.  
 Read and carefully follow the sequential order of the assembly instructions.  
 Lisez et suivez attentivement l'ordre séquentiel des instructions d'assemblage.



Arme el mueble en una superficie limpia, si desea puede usar el empaque como protector para evitar que el mueble se raye con el piso.  
 Assemble the furniture on a clean surface, if you wish you can use the packaging as a protector to prevent the furniture from being scratched by the floor.  
 Assemblez le meuble sur une surface propre, si vous le souhaitez, vous pouvez utiliser l'emballage comme protecteur pour éviter que le meuble ne soit rayé par le sol.



Ensamble y ubique el mueble sobre una superficie plana y nivelada; para asegurar su correcto funcionamiento y evitar su deterioro.  
 Assemble and place the furniture on a flat and level surface; to ensure its proper functioning and prevent deterioration.  
 Assemblez et placez les meubles sur une surface plane et de niveau; pour garantir son bon fonctionnement et éviter sa détérioration.



Limpie el mueble periódicamente con su producto limpiador favorito, evite usar sustancias químicas, abrasivas o agua en exceso. En caso de que el mueble se moje, séquelo inmediatamente con un trapo seco absorbente.  
 Clean the furniture periodically with your favorite cleaning product, avoid using chemicals, abrasives or excess water. In case the furniture gets wet, wipe it dry immediately with a dry absorbent cloth.  
 Nettoyez régulièrement les meubles avec votre produit de nettoyage préféré, évitez d'utiliser des produits chimiques, des abrasifs ou un excès d'eau. Si le meuble est mouillé, essuyez-le immédiatement avec un chiffon absorbant sec.



Proteja el mueble del agua y de la humedad.  
 Protect the furniture from water and humidity.  
 Protégez les meubles de l'eau et de l'humidité.



Se requiere de dos personas para armar y mover este mueble.  
 It takes two people to assemble and move this furniture.  
 Il faut deux personnes pour assembler et déplacer ce meuble.



Durante el armado no golpee ni martille el producto, hágalo solo donde se indica.  
 During assembly do not strike or hammer the product, do so only where indicated.  
 Lors de l'assemblage, ne pas frapper ni marteler le produit, ne le faites que là où cela est indiqué.



No pinte el mueble.  
 Do not paint the furniture.  
 Ne peignez pas les meubles.



Evite que los menores se suban al mueble.  
 Prevent minors from climbing onto the furniture.  
 Empêchez les mineurs de grimper sur les meubles.



Evite la exposición del mueble a ambientes húmedos o de baja ventilación, alta temperatura, suciedad o ha insectos como la termita, hormiga blanca o cualquier otro tipo de insecto que afecte el producto.  
 Avoid exposing the furniture to humid or low ventilation environments, high temperatures, dirt or insects such as termites, white ant or any other type of insect that affects the product.  
 Évitez d'exposer les meubles à des environnements humides ou à faible ventilation, à des températures élevées, à de la saleté ou à des insectes tels que termites, fourmis blanches ou tout autre type d'insecte qui affecte le produit.



No use el mueble al aire libre. Evite colocar objetos calientes sobre las superficies del mueble.  
 Do not use the furniture outdoors. Avoid placing hot objects on furniture surfaces.  
 N'utilisez pas les meubles à l'extérieur. Évitez de placer des objets chauds sur les surfaces des meubles.

**Required Tools**

Herramientas Requeridas

Outils Nécessaires

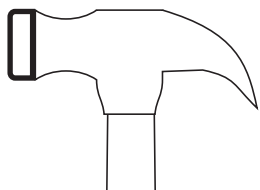

**Hammer**  
Martillo  
Marteau

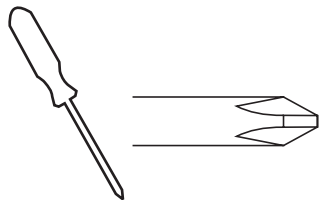

**Philips Screwdriver**  
Atornillador Estrella  
Tournevis Cruciforme

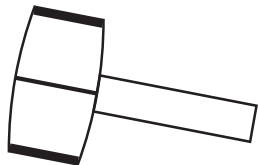

**Rubber Hammer**  
Martillo De goma  
Marteau en Caoutchouc

**Cam Lock**

Tuerca

**Largest hole**  
Perforación amplia  
Plus grand trou

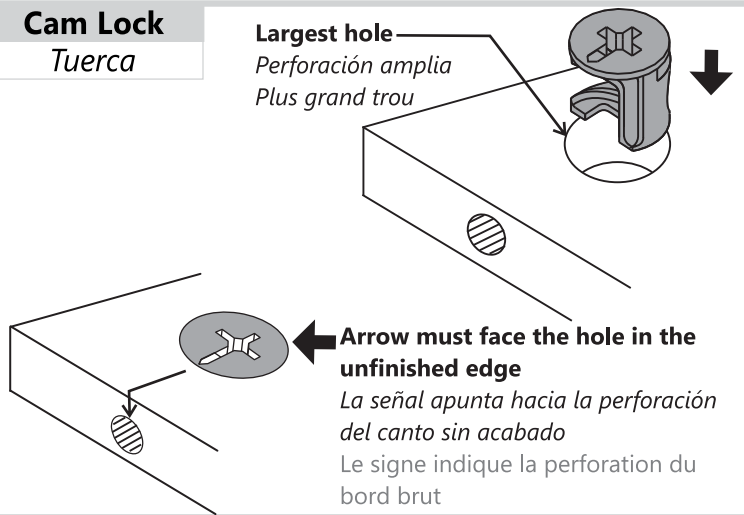

**Arrow must face the hole in the unfinished edge**  
La señal apunta hacia la perforación del canto sin acabado  
Le signe indique la perforation du bord brut

**Cam Stud**

Perno

**Do NOT insert the cam studs in the edge holes**  
NO INSERTE pernos en las perforaciones de los cantos  
NE PAS INSÉRER de boulons dans les bords

**Insert only in face hole**  
Inserte unicamente en las perforaciones indicadas  
Insérer uniquement dans les trous indiqués

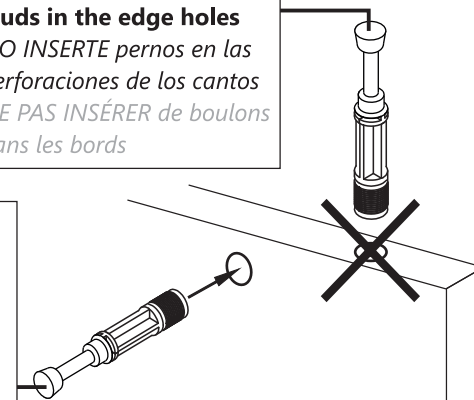

**Wooden Dowels**

Tarugo de madera

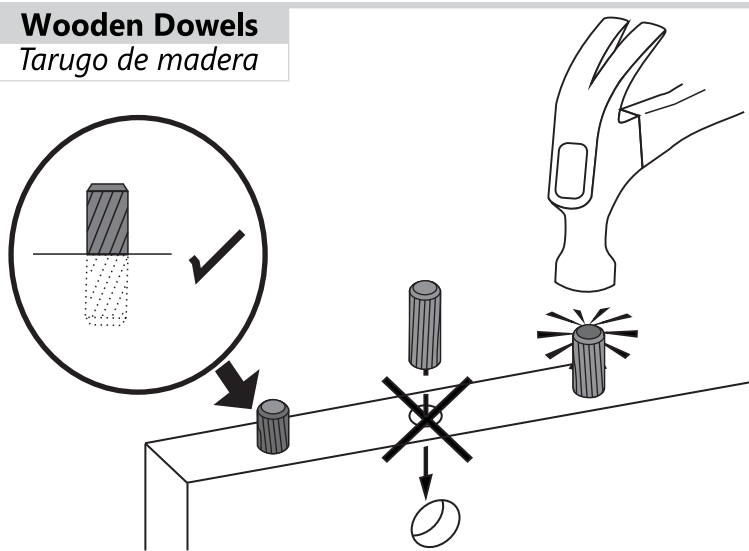

**Locking Twist**

Giro de bloqueo

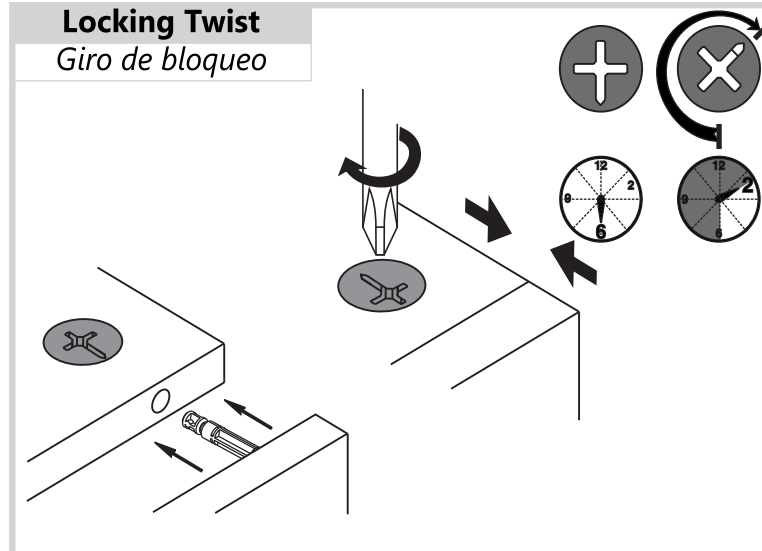

(ES) El ensamble adecuado de este herraje garantiza su durabilidad (EN) Adequate assembly of this fitting guarantee item sturdiness (FR) Un bon assemblage de ce matériel garantit sa durabilité

(EN) **IMPORTANT** Illustrations depicted in this manual are representative of the assembly process. For this reason, physical fittings can change and not be identical of the ones shown in the illustrations. INVAL S.A. keeps the rights of making changes with no previous advice. (ES) **IMPORTANTE** Las Imágenes e ilustraciones de los herrajes en este manual son representativos para guiar al usuario durante el proceso de armado, por lo anterior el herraje físico no debe ser necesariamente igual a la ilustración. INVAL S.A. se reserva el derecho de hacer cambios sin previo aviso. (FR) **IMPORTANT** Les images et illustrations du matériel dans ce manuel sont représentatives pour guider l'utilisateur pendant le processus d'assemblage, par conséquent le matériel physique ne doit pas nécessairement être le même que l'illustration. INVAL S.A. se réserve le droit d'apporter des modifications sans préavis.

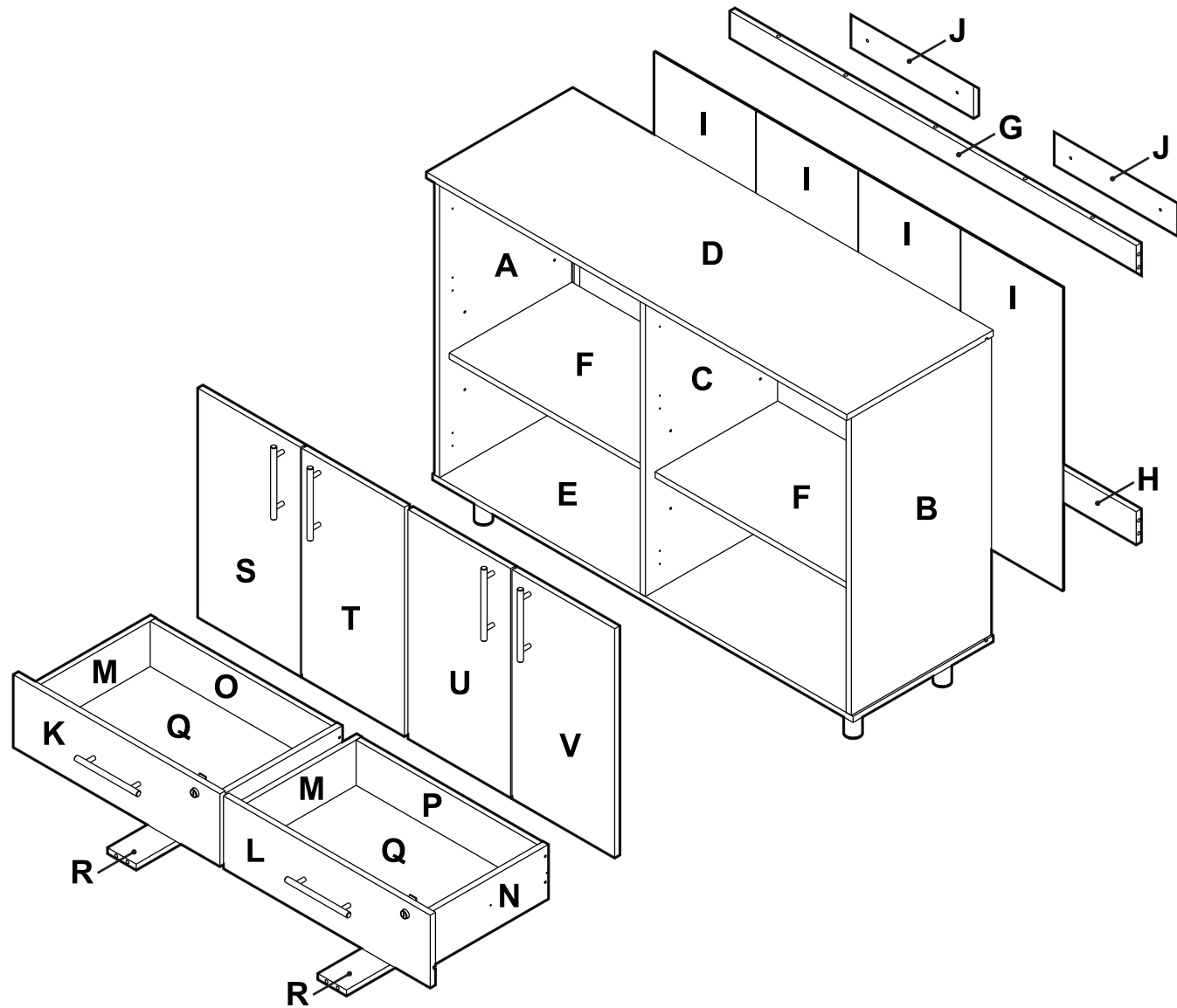

| Part<br>Pieza | Quantity<br>Cantidad |
|---------------|----------------------|
| A             | 1                    |
| B             | 1                    |
| C             | 1                    |
| D             | 1                    |
| E             | 1                    |
| F             | 2                    |
| G             | 1                    |
| H             | 1                    |
| I             | 4                    |
| J             | 2                    |
| K             | 1                    |
| L             | 1                    |
| M             | 2                    |
| N             | 2                    |
| O             | 1                    |
| P             | 1                    |
| Q             | 2                    |
| R             | 2                    |
| S             | 1                    |
| T             | 1                    |
| U             | 1                    |
| V             | 1                    |

**TOTAL**  
31

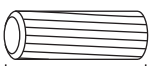
|   |         |
|---|---------|
|  | X<br>24 |
| 1 WOODEN DOWELS<br>TARUGOS DE MADERA  |         |

1-3/16"  
30 mm

|   |         |
|---|---------|
|  | X<br>20 |
| 2 CAM STUDS<br>PERNOS   |         |

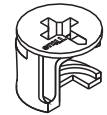
|  |         |
|--|---------|
|  | X<br>20 |
| 3 CAM LOCKS<br>TUERCAS   |         |

|   |         |
|---|---------|
|  | X<br>20 |
| 4 BLACK SCREW<br>TORNILLO NEGRO   |         |

2"  
50.8 mm

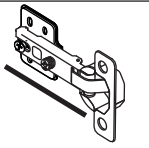
|   |        |
|---|--------|
|  | X<br>4 |
| 5a DOOR HINGE<br>BISAGRA PUERTA   |        |

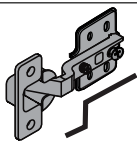
|   |        |
|---|--------|
|  | X<br>4 |
| 5b DOOR HINGE<br>BISAGRA PUERTA   |        |

|   |         |
|---|---------|
|  | X<br>32 |
| 6 HINGE SCREWS<br>TORNILLO BISAGRA  |         |

1/4"  
6 mm

1/2"  
12.5 mm

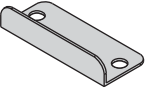
|  |        |
|--|--------|
|  | X<br>2 |
| 7 CATCH<br>PLATINA   |        |

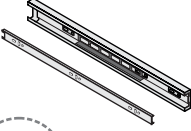
|   |        |
|---|--------|
|  | X<br>4 |
| 8 SLIDES<br>CORREDERAS  |        |

|   |         |
|---|---------|
|  | X<br>28 |
| 9 SLIDE SCREWS<br>TORNILLO CORREDERA  |         |

1/4"  
6 mm

1/2"  
12.5 mm

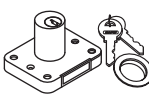
|   |        |
|---|--------|
|  | X<br>2 |
| 10 LOCK<br>CERRADURA  |        |

|   |        |
|---|--------|
|  | X<br>8 |
| 11 LOCK SCREW<br>TORNILLO CERRADURA   |        |

3/4"  
19 mm

|  |        |
|--|--------|
|  | X<br>5 |
| 12 GLINDERS<br>DESLIZADORES  |        |

|   |        |
|---|--------|
|  | X<br>6 |
| 13 HANDLES & SCREWS<br>MANIJA Y TORNILLOS   |        |

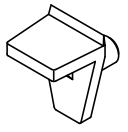
|   |        |
|---|--------|
|  | X<br>8 |
| 14 PANEL SUPPORT<br>SOPORTE ENTREPAÑO   |        |

|   |        |
|---|--------|
|  | X<br>4 |
| 15 CAM CAPS<br>TAPA TUERCAS   |        |

|   |        |
|---|--------|
|  | X<br>4 |
| 16 WALL SCREW<br>TORNILLO A PARED   |        |

10mm

2 1/2"  
63.5 mm

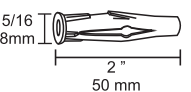
|  |        |
|--|--------|
|  | X<br>4 |
| 17 WALL ANCHOR<br>CHAZO ANCLA  |        |

5/16"  
8mm

2"  
50 mm

|   |        |
|---|--------|
|  | X<br>5 |
| 18 NAILS<br>PUNTILLAS   |        |

|   |        |
|---|--------|
|  | X<br>5 |
| 19 NAIL WASHERS<br>ARANDELA ESTRELLA  |        |

|  |         |
|--|---------|
|  | X<br>20 |
| 20 GLINDER SCREW<br>TORNILLO DESLIZADOR  |         |

5/16"  
8 mm

1/2"  
12.5 mm

**SEPARATE / SEPARAR**

**FULL EXTENSION SLIDE / CORREDERA EXTENSIÓN TOTAL**

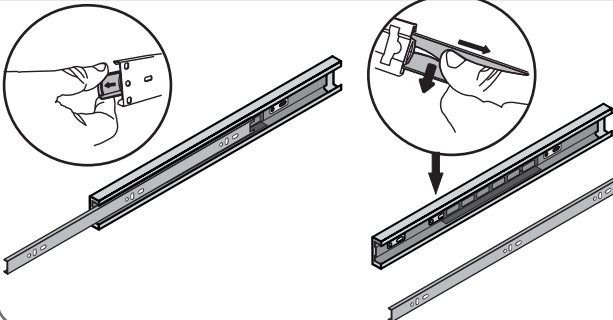

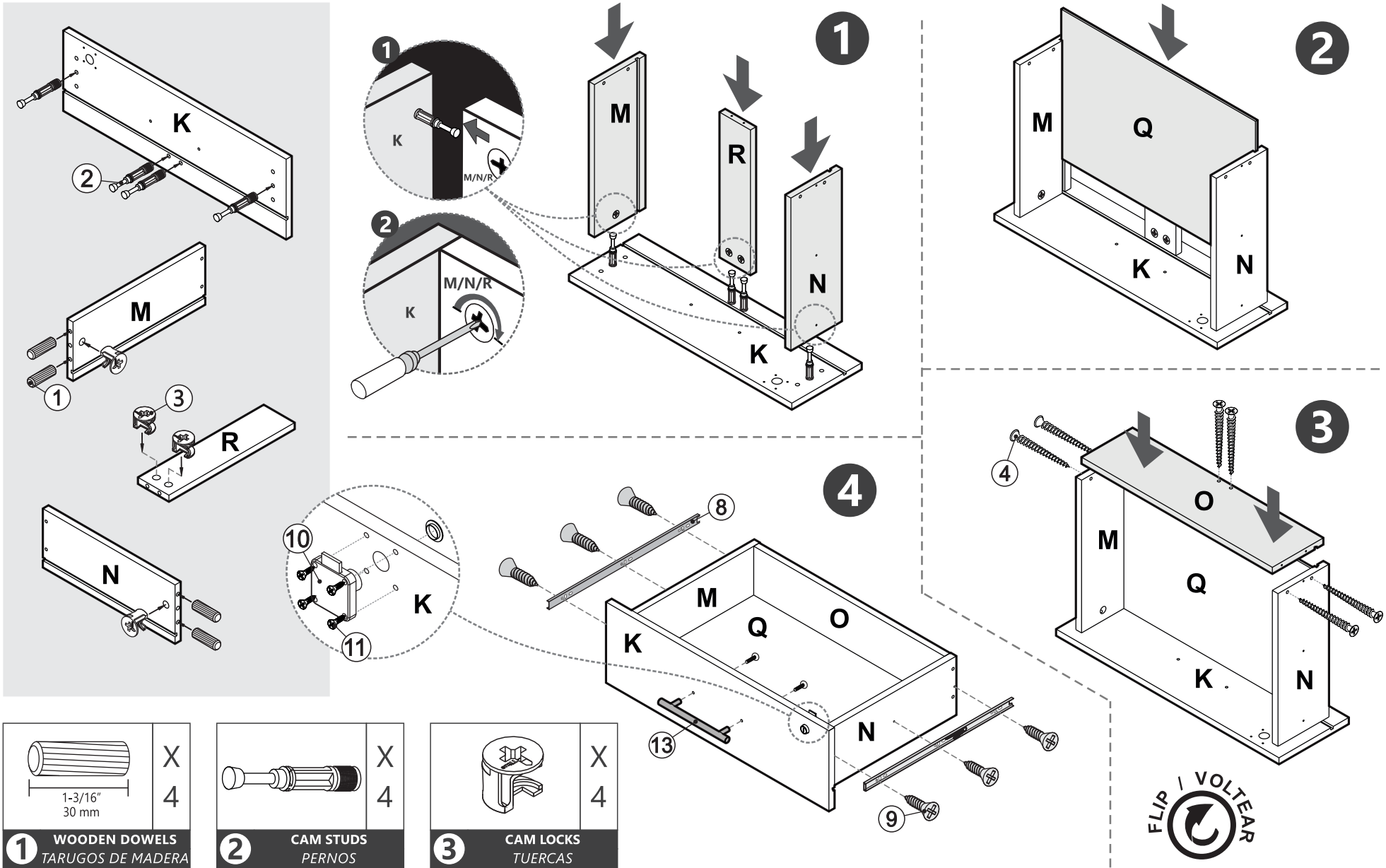

|   |        |
|---|--------|
|  | X<br>4 |
| 1-3/16"<br>30 mm  |        |
| <b>1</b> WOODEN DOWELS<br>TARUGOS DE MADERA   |        |

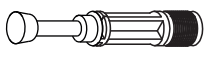
|   |        |
|---|--------|
|  | X<br>4 |
| <b>2</b> CAM STUDS<br>PERNOS  |        |

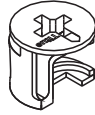
|   |        |
|---|--------|
|  | X<br>4 |
| <b>3</b> CAM LOCKS<br>TUERCAS   |        |

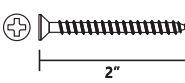
|   |        |
|---|--------|
|  | X<br>6 |
| 2"<br>50.8 mm   |        |
| <b>4</b> BLACK SCREW<br>TORNILLO NEGRO  |        |

|   |        |
|---|--------|
|  | X<br>2 |
| <b>8</b> SLIDES<br>CORREDERAS   |        |

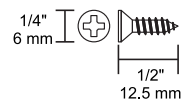
|   |        |
|---|--------|
|  | X<br>6 |
| 1/4"<br>6 mm   1/2"<br>12.5 mm  |        |
| <b>9</b> SLIDE SCREWS<br>TORNILLO CORREDERA   |        |

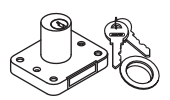
|   |        |
|---|--------|
|  | X<br>1 |
| <b>10</b> LOCK<br>CERRADURA   |        |

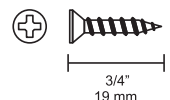
|   |        |
|---|--------|
|  | X<br>4 |
| 3/4"<br>19 mm   |        |
| <b>11</b> LOCK SCREW<br>TORNILLO CERRADURA  |        |

|   |        |
|---|--------|
|  | X<br>1 |
| <b>13</b> HANDLES & SCREWS<br>MANIJA Y TORNILLOS                                      |        |



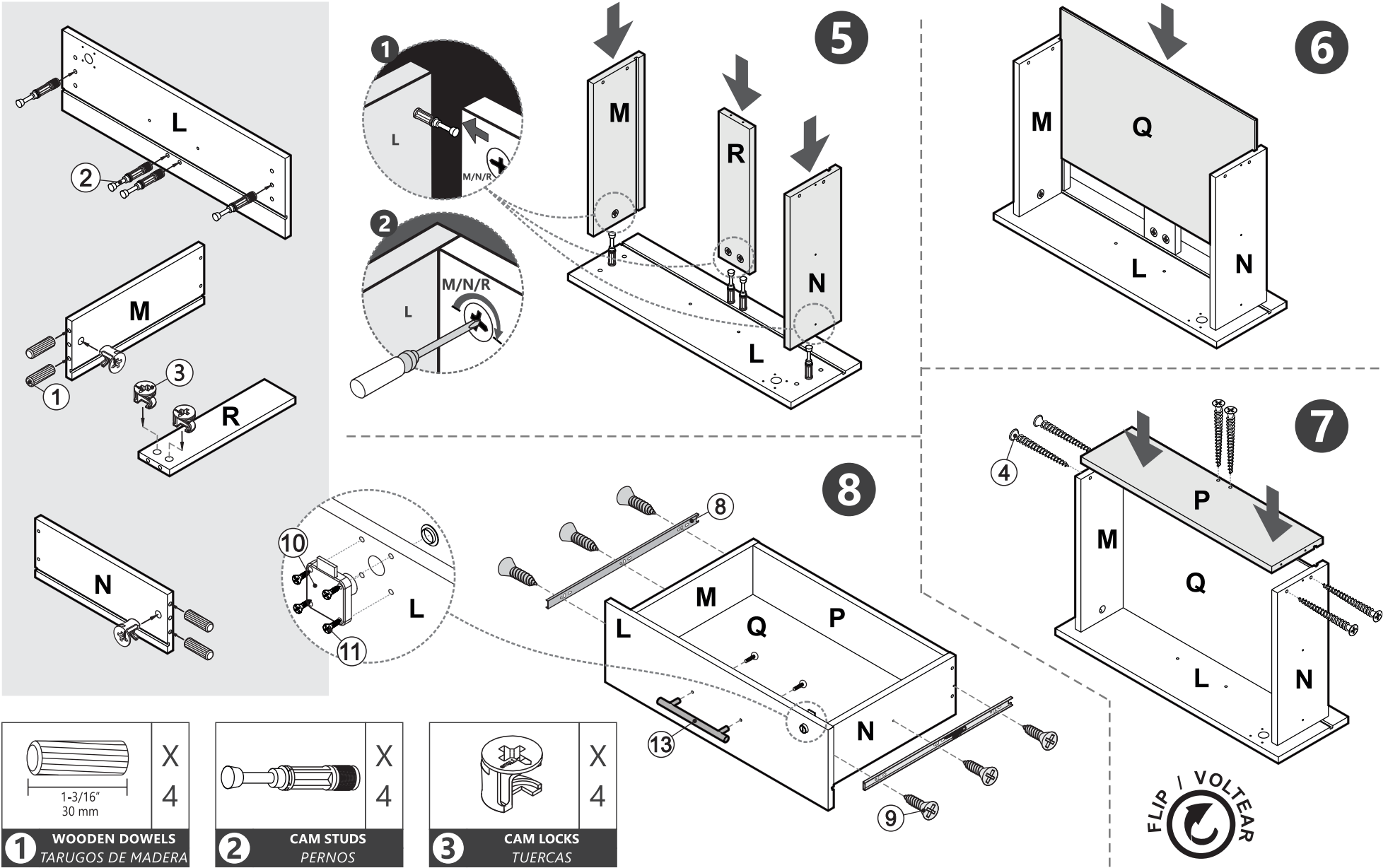

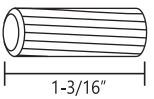
|  |   |
|--|---|
|  | X |
| 1-3/16"<br>30 mm   | 4 |
| <b>1</b> WOODEN DOWELS<br>TARUGOS DE MADERA  |   |

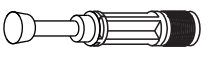
|   |   |
|---|---|
|  | X |
|   | 4 |
| <b>2</b> CAM STUDS<br>PERNOS  |   |

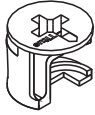
|   |   |
|---|---|
|  | X |
|   | 4 |
| <b>3</b> CAM LOCKS<br>TUERCAS   |   |

|  |   |
|--|---|
|  | X |
| 2"<br>50.8 mm  | 6 |
| <b>4</b> BLACK SCREW<br>TORNILLO NEGRO   |   |

|   |   |
|---|---|
|  | X |
|   | 2 |
| <b>8</b> SLIDES<br>CORREDERAS   |   |

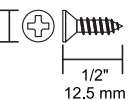
|   |   |
|---|---|
|  | X |
| 1/4"<br>6 mm  | 6 |
| 1/2"<br>12.5 mm   |   |
| <b>9</b> SLIDE SCREWS<br>TORNILLO CORREDERA   |   |

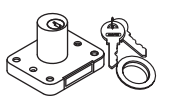
|  |   |
|--|---|
|  | X |
|  | 1 |
| <b>10</b> LOCK<br>CERRADURA  |   |

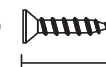
|   |   |
|---|---|
|  | X |
| 3/4"<br>19 mm   | 4 |
| <b>11</b> LOCK SCREW<br>TORNILLO CERRADURA  |   |

|   |   |
|---|---|
|  | X |
|   | 1 |
| <b>13</b> HANDLES & SCREWS<br>MANIJA Y TORNILLOS                                      |   |



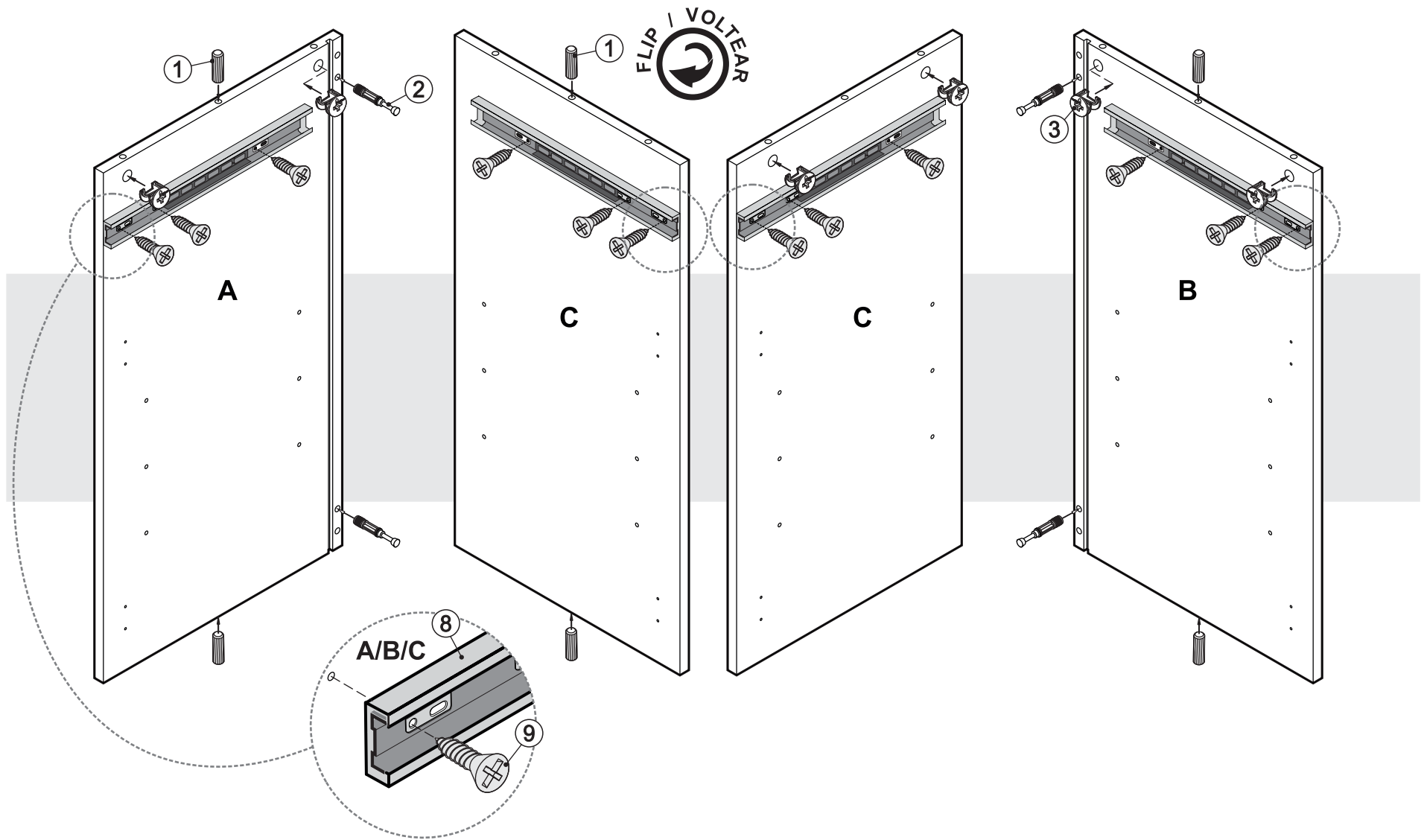

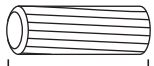
|   |        |
|---|--------|
|  | X<br>6 |
| 1-3/16"<br>30 mm  |        |
| <b>1</b> WOODEN DOWELS<br>TARUGOS DE MADERA   |        |

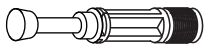
|   |        |
|---|--------|
|  | X<br>4 |
| <b>2</b> CAM STUDS<br>PERNOS  |        |

|   |        |
|---|--------|
|  | X<br>6 |
| <b>3</b> CAM LOCKS<br>TUERCAS   |        |

|   |        |
|---|--------|
|  | X<br>4 |
| <b>8</b> SLIDES<br>CORREDERAS   |        |

|   |                 |
|---|-----------------|
|  | X<br>12         |
| 1/4"<br>6 mm  | 1/2"<br>12.5 mm |
| <b>9</b> SLIDE SCREWS<br>TORNILLO CORREDERA   |                 |

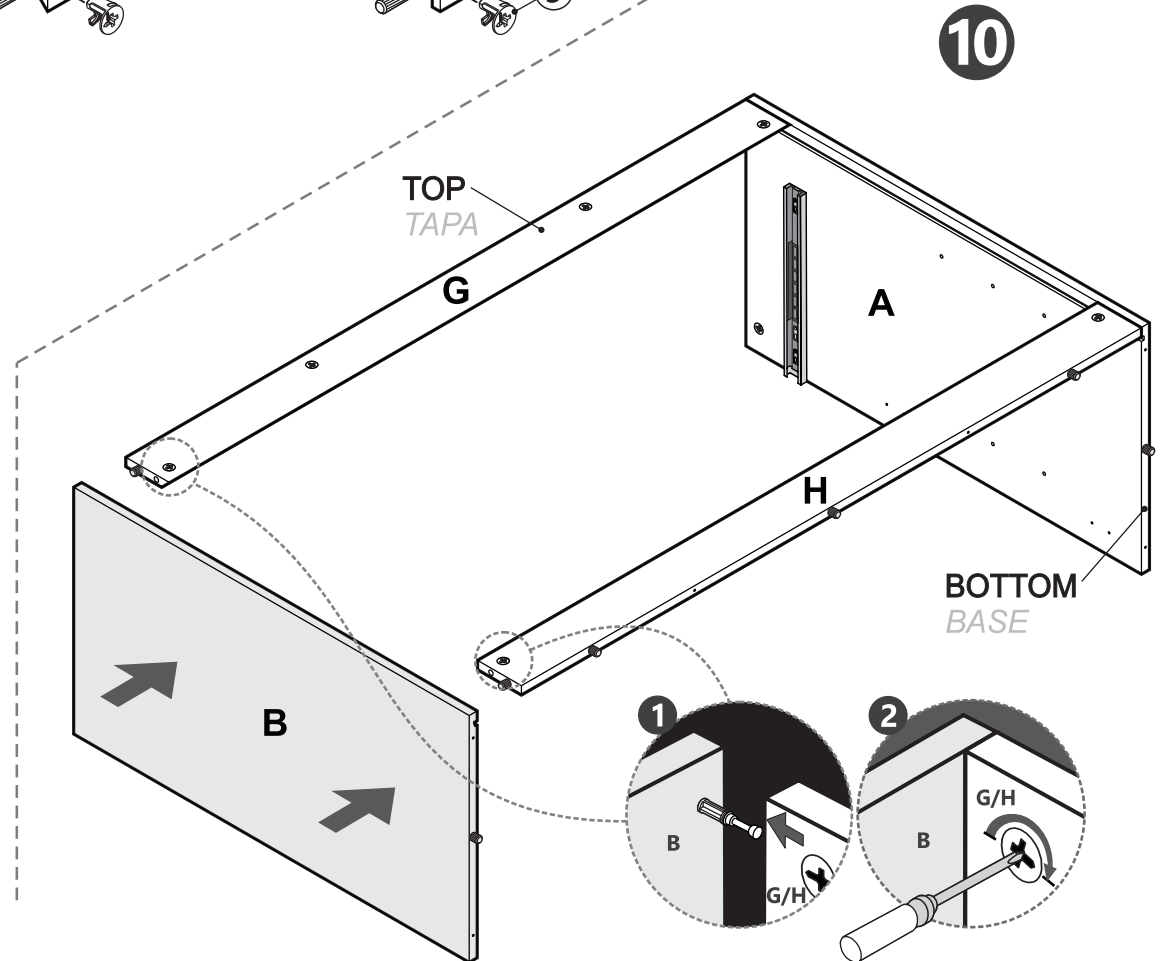
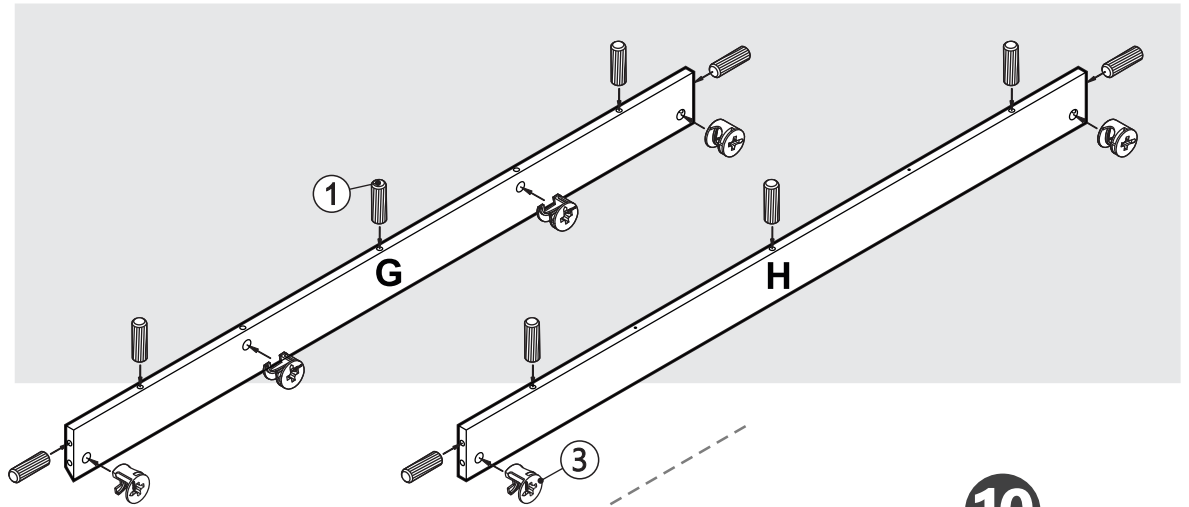
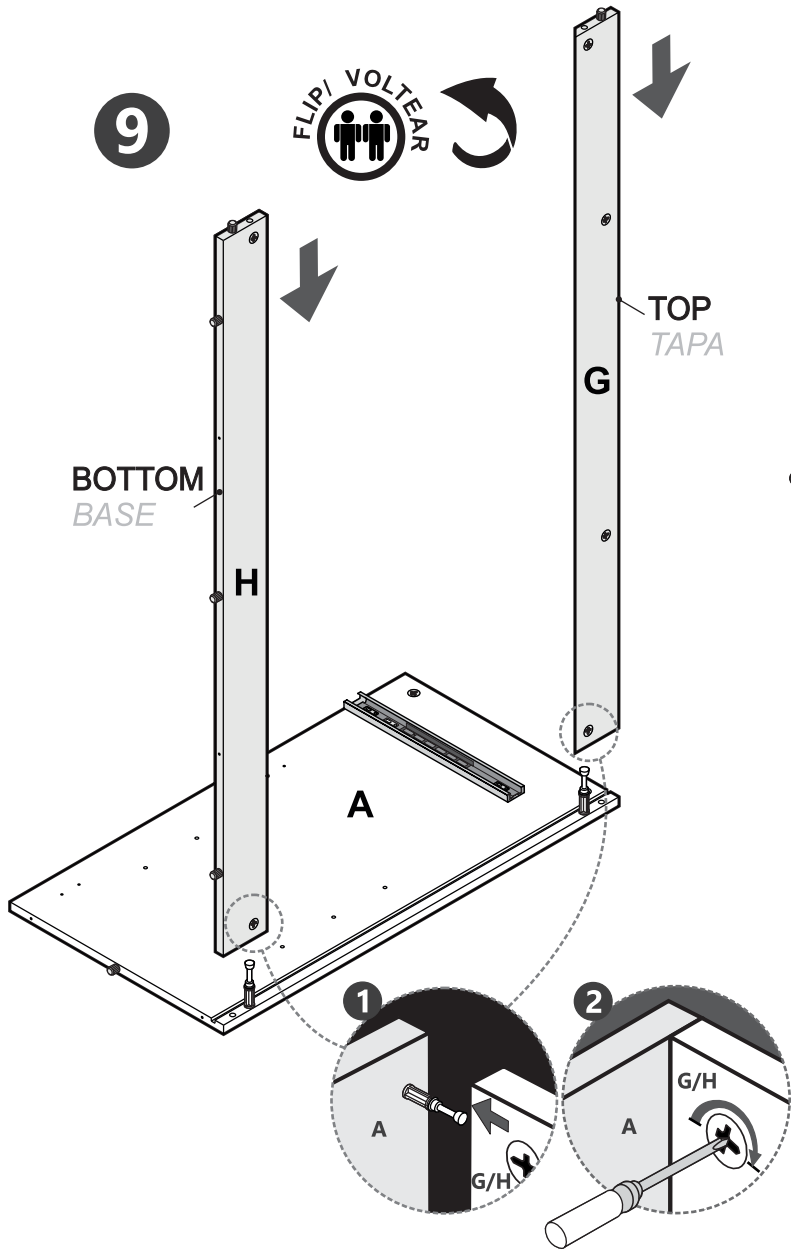

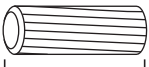
|  |    |
|--|----|
|  | X  |
| 1-3/16"<br>30 mm   | 10 |
| <b>1</b> WOODEN DOWELS<br>TARUGOS DE MADERA  |    |

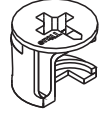
|   |   |
|---|---|
|  | X |
|   | 6 |
| <b>3</b> CAM LOCKS<br>TUERCAS   |   |

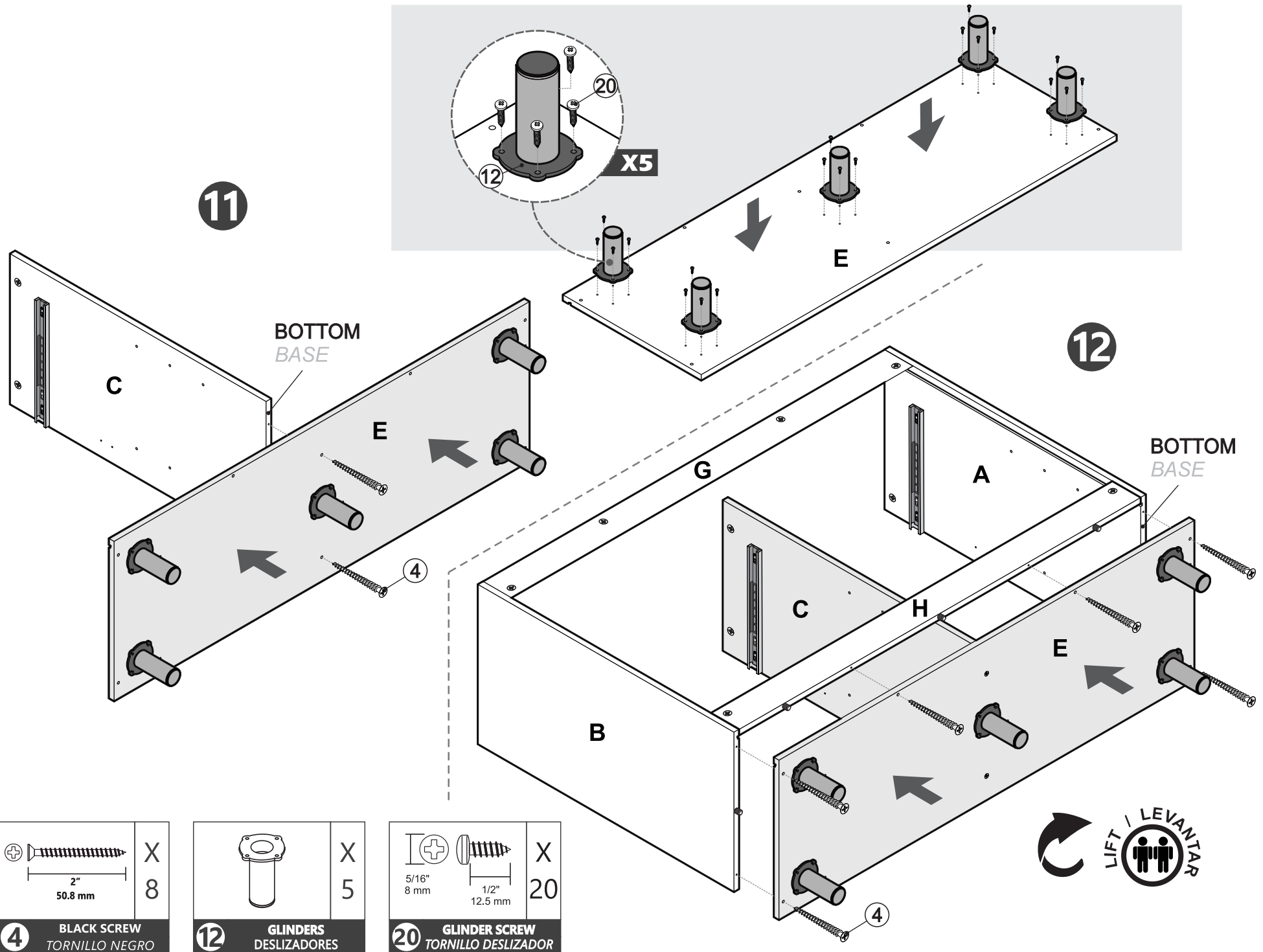

|   |                                      |
|---|--------------------------------------|
|  | X                                    |
| 2"  | 8                                    |
| 50.8 mm   |                                      |
| <b>4</b>  | <b>BLACK SCREW</b><br>TORNILLO NEGRO |

|   |                                 |
|---|---------------------------------|
|  | X                               |
|   | 5                               |
| <b>12</b>   | <b>GLIDERS</b><br>DESILIZADORES |

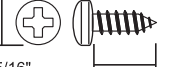
|   |   |
|---|---|
|  | X   |
| 5/16"   | 20  |
| 8 mm  |   |
| 1/2"  |   |
| 12.5 mm   |   |
| <b>20</b>   | <b>GLINDER SCREW</b><br>TORNILLO DESLIZADOR |



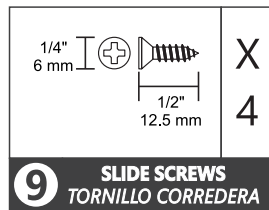
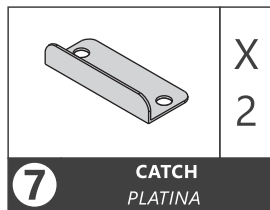
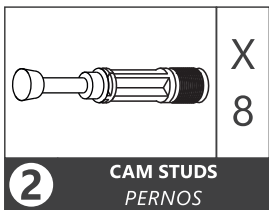
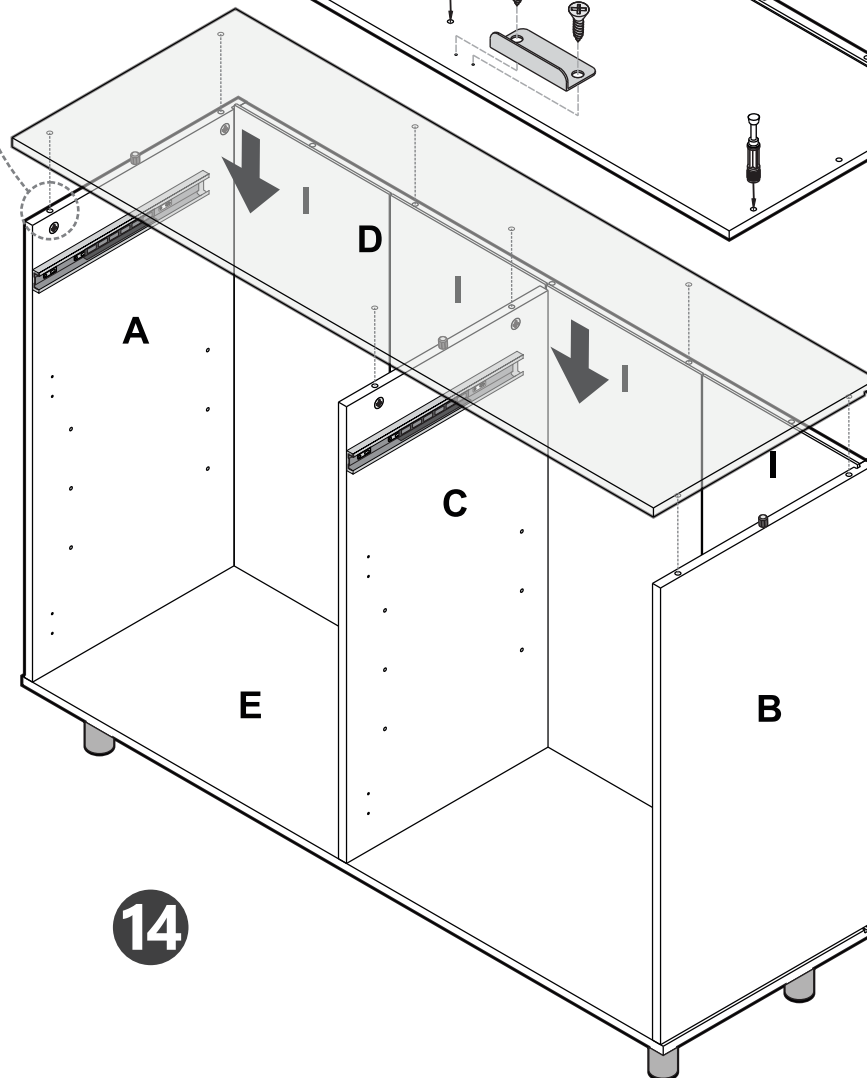
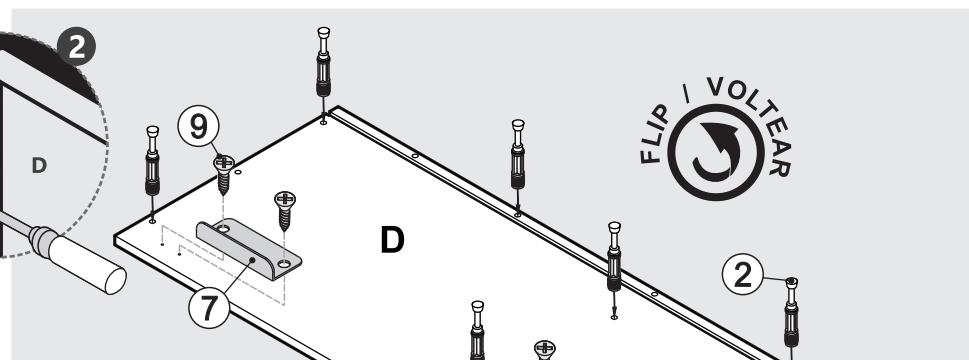
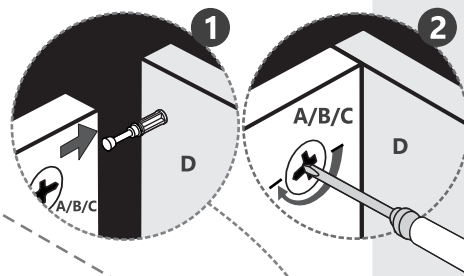
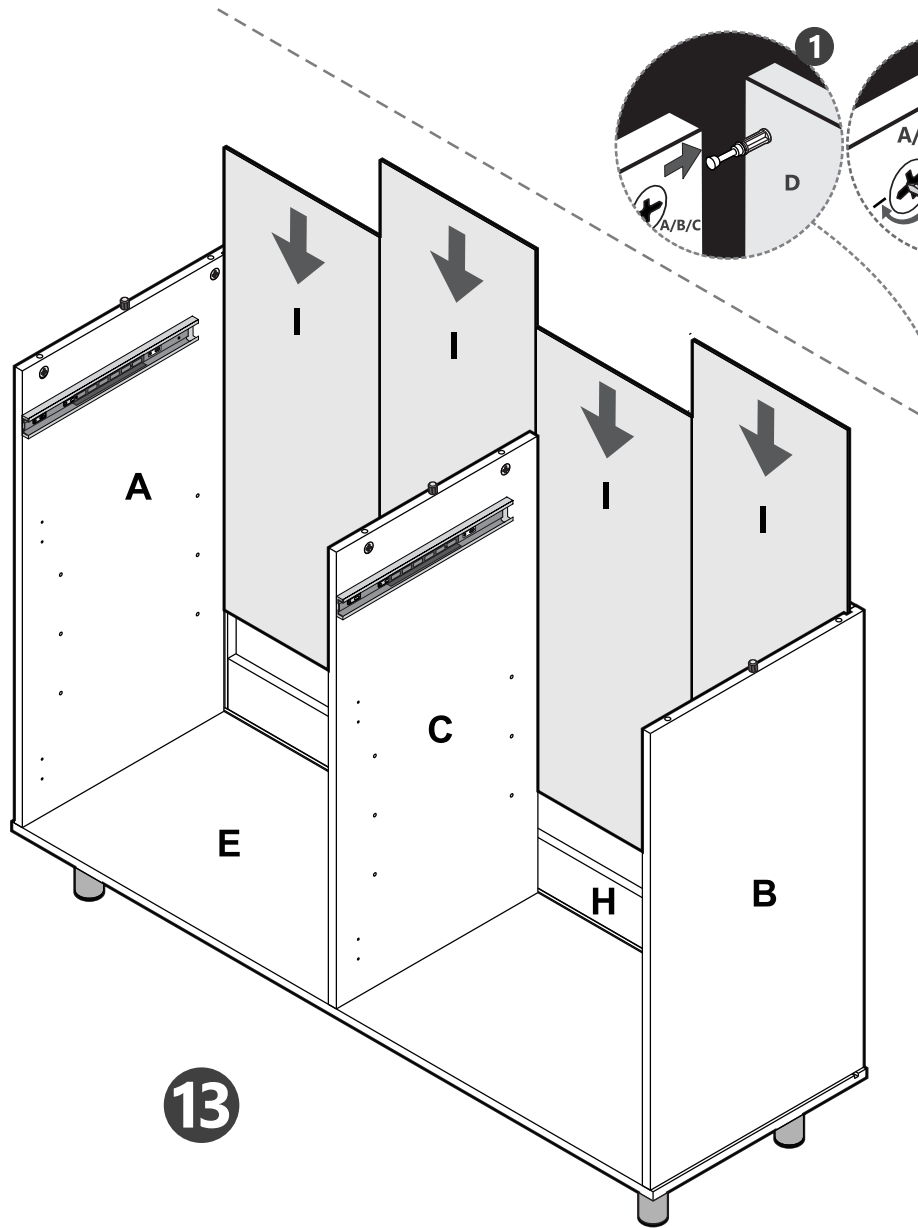

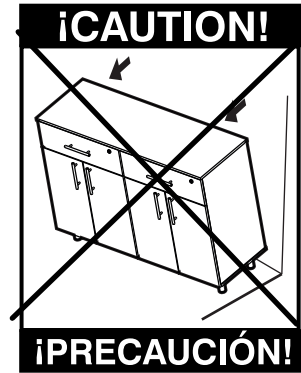

15

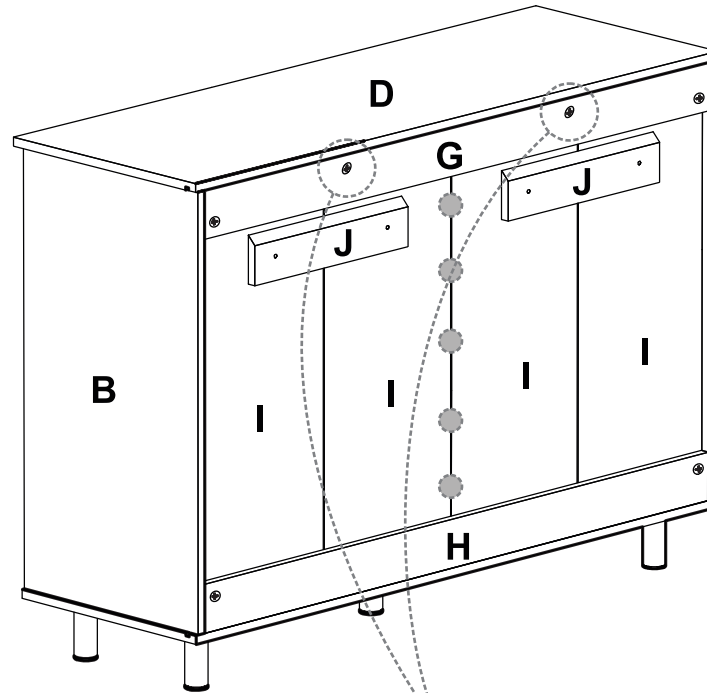

For the cabinet installation, please read the instructions sheet carefully/  
Para la instalación del gabinete, por favor leer la hoja de instrucciones detalladamente.

PRECAUCIÓN

CAUTION

WALL / MURO

To fix the furniture, drill the wall using a (tungsten) 5/16" drill, then insert the plastic anchor. Secure the furniture using the anchor screws.

Para fijar el mueble, perfora la pared con ayuda de una broca para pared (tungsteno) 5/16", después introduzca el chazo plástico (# 10) asegure el Mueble con tornillos chazo (#9).

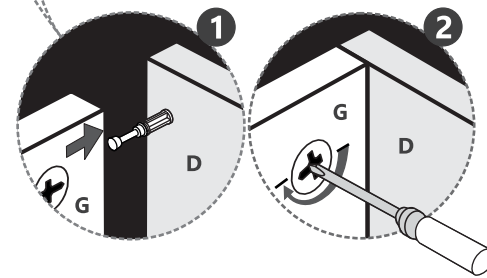
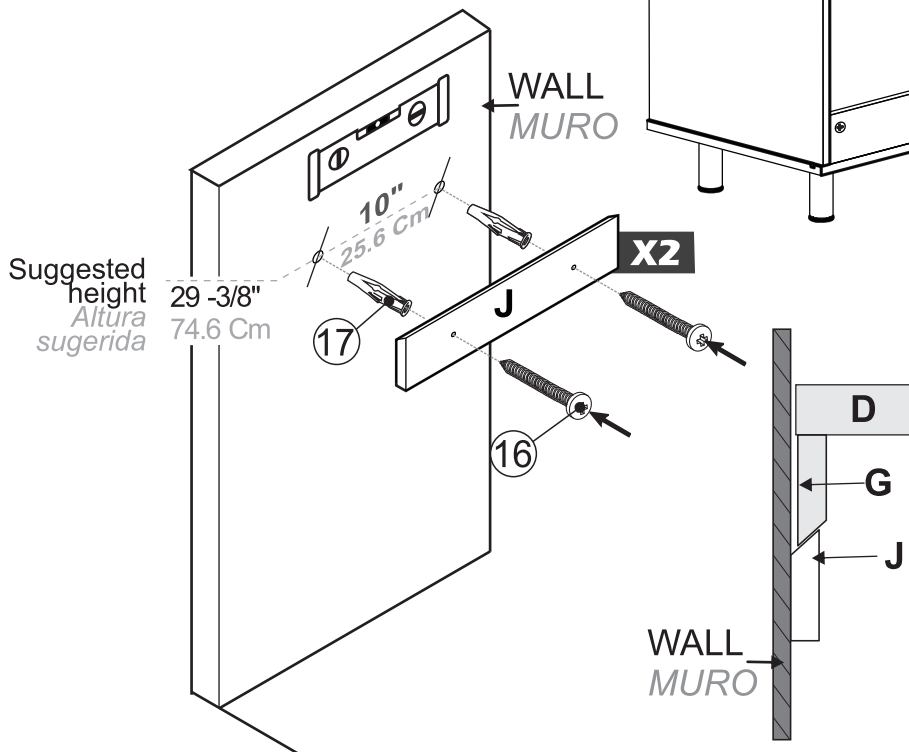

ANCHOR/ CHAZO

To use this type of anchor, the walls must be made of solid concrete and brick. If doubt, contact your nearest hardware store.

Para el uso de estos chazos de anclaje, las paredes deben ser solidas, de cemento y ladrillo. Si no, contáctese con su ferretería más cercana.

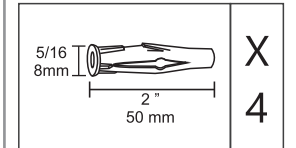

17 WALL ANCHOR / CHAZO ANCLA

|   |                  |
|---|------------------|
|   | X                |
| 10mm                                    | 2 1/2" / 63.5 mm |
| 4                                       |                  |
| <b>16 WALL SCREW / TORNILLO A PARED</b> |                  |

|                                     |            |
|-------------------------------------|------------|
|                                     | X          |
| 5/16 8mm                            | 2" / 50 mm |
| 4                                   |            |
| <b>17 WALL ANCHOR / CHAZO ANCLA</b> |            |

|                             |   |
|-----------------------------|---|
|                             | X |
|                             | 5 |
| <b>18 NAILS / PUNTILLAS</b> |   |

|  |   |
|--|---|
|  | X |
|  | 5 |
| <b>19 NAIL WASHERS / ARANDELA ESTRELLA</b> |   |

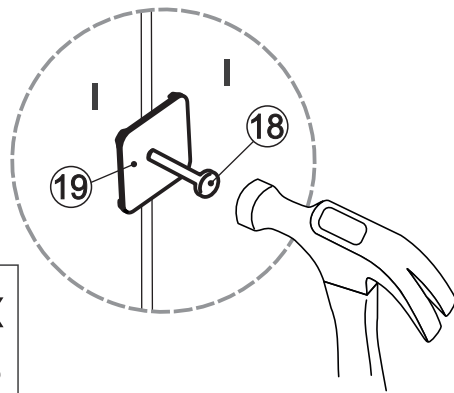

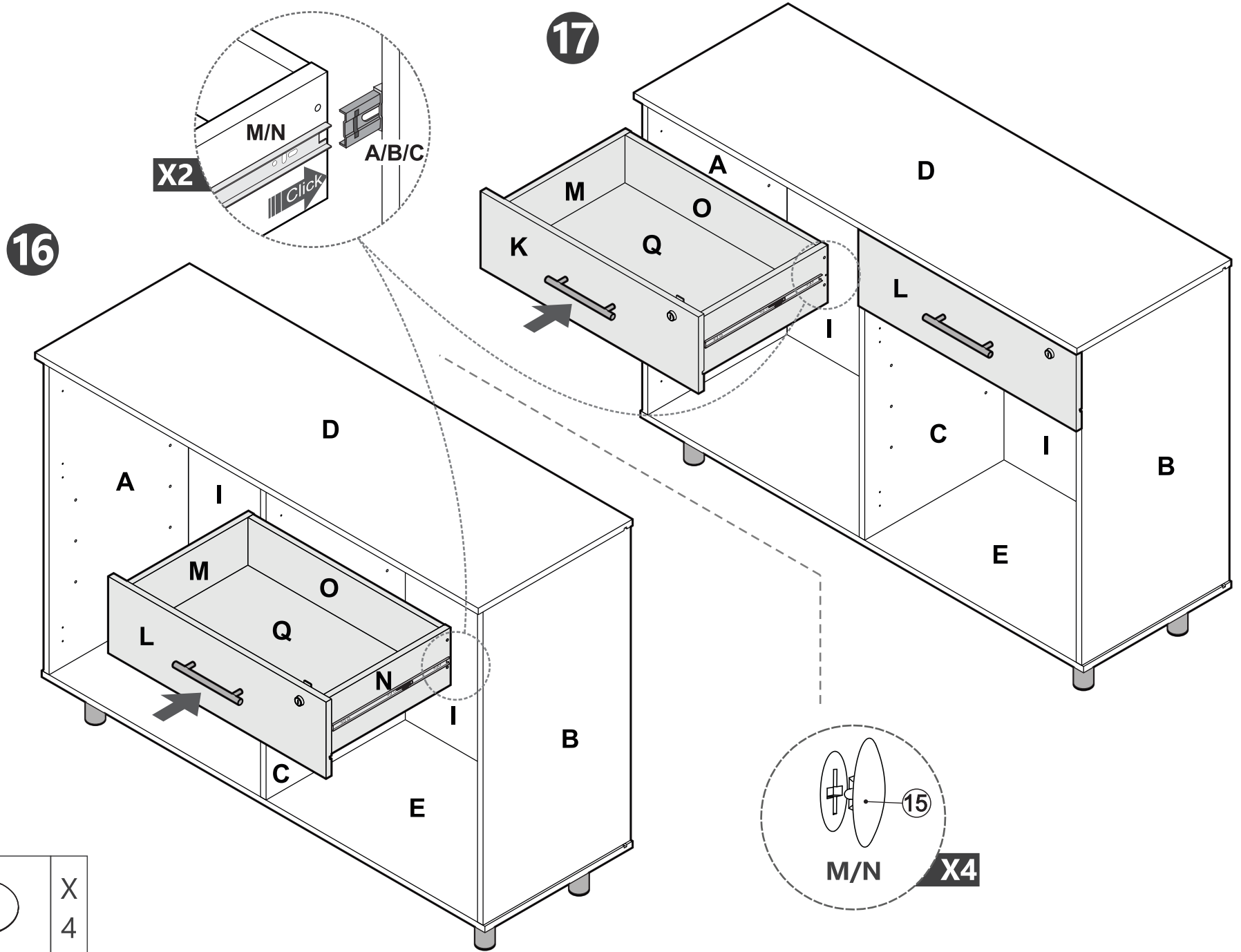

|  |        |
|--|--------|
|  | X<br>4 |
| <b>15</b> CAM CAPS<br>TAPA TUERCAS   |        |

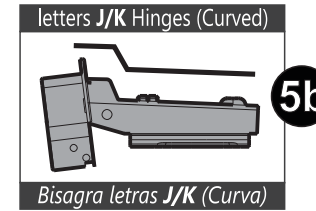
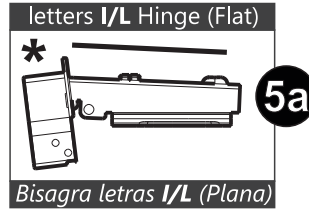
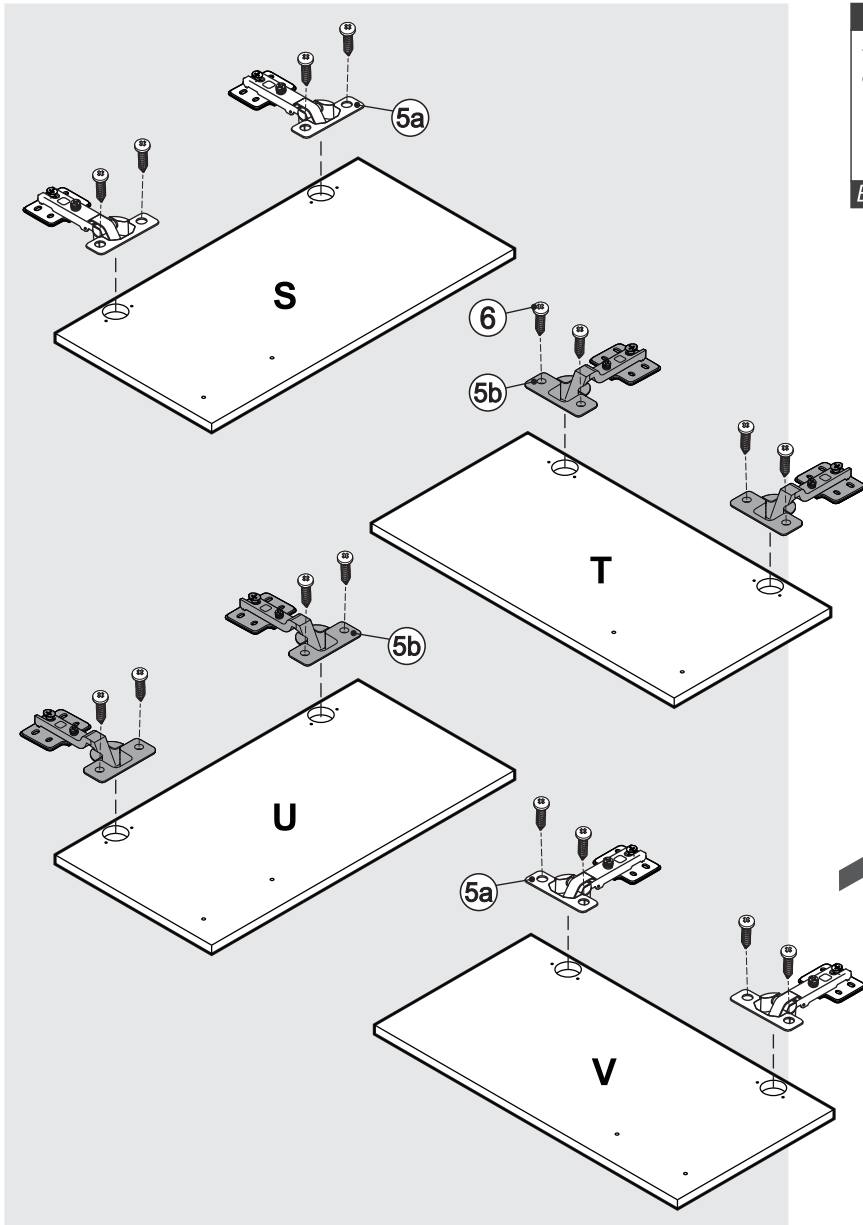

Hinges Assembly



Armado de Bisagras

**18**

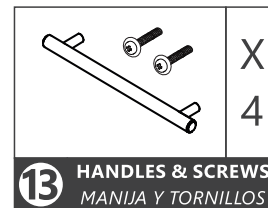
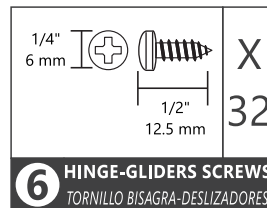
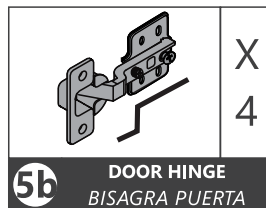
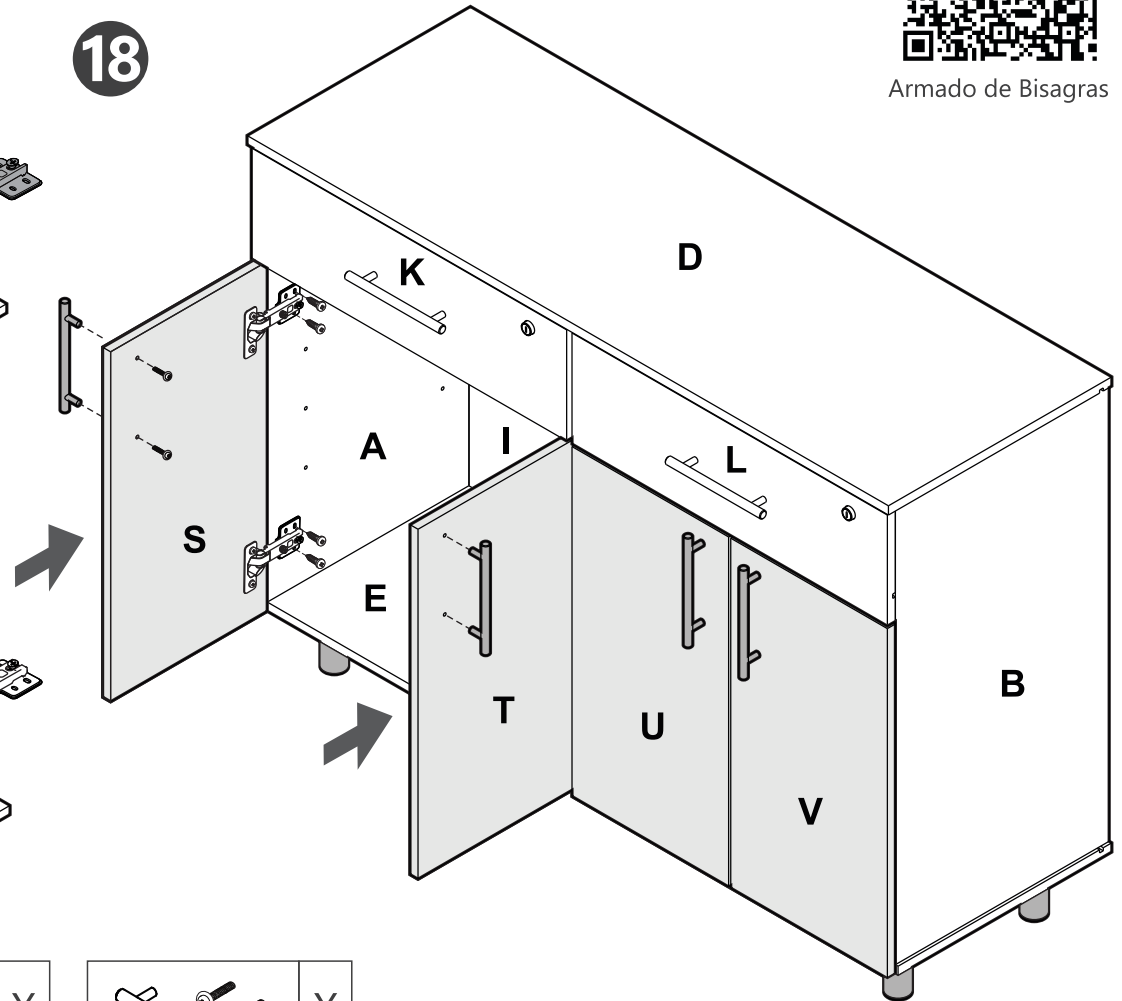

Loosen or tighten the indicated screw to **ADJUST HEIGHT.**

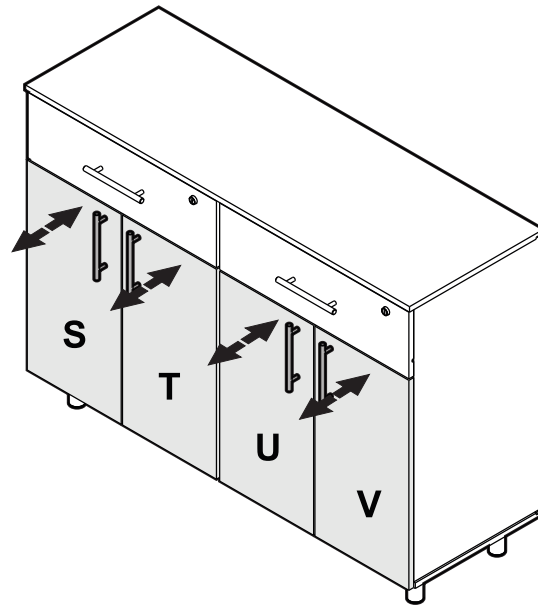
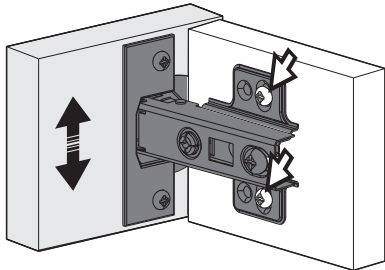

Loosen or tighten the indicated screw to adjust **SIDE AND GAPS ADJUSTMENT.**

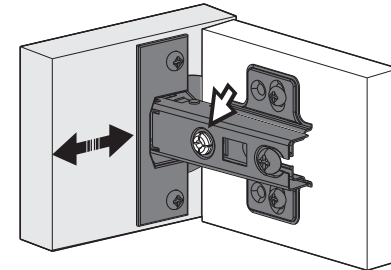

Loosen or tighten the indicated screw to **ADJUST DEPTH.**

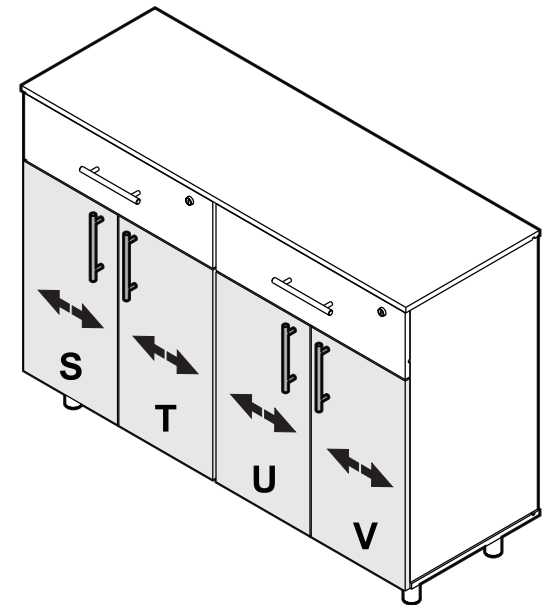
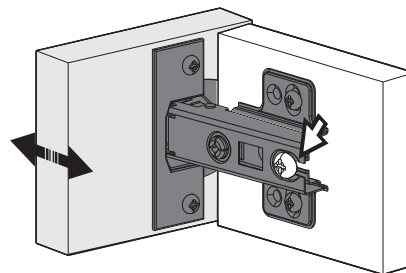
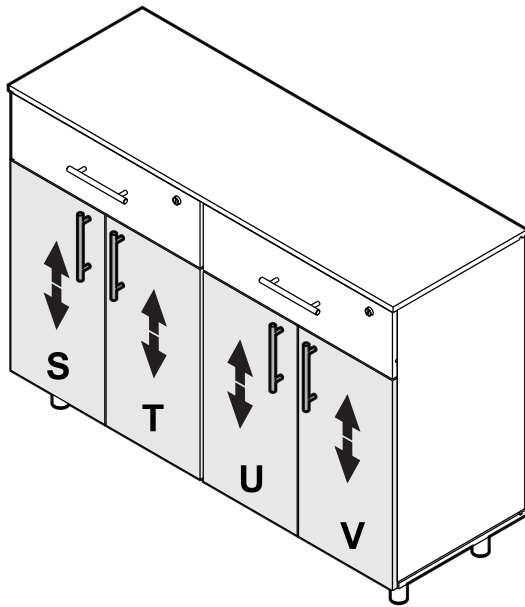

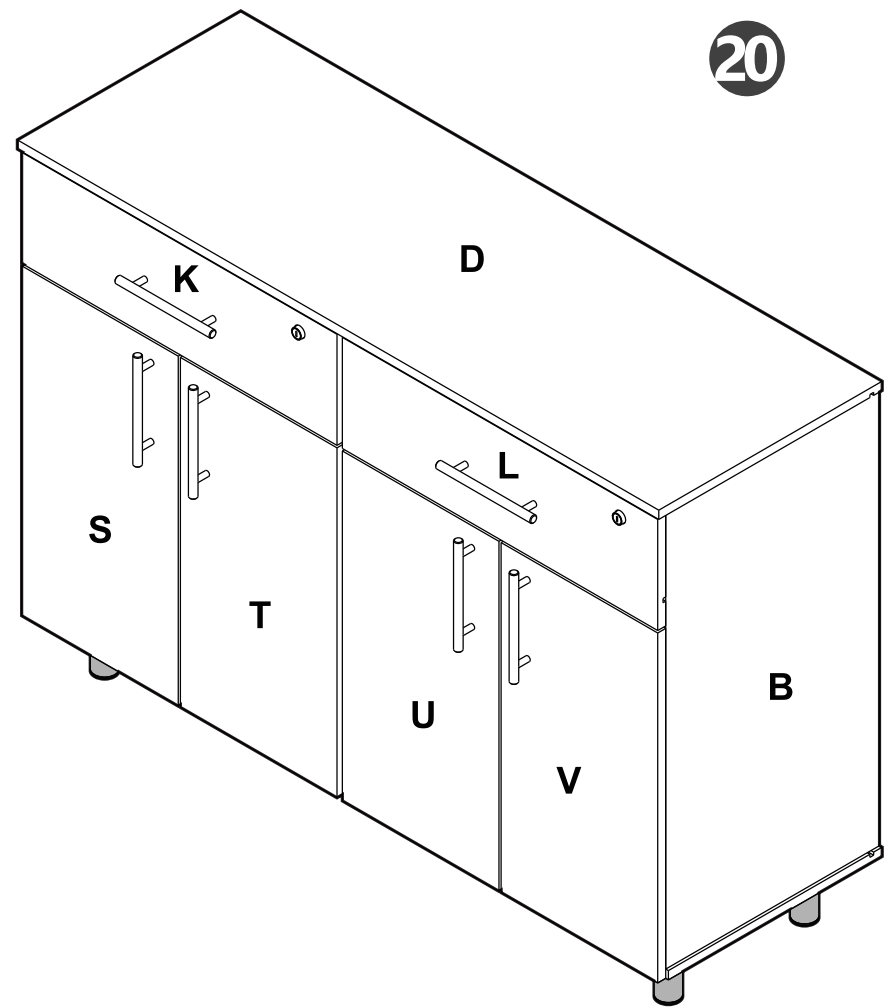
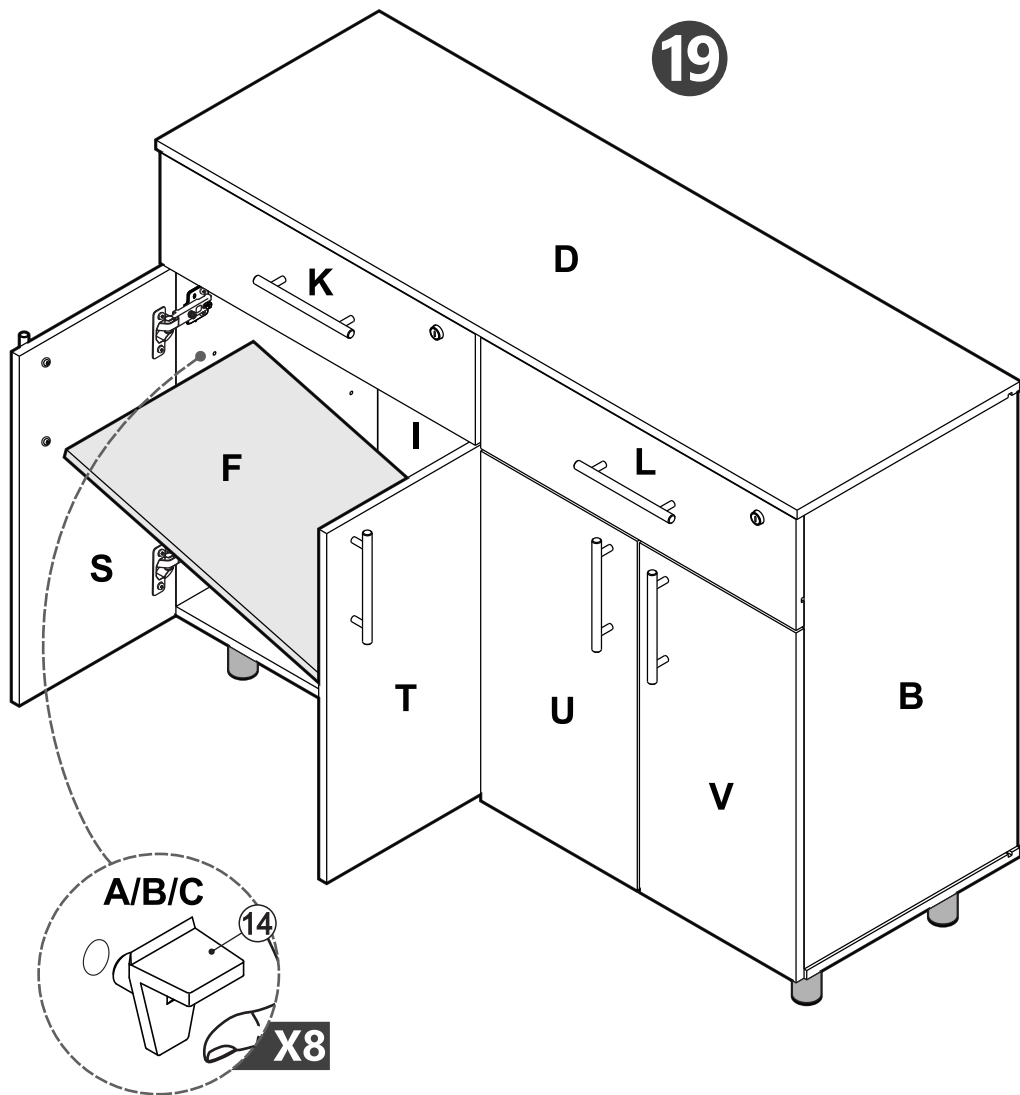

**CONGRATULATIONS!**, this way you finished assembling your furniture.

**¡FELICITACIONES!**, de esta manera usted termina de armar su mueble.

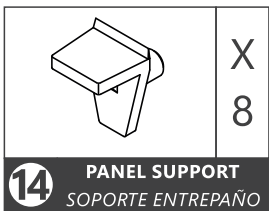

**14** PANEL SUPPORT  
SOPORTE ENTREPAÑO