

THE COUCH

INSTRUCTION MANUAL

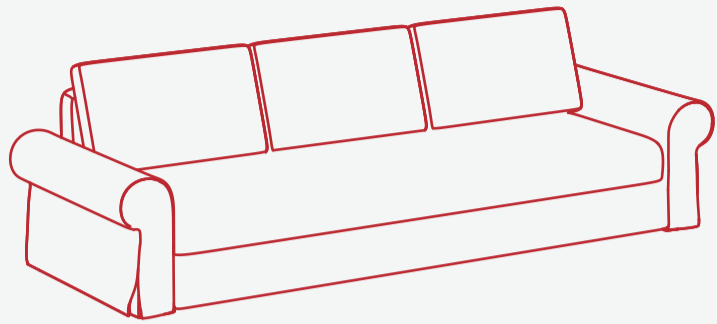

ULTIMATE COZY COMFORT

TIPS & PREP

Your new couch comes with easy assembly that you can do at home using the provided instructions. But before we dive in, here are some key tips and prep steps to make the assembly process as smooth as possible.

Get a buddy or family member

Even though the assembly is completely tool-free, it involves lifting and aligning various parts. To make assembly easier, we suggest having at least two people there throughout the process.

Left or right matters!

Throughout assembly, we'll mention the Left and Right Arm Panels and movements to the left and right. We'll be using 'left' and 'right' based on the perspective of standing in front of your couch.

Don't overlook the glossary!

We've included a glossary with these instructions to help you identify every part and piece of hardware. If you run into any issues, consult the glossary to ensure you're using the right components.

Unbox and check your hardware

The hardware pack for your sofa is in the seat base. Open it up, lay out each piece, and double-check with the checklist to make sure you have everything you need. If anything's missing, reach out to customer service before moving forward.

Have your scissors handy!

Make sure you have scissors nearby. The cushions and seat pads are in compression bags. Carefully open them to prevent any damage or injury while unpacking.

Clear the space!

We recommend putting your couch together in a roomy, clutter-free area, away from pets and little ones. Lay down a sheet to keep the couch components clean and free of debris during assembly.

PRODUCT LIST

Complete parts list for your couch. The couch ships in three boxes—Box 1, Box 2 and Box 3. Confirm both boxes arrived and use this list to check all parts.

Box 1 and Box 2 and Box 3

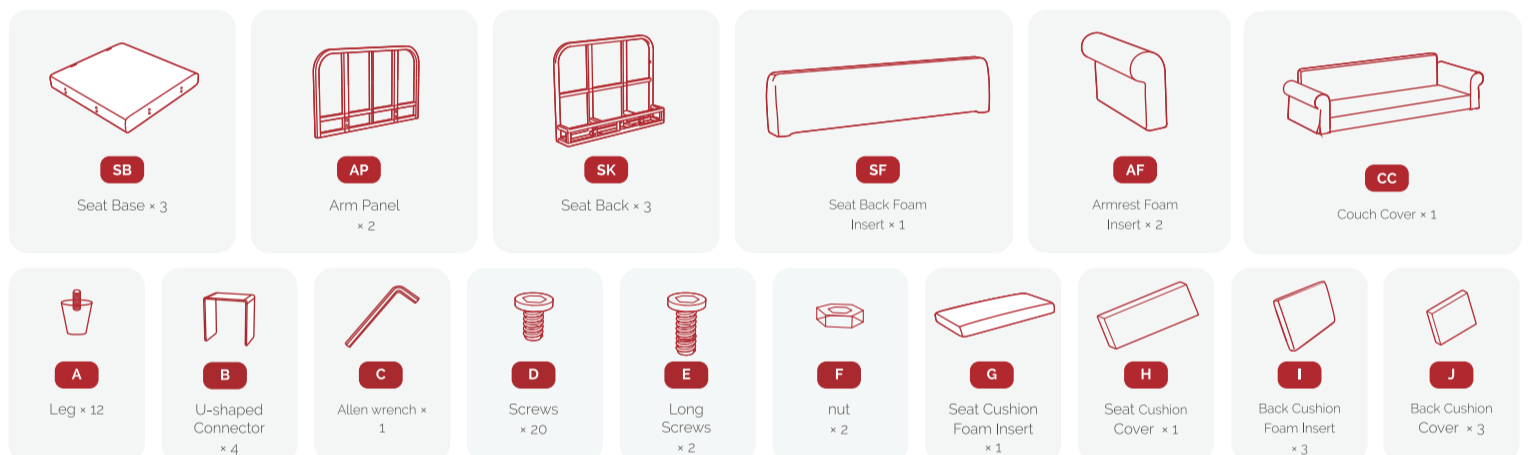
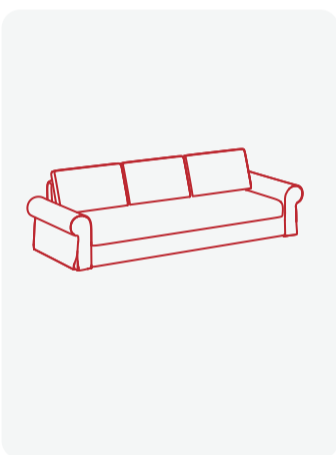

COUCH ASSEMBLY INSTRUCTIONS

NOTICE:

Don't worry, it may take at least 72 hours for all compressed foam to fully regain its shape after decompression.

STEPS

1. Ensure both packages have been received before starting assembly.
2. Carefully check the quantity of products in the packages. Contact us at any time if there are any quantity or quality issues.
3. During unboxing, use scissors with caution to avoid scratching yourself and the products.

Don't worry, it may take at least 72 hours for all compressed foam to fully regain its shape after decompression.

During the process, firmly pat all the foam and cushions to help accelerate the foam's recovery.

NOTICE:

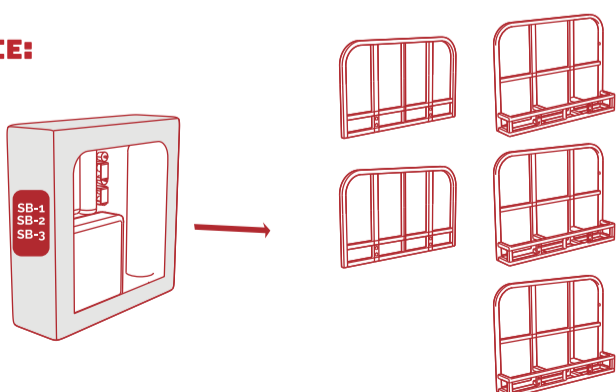

Please note that the Seat Base contains a set of components. Unzip the bottom of the Seat Base (SB-1, SB-2 and SB-3), remove the necessary components.

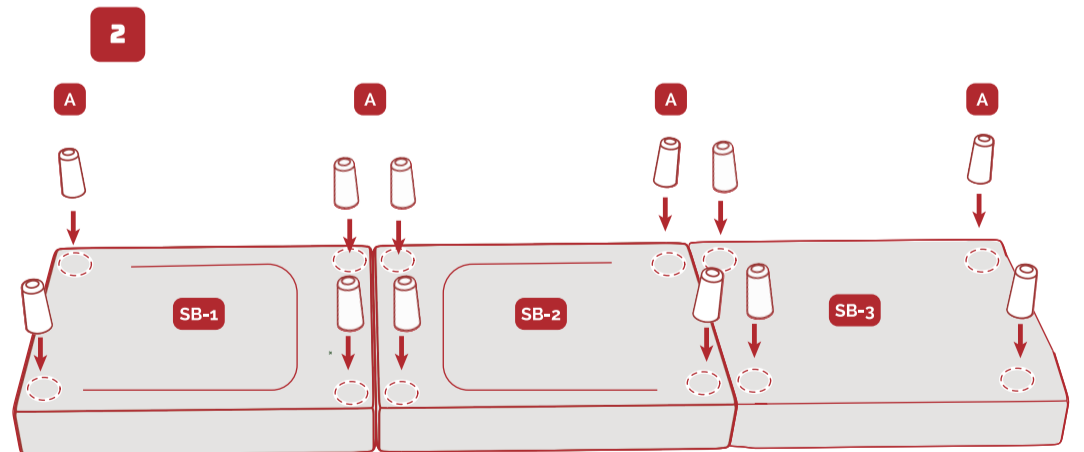

Install the legs(A) separately onto the seat base(SB) (12 legs)

All legs should be screwed in clockwise.

3 Assembly Steps for the Couch Frame.

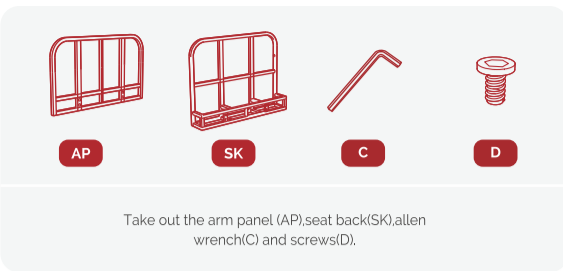

Take out the arm panel (AP), seat back(SK), allen wrench(C) and screws(D).

SB-1,2,3

Please confirm the installation direction according to the screw holes on the seat base.(SB)

Please note the direction and position of the side connecting holes.

Please note that the screw holes should align with each other.

Please tighten the screws from the outside to secure the seat back(SK) and arm panel (AP) to the seat base(SB).

Please tighten the screws from the outside.

4 Assembly Steps for the Couch Frame.

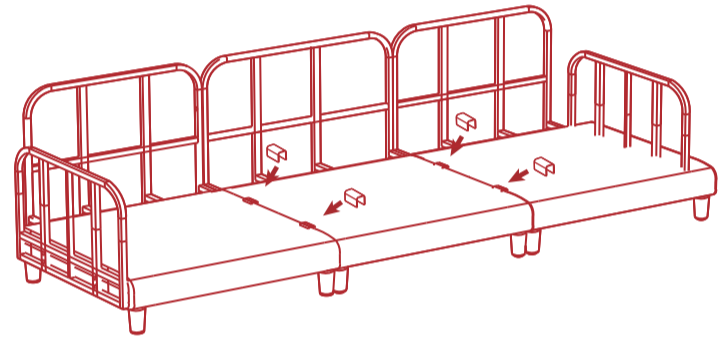
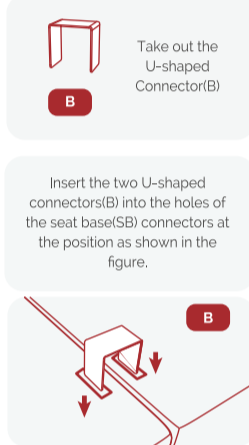

5 Assembly Steps for the Couch Frame.

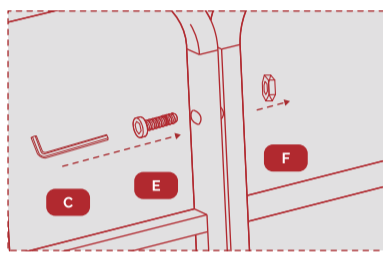

Secure the two seats with the long screws at the position as shown in the figure.

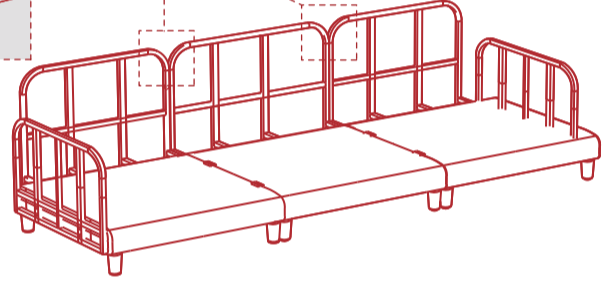

6

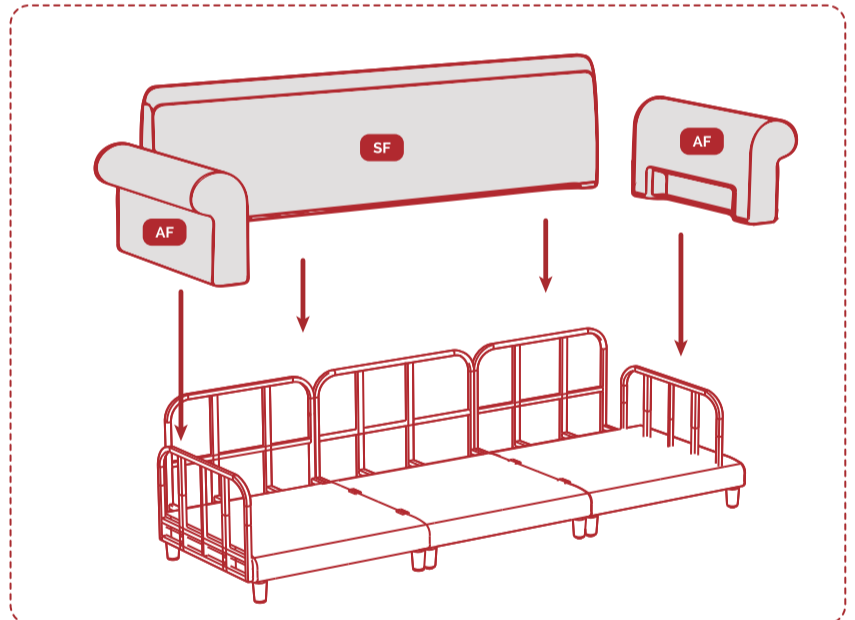
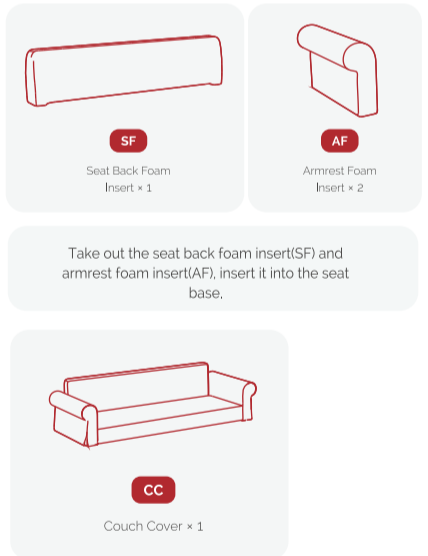

7 Assembly Steps for the Couch cover.

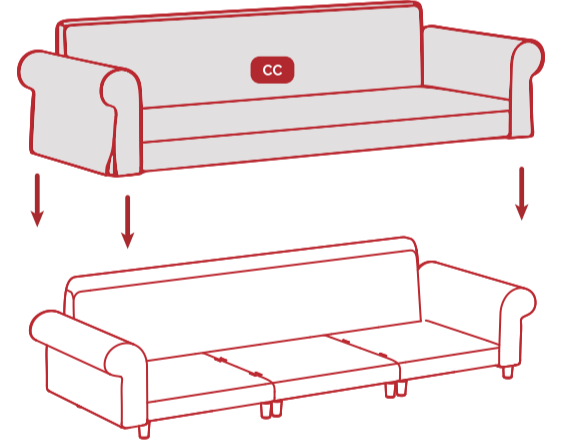

8

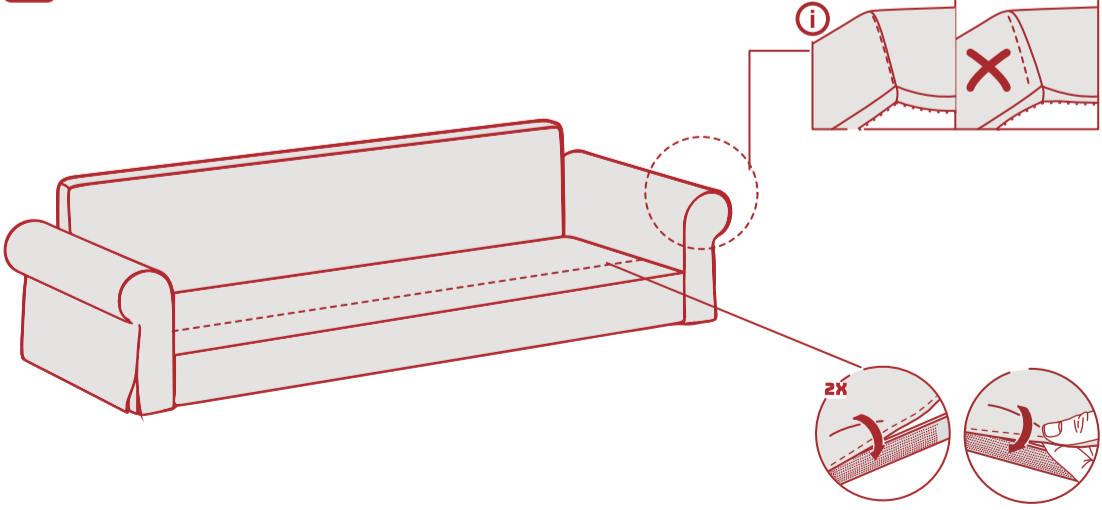

9

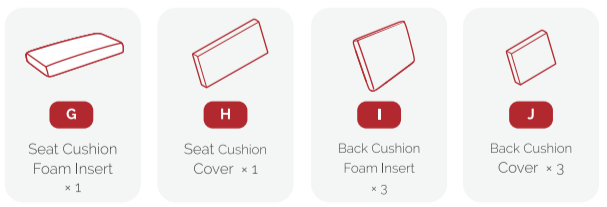

Take out and help the foam regain its shape by gently patting it repeatedly.

10

Assembly Steps for the Cushion.

Fit the cushion cover(H) and back cushion cover(J) over the corresponding foam(D,C).

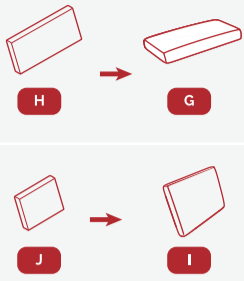

NOTICE:

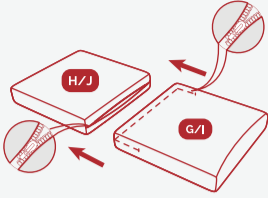

Note:
When installing the back cushion foam insert(G/I), first locate the zipper on the cushion cover(H/J), then insert the cushion foam insert(G/I) into the cushion cover(H/J).

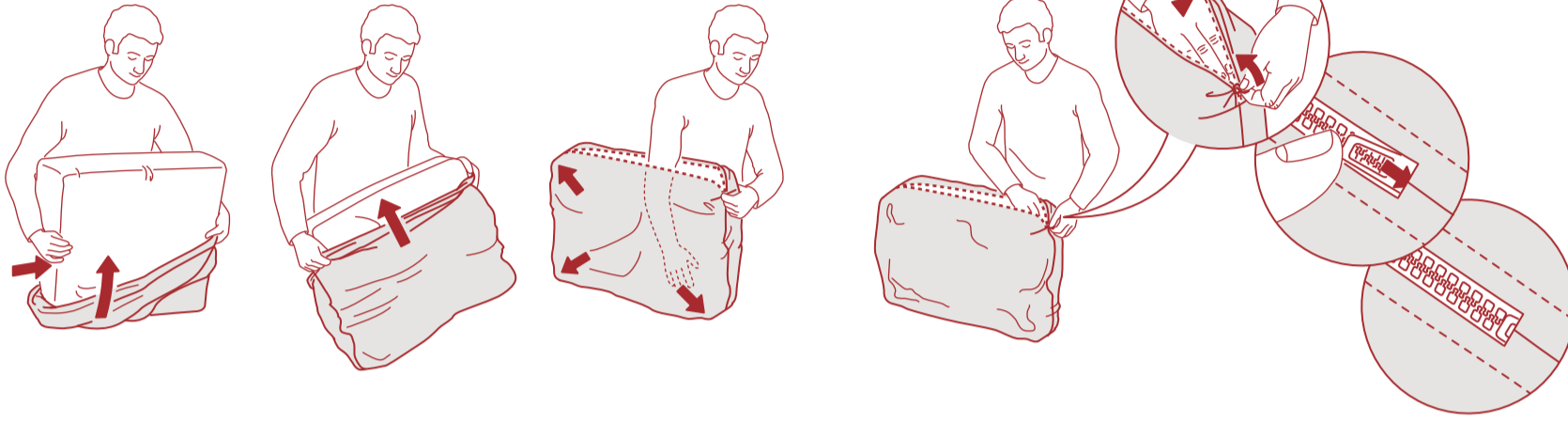
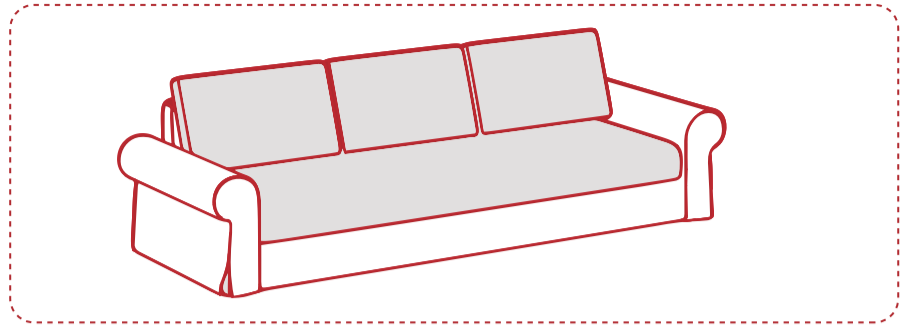

11

Complete the installation.

