

T1 Bitte unbedingt ausfüllen!

Name _____

Strasse _____

PLZ _____ Ort _____

TeL. _____

T2 Sehr geehrte Kunden,
wir freuen uns, dass Sie sich für ein Produkt aus dem Hause entschieden haben. Sollte es trotz aller Bemühungen unsererseits, Ihnen ein qualitativ hochwertiges Möbelstück zu liefern, zu Fehlteilen kommen, schicken Sie bitte dieses ausgefüllte Blatt an

Bitte beachten Sie, dass Bauteile über 800mm Länge und 350mm Breite direkt bei Ihrem Möbelhändler zu beanstanden sind. Zur Reklamationsbearbeitung ist es unbedingt erforderlich **die Artikelnummer des Schrankes**, welche auf dem Etikett ersichtlich ist und den Markt, wo das Möbel erworben wurde anzugeben. Außerdem tragen Sie unten bitte die benötigte Stückzahl ein. Viel Spaß mit Ihrem neuen Badmöbel!

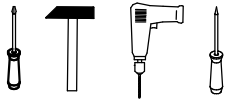

T3 Für den Zusammenbau sind 2 Personen erforderlich.

T4 Montage-Richtzeit 3 Stunden

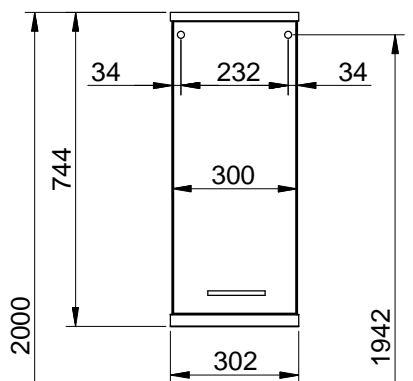

Fußboden

Die Maßangabe der Höhe ist nicht bindend!

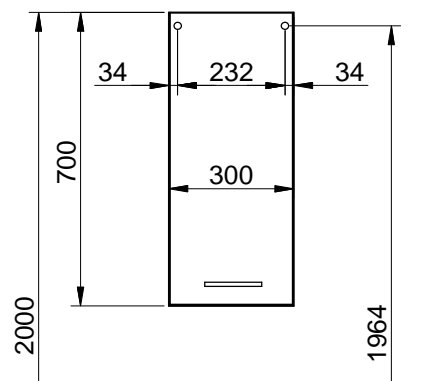





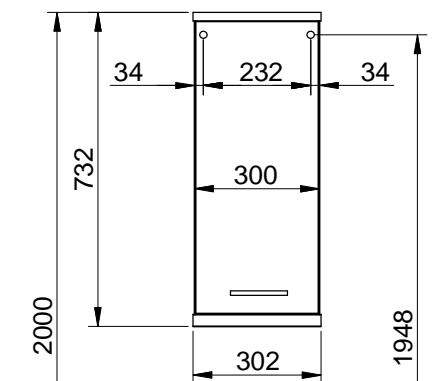





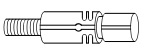

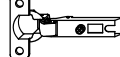
Fußboden

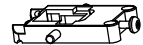
Die Maßangabe der Höhe ist nicht bindend!

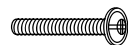

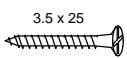
Fußboden

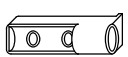
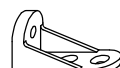
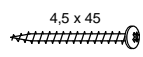
Die Maßangabe der Höhe ist nicht bindend!

8 x a  DUEB-SMD-000005	Stück	8 x b  EXZENTER-000015	Stück	2 x c  ZPL-003X004	Stück	2 x d  TBD-35-115X00	Stück	<div style="border: 1px solid black; padding: 2px;"> A4 Datum </div>	
2 x e  AUF-001-000020	Stück	8 x f  TRAE-001-000020	Stück	2 x g  AUF-001-000060	Stück	1 x h  Griff	Stück	2 x j 	Stück
6 x k  SCH-SPA-035X015	Stück	10 x l  NAGEL-025X001	Stück	4 x m  SCH-SPA-035X025	Stück	2 x n  ADK-__1-005X008	Stück	1 x o 	Stück
1 x p  TUER-ADA-000010	Stück	1 x r  VBD-000020	Stück	1 x s  SCH-RDK-045X045	Stück	1 x t  SCH-RDK-040X015	Stück	2 x u  ADK-AL1-005X008	Stück

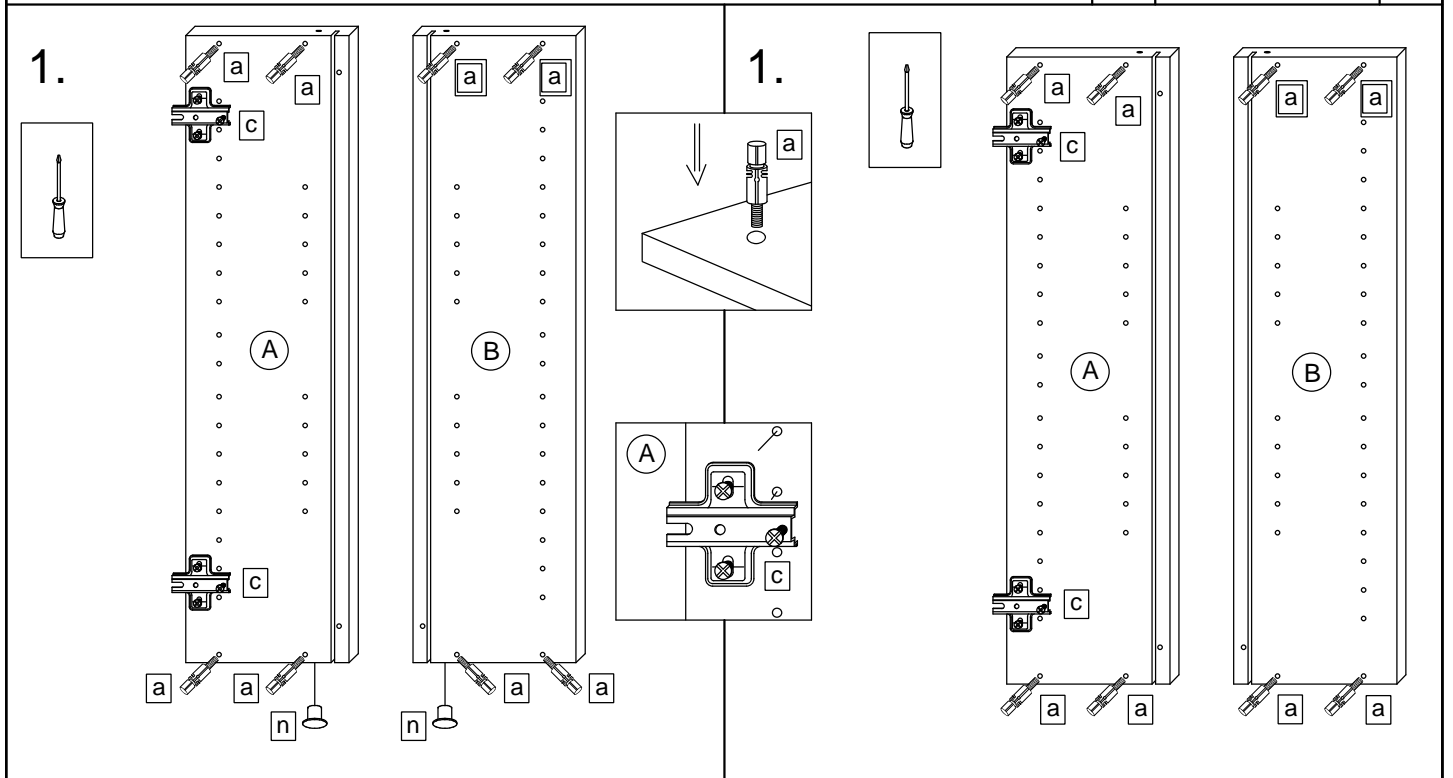
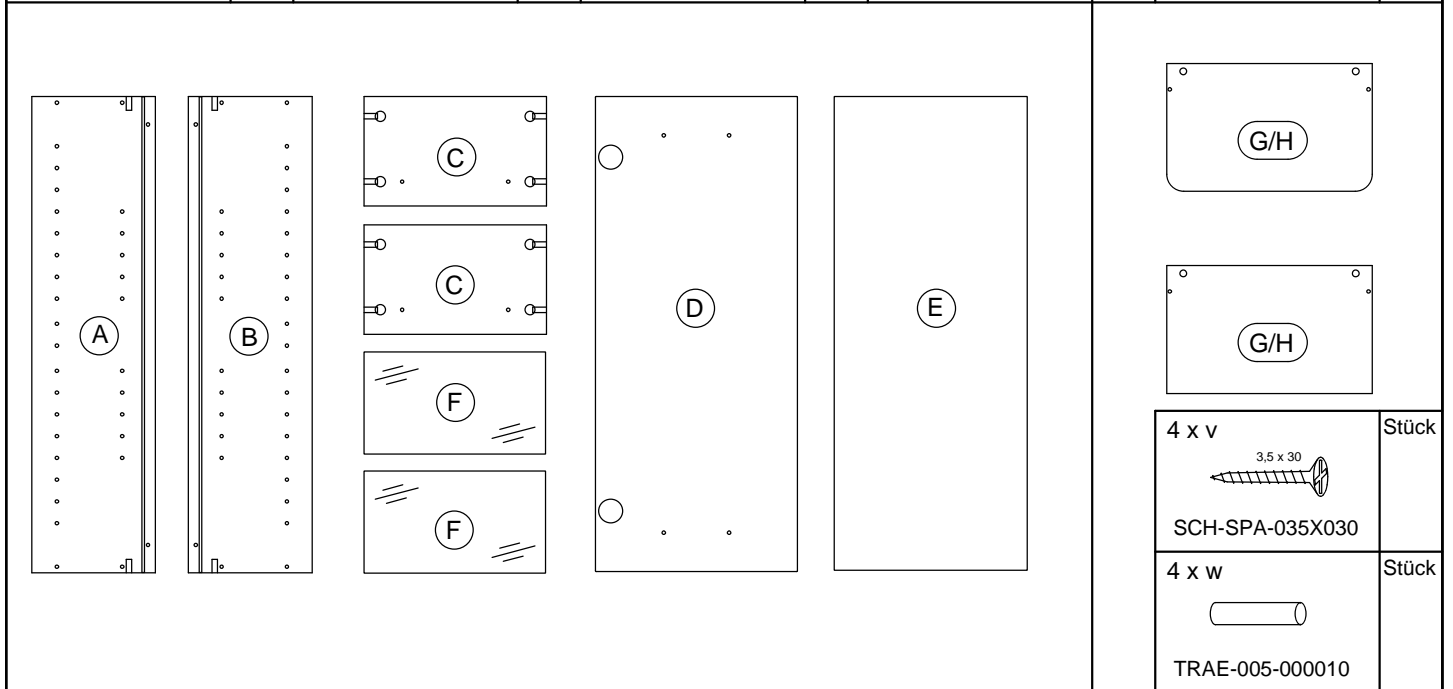

2.

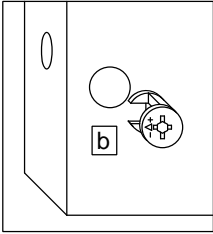
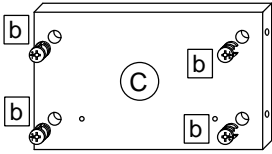
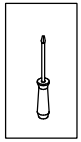

2.

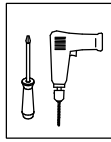

2.1

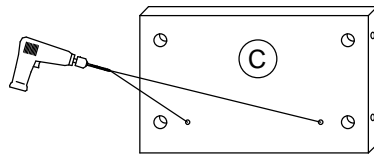
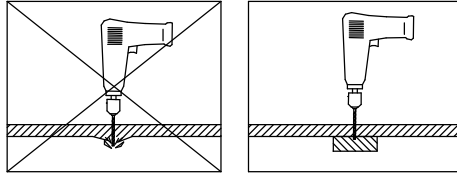

2.2

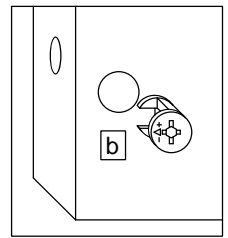
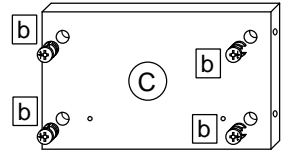

3.

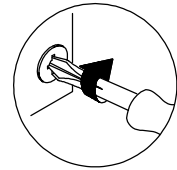
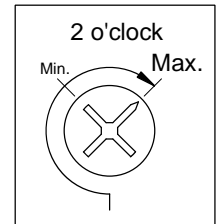
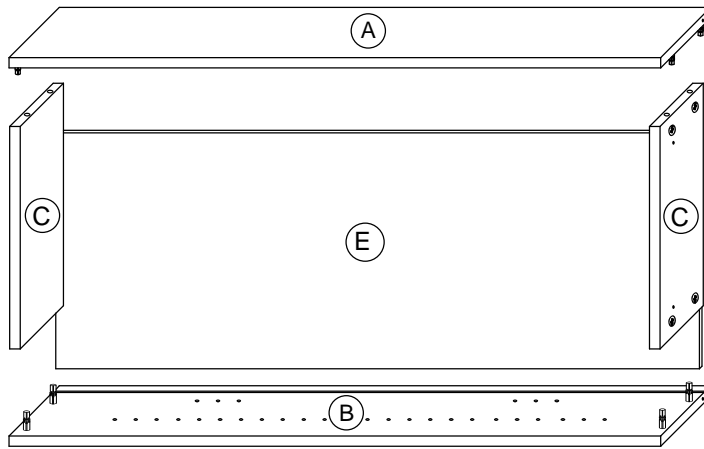
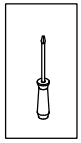

4.

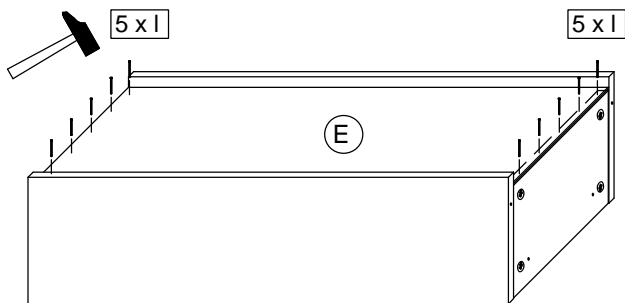
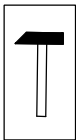

5.

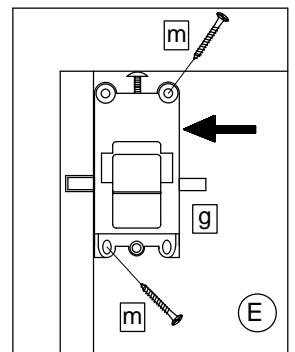
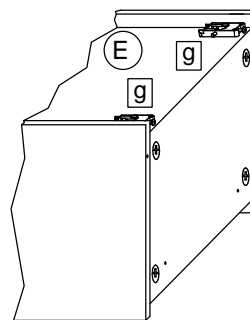
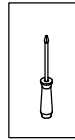

6. 6.1

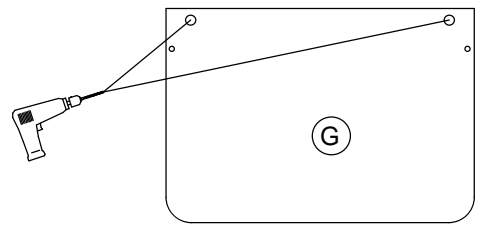
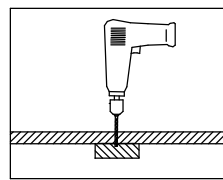
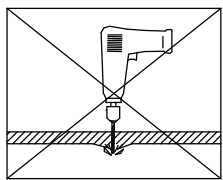
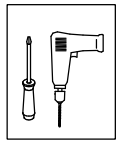

6.2

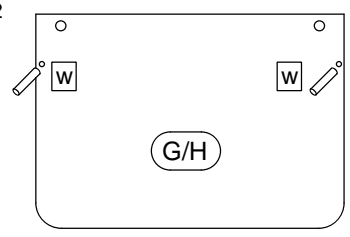

7.

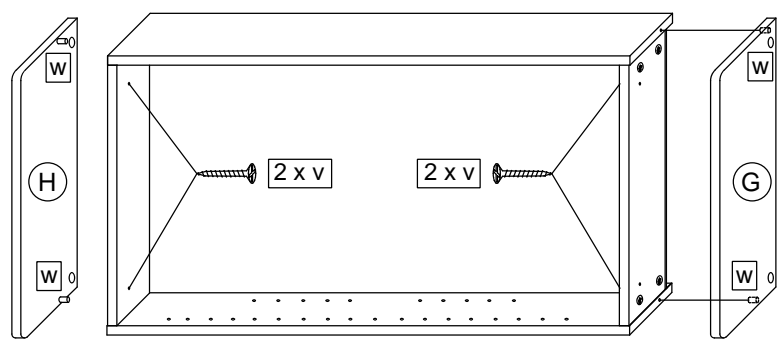
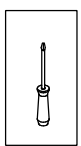

8.

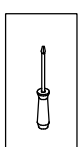

T9 Lassen Sie den Schrank nur durch fachkundige Personen mit für die Wand geeignetem Montagematerialien montieren.

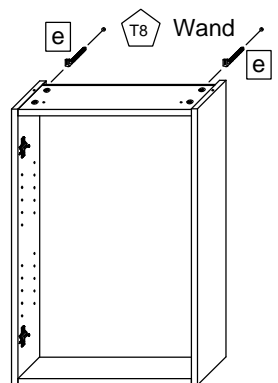
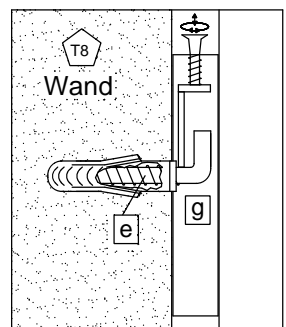

9.

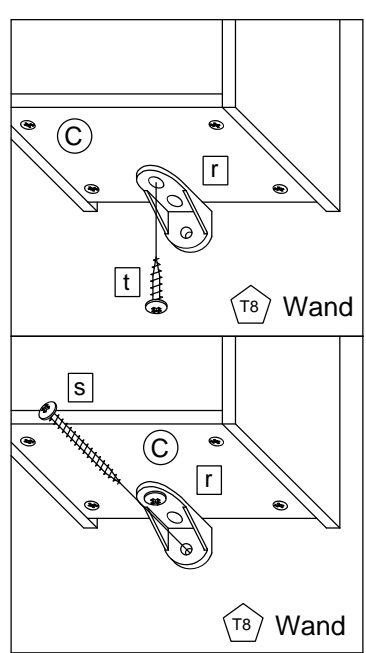
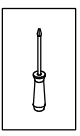

9.

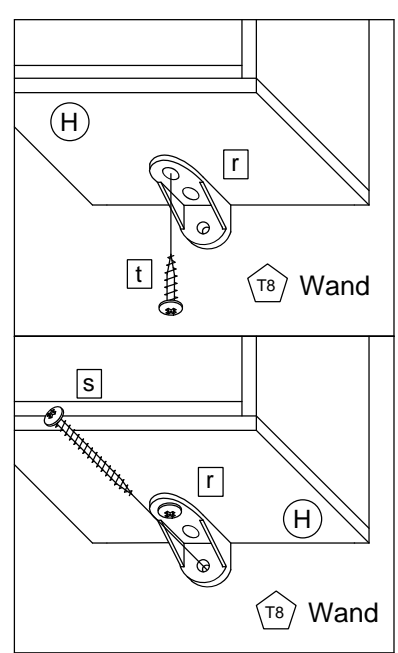
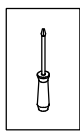

10.

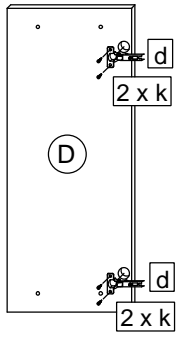
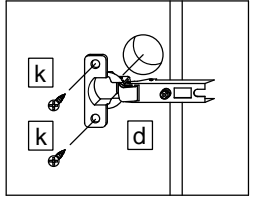
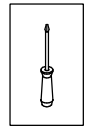

11.

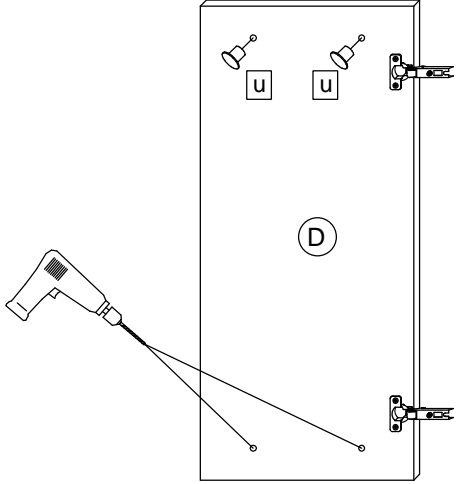
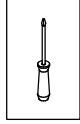

11.1

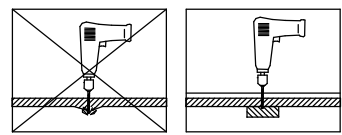

11.2

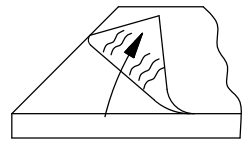

Bei Hochglanz-Fronten bitte erst die Schutzfolie entfernen und dann den Griff montieren!

11.3

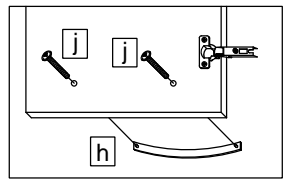

12.

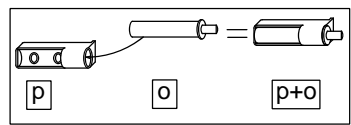
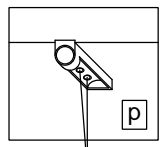
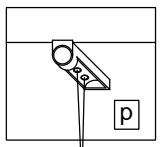
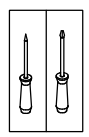

2 x k
(3,5x15)

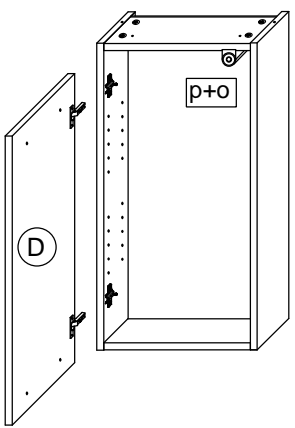

Bei Türmontage das Scharnier einhängen, bis Anschlag öffnen und anschließend festschrauben.

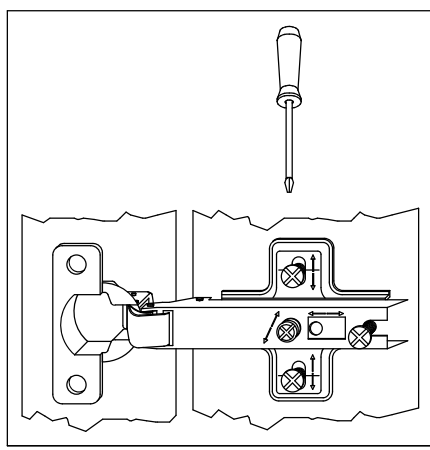
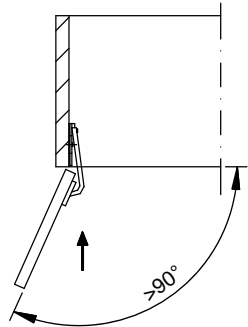

13.

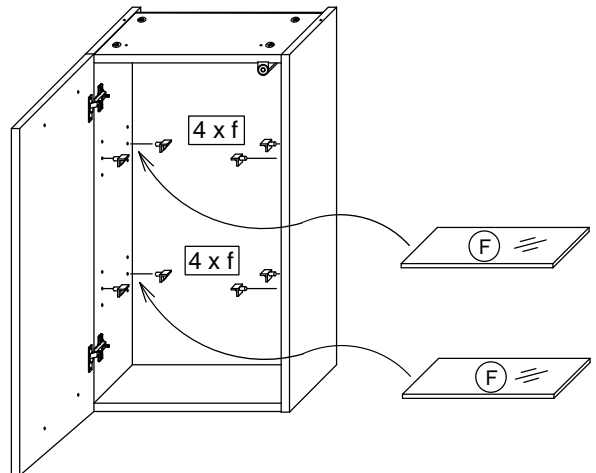

Das Möbel bitte nur mit einem feuchten Tuch reinigen.