









# Assembly Instructions

**Caution: You must read this before you proceed.**

## Care & Maintenance

- ⊘  ● Not for commercial use. For residential use only.
  - ⊘  ● Do not put hot items directly on furniture surface.
  - ⊘  ● Do not clean furniture with harsh cleansers or polish.
  - ✓  ● To obtain the longest lifespan of your outdoor products, minimizing exposure to direct sunlight is recommended.
  - ⊘  ● Children should not climb or jump on the furniture.
  - ⊘  ● Do not write on furniture without a padded barrier to protect the surface.
  - ✓  ● To obtain the longest lifespan of your outdoor products, avoid extended and lengthy exposure to rain, snow, and direct sunshine. Whenever possible cover the product and /or place under patio or awnings.
  - ⊘  ● Stains may be removed with mild soap solution and damp cloth.
- 
- ✓  ● Dust and pick-up spills using a clean, non-colored, lint-free cloth.

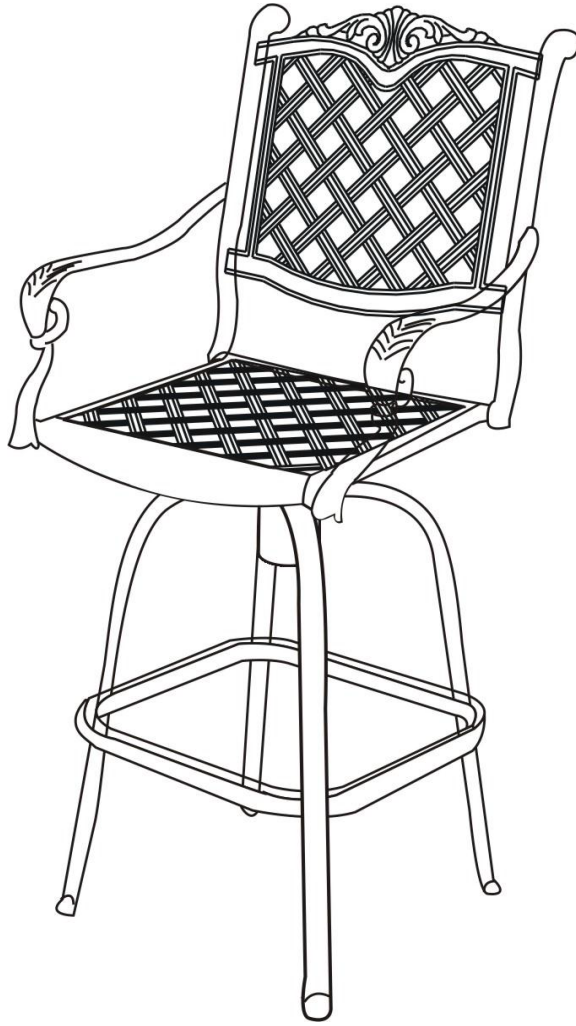

# Swivel Barstool





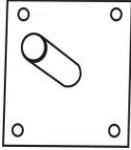

**CAUTION : This barstool is NOT a TOY.  
Keep your child / children at bay in the process of assembly.**

## Parts List

No.	Picture	Description	Qty
A		Chair Seat	1

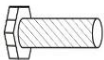
B		Iron Plate	1
C		Chair Leg base	1





## Hardware

No.	Picture	Description	Qty
①		Bolts(M8*20mm)	5
②		Washers ( 8mm )	5
③		Springs Washers ( 8mm)	5
④		Spanner	1

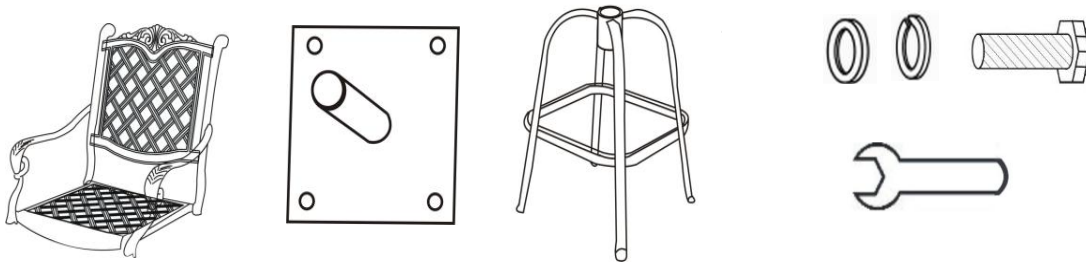
## Assembly Preparation

Before Beginning Assembly:



-  • Read instructions, cover to cover-
-  • Have 2 adults on hand for assembly-
-  • Do not assemble on flooring or carpet-
-  • Assemble on a clean non-marring surface (packing foam)-
-  • Save all packaging until finished-

## Assembly Steps

## Overview

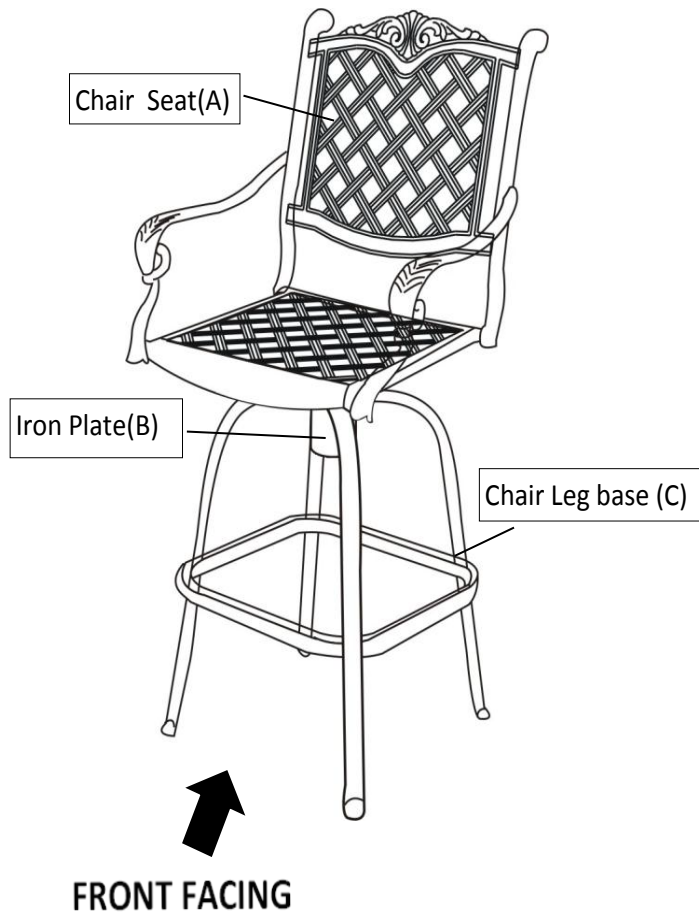

This Barstool has multiple parts and may require up to 30 minutes to assemble. To give you an overview of the Bed parts, the above picture is to help you put the various Bed parts into perspective. Please read through the instructions herebelow to familiarise yourself with the parts and steps before assembly.

## Step 1

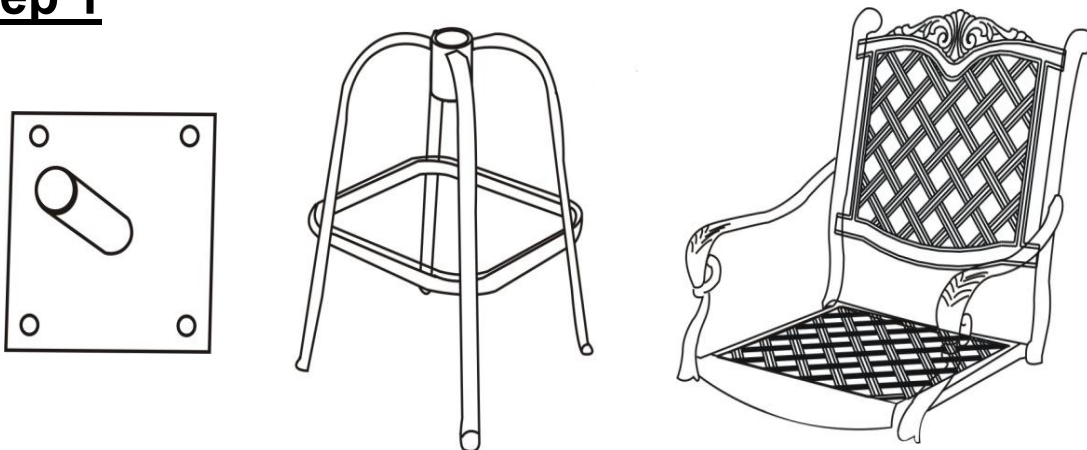

Place all parts on a clean soft surface.

## **Step 2**

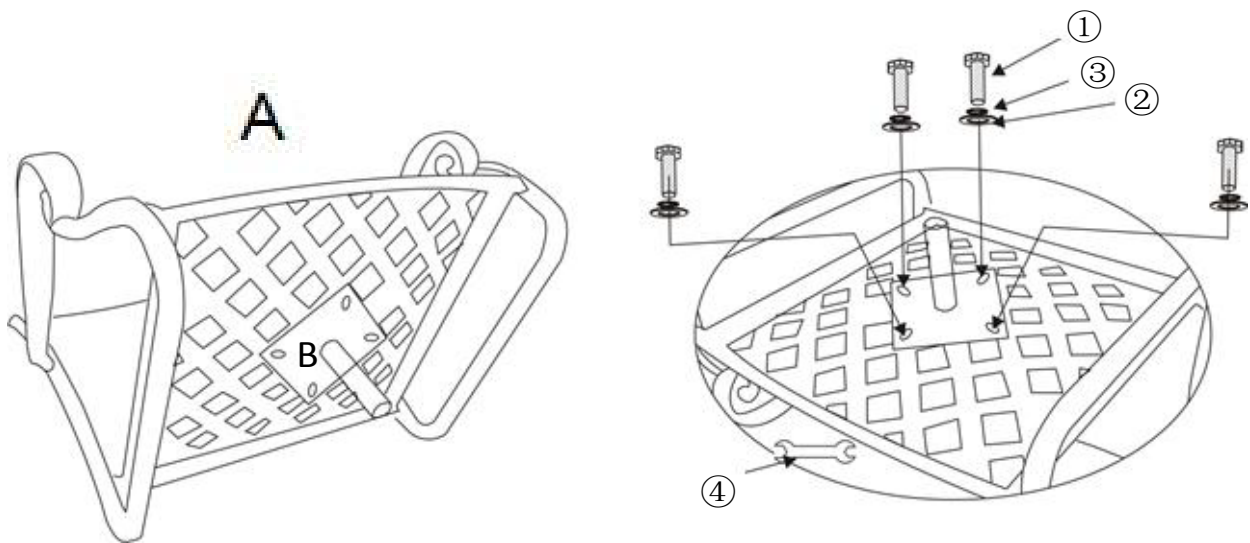

Attach the Iron Plate(B) to the underside base of the Chair Seat(A).  
Align the contact points on the bottom of the Chair seat(A) with the mountings on the Iron Plate(B).

Then, using the Spanner(④), attach the Iron Plate(B) to the Chair Seat(A) with Bolts(①), Flat washers(②) and Springs Washers(③).

**Do not over tighten yet.**

## **Step 3**

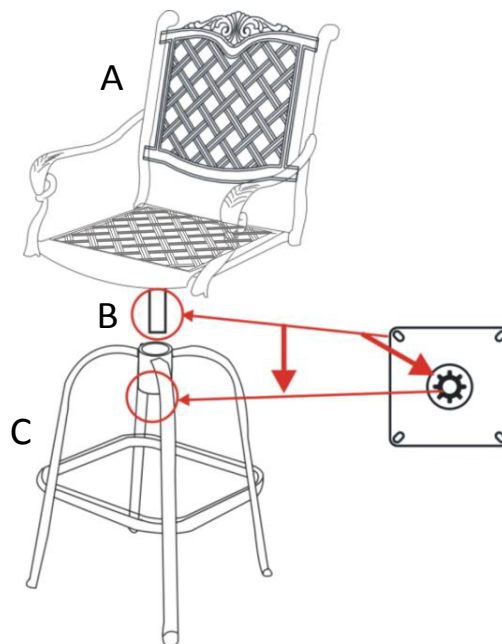

Attach the Chair Seat(A) with attached Iron Plate to the Chair Leg Base(C) as pictured above.

The Stem from the Iron Plate is to be aligned and fully inserted into the end of the Chair Leg Base Stem.

Once into its housing, exert force and weight on the chair seat so as to force the Chair Seat into a locking position into the Chair Leg Base stem.

## **Step 4**



Make sure that the Chair Seat and the Chair Leg Base is fully and firmly attached together as one complete piece.

**Your Barstool is ready for use.**

**Caution: This Barstool can only be used on a flat, level surface.**

## **Step 5**

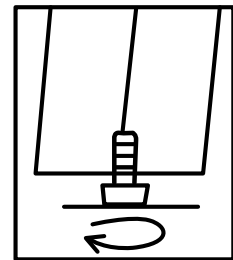
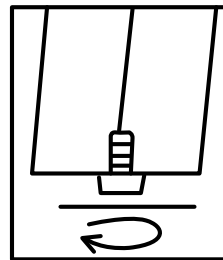
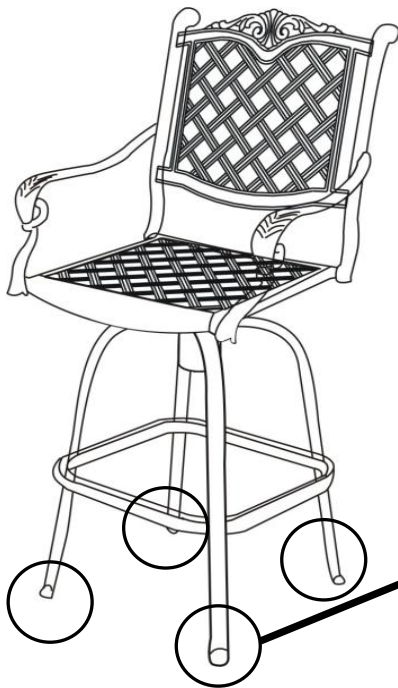

Adjust Pre-installed  
Levellers  
height for balance

Adjust the Pre-installed Levellers at the base of the Legs using the Table is level with the ground.