











Assembly Instructions

Caution : You must read this before you proceed

Care & Maintenance

- ⊘  ● Not for commercial use. For residential use only.
- ✓  ● Furniture may scratch floors. We recommend using furniture pads to protect your floors.
- ⊘  ● Do not put hot items directly on furniture surface.
- ⊘  ● Do not clean furniture with harsh cleansers or polish.
- ⊘  ● Do not place furniture under direct sunlight.
- ⊘  ● Do not place furniture near heating or cooling vents.
- ⊘  ● Do not write on furniture without a padded barrier to protect the surface.
- ⊘  ● Do not place furniture outside . For indoor use only.
- ⊘  ● Stains may be removed with mild soap solution and damp cloth.
- ⊘  ● Children should not climb or jump on the furniture.





- Dust and pick-up spills using a clean, non-colored, lint-free cloth.

Please look in the carton for hardware packs and legs.
Sets often ship in multiple boxes and may arrive a day or two apart.

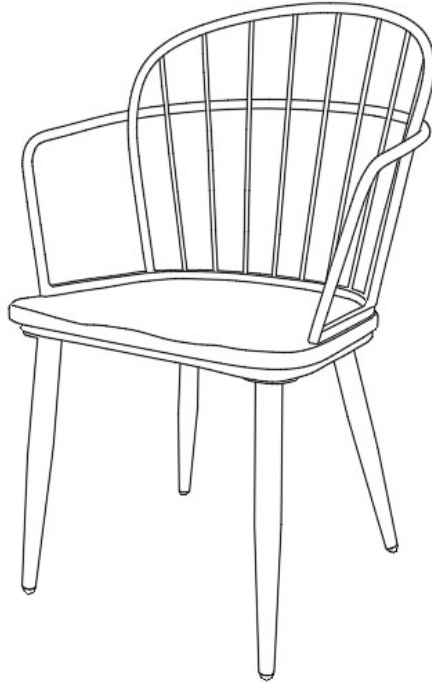
CHAIR

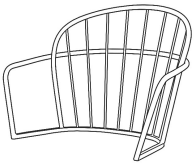

Part List

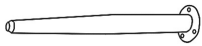
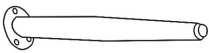
Label	Picture	Description	QTY
A		Chair Back	1
B		Seat Panel	1
C		Front Leg	2
D		Back Leg	2

Hardware List

Label	Picture	Description	QTY
①		Short Bolts (1/4"x16mm)	13
②		Long Bolts (1/4"x50mm)	6
③		Flat Washer	6
④		Allen Wrench	1

Assembly Preparation

Before
Beginning
Assembly:

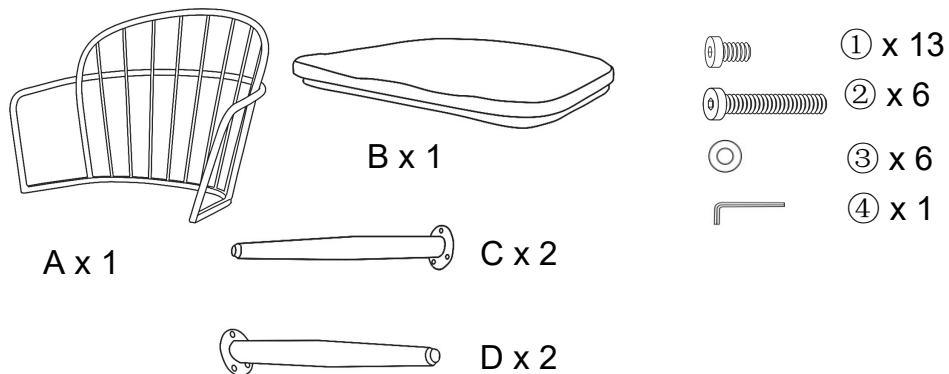

- Read instructions, cover to cover-



- Have 2 adults on hand for assembly-



- Do not assemble on flooring or carpet-



- Assemble on a clean non-marring surface (packing foam)-



- Save all packaging until finished-

Assembly Steps

OVERVIEW

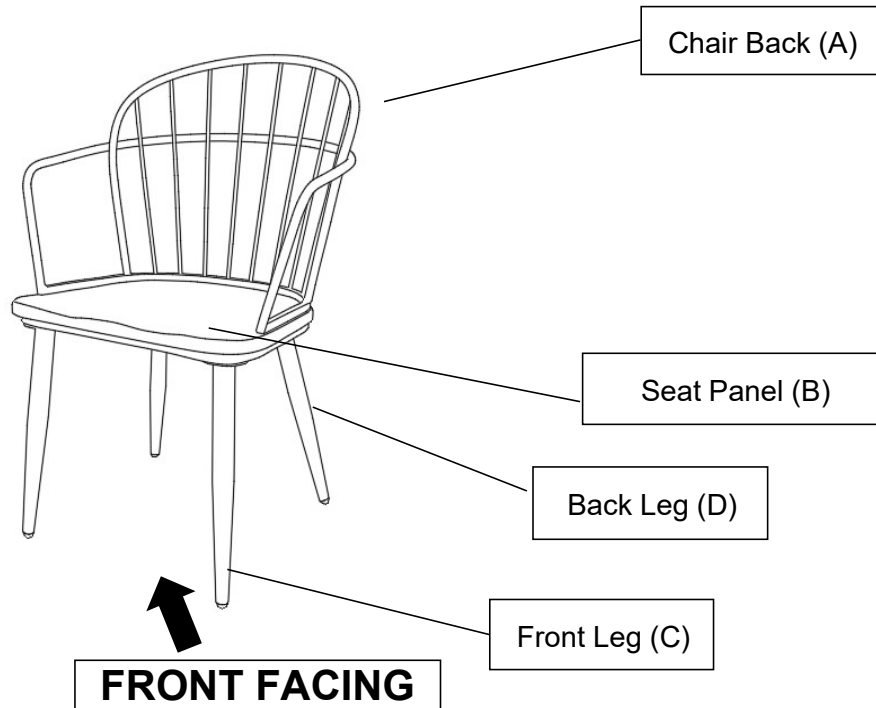

This Chair has multiple parts and may require up to some 30 minutes to assemble. To give you an overview of the Chair parts, the above picture is to help you put the various parts into perspective. Please read through the instructions below to familiarise yourself with the parts and steps before assembly.

Step 1

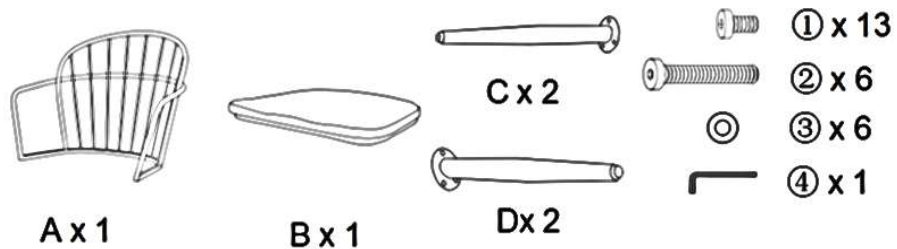

Open the carton and place all the parts onto a clean, non-marring surface.

Step 2

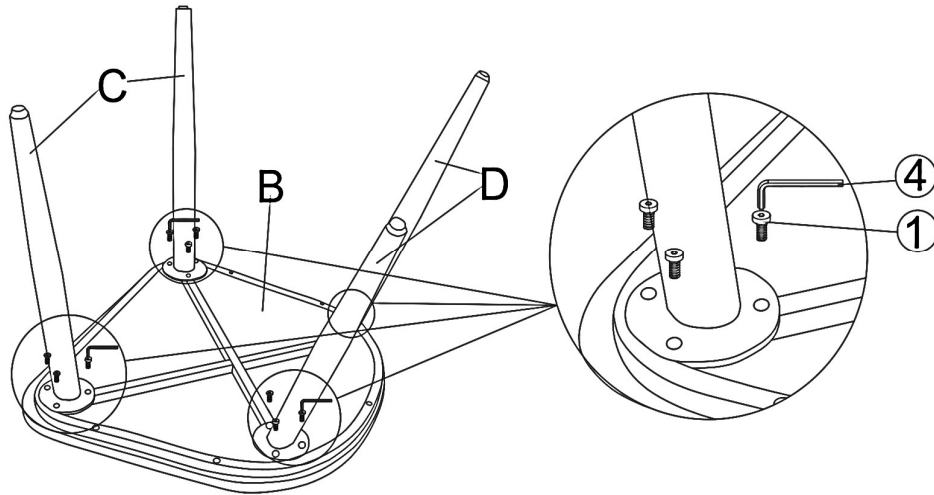

Place the Chair Frame(B) facedown onto a clean, non-marring surface,as shown above.

Align the hole of Front Leg(C) into the Chair Frame(B) ,attach the Front Leg(C) to the Chair Frame(B) using Short Bolt(①) and Allen Wrench(④).

Repeat the same step to install the remaining Back Leg(D).

DO NOT FULLY TIGHTEN BOLTS.

Step 3

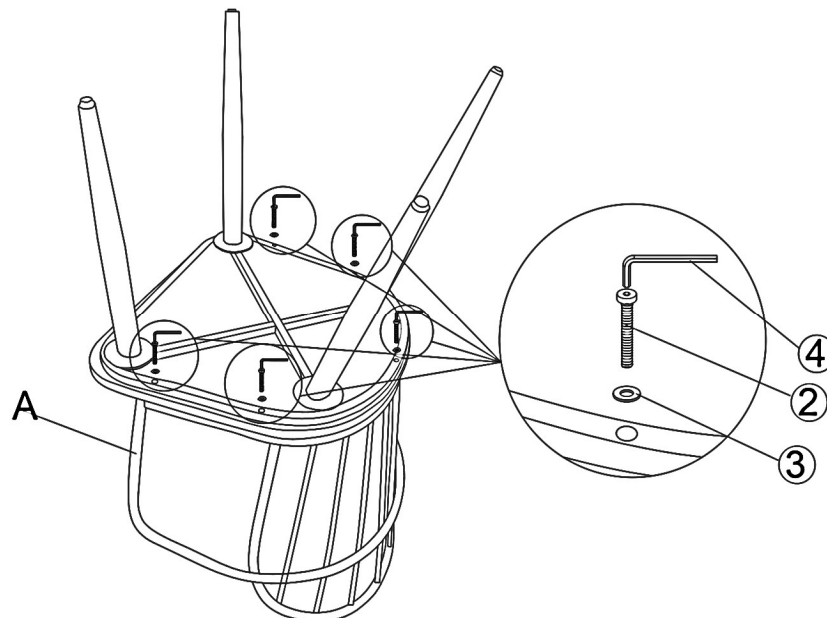

Position the Chair Back(A) facedown onto a clean, non-marring surface,as shown above.

Attach the Chair Frame(B) to the Chair Back(A) using Long Bolt(②), Flat Washer(③) with Allen Wrench(④).

Tighten all bolts at all joints completely.

Step 4

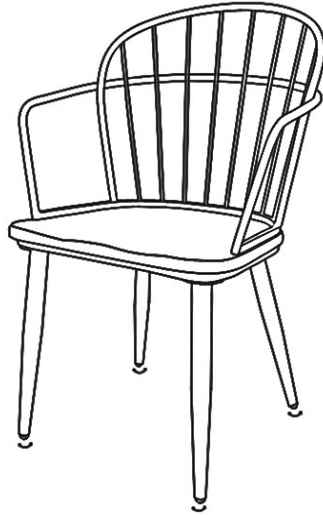

Turn the chair right side up.

Step 5

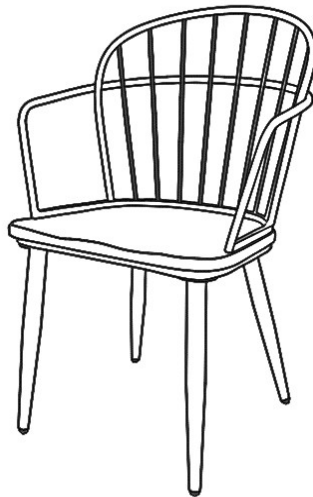

Your chair is ready for use.
This chair can only be used on a flat, level surface.