

Instruction Manual

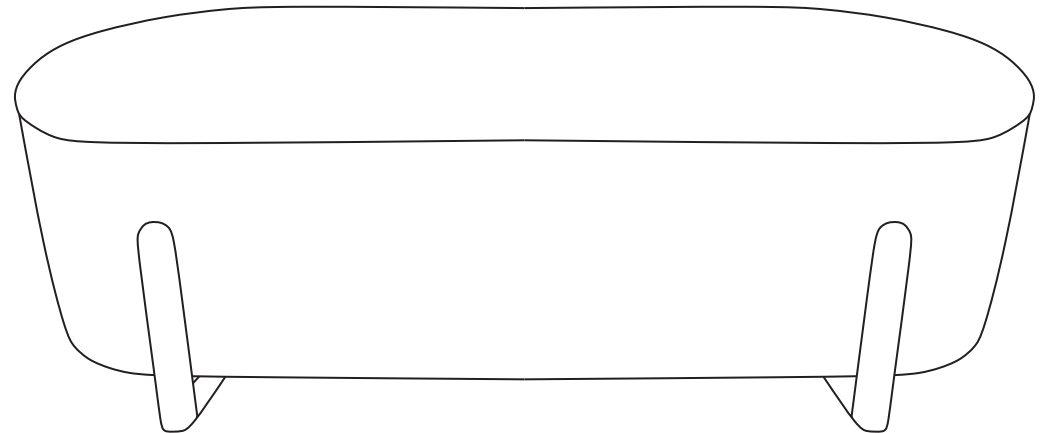



User Guide

Make life better

Warm tips: We are proud of high-quality products and satisfactory service, but the goods may encounter special circumstances during transportation, if you receive the goods with missing or damaged parts, please take photos and contact our customer service before returning the goods , we will customize a solution that satisfies you, thank you.

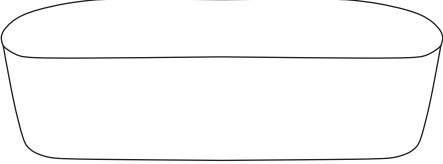
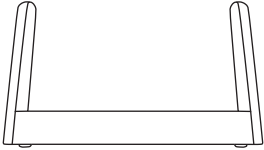
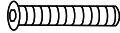

Instruction

NO	DESCRIPTION		QTY
A	Bucket Body		1
B	Leg		2
C	Screw	$\Phi 5/16$ "* 2-3/16"L 	4
D	Flat Washer	$\Phi 5/16$ "*17mm 	4
E	Lock Washer	$\Phi 5/16$ " 	4
F	Allen Wrench	$\Phi 5$ mm 	1

Installation Method

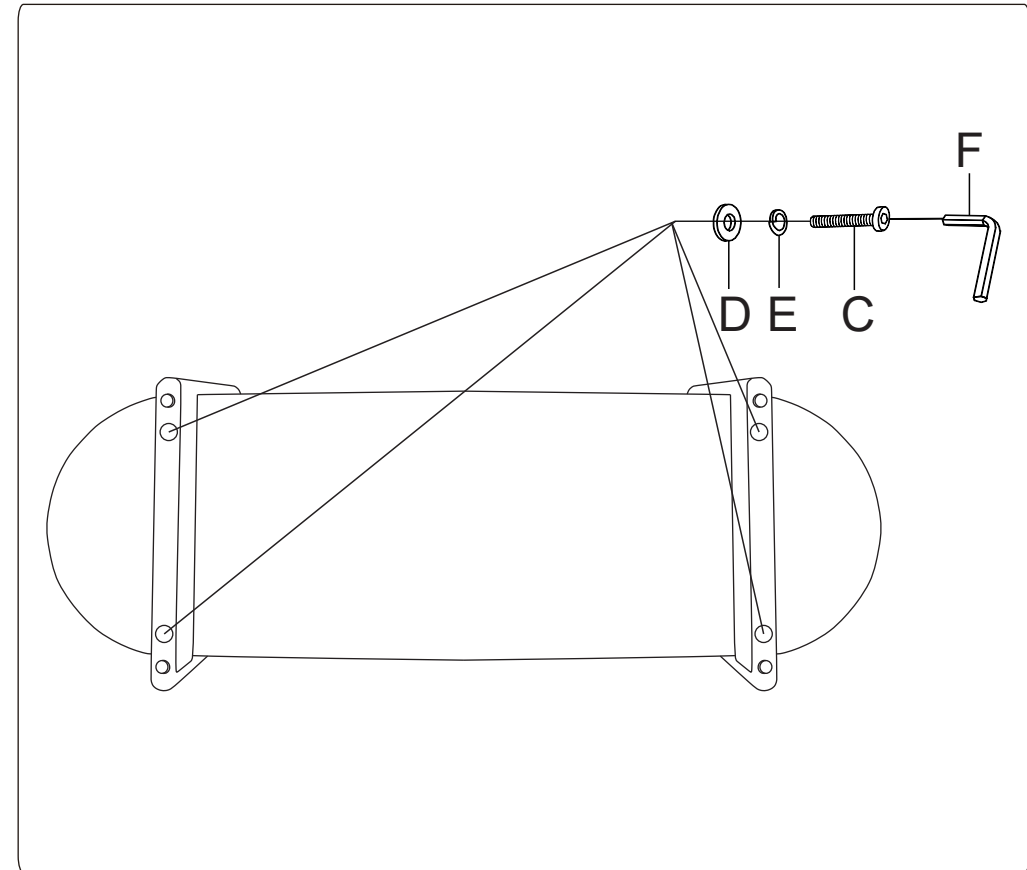

Note:

As shown in the figure, place bucket body A and tighten the four legs with screws.