

INSTALLATION INSTRUCTIONS

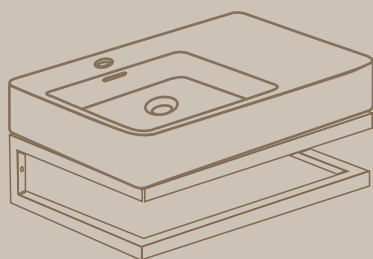

Wall-hung Sink

Wall-hung Sink

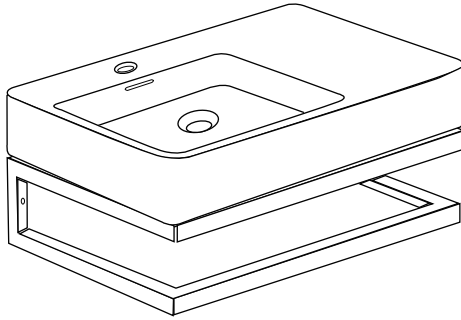

Questions, problems, missing parts?
Before returning to the store, email
Our Customer Service

THANK YOU

Safety Information

Before installing this sink, read this instruction manual carefully. It contains important information concerning the safe installation, operation, and maintenance of your sink. Retain this manual for future use. In the event of sale, transfer, or relocation, ensure this manual remains with the sink.



WARNING: *Keep all packaging materials out of the reach of children to prevent possible choking or suffocation.*



WARNING: *Handle with care. Vitreous chinaware is glass-like with sharp edges if broken. Do not drop, handle roughly, or overtighten bolts.*

Warranty

LIMITED LIFETIME WARRANTY

Our products are manufactured with superior quality standards and workmanship and are backed by our limited lifetime warranty.

Our products are warranted to the original consumer purchaser to be free of defects in materials or workmanship. We will replace FREE OF CHARGE any product or parts that proves defective.

Pre-Installation

Compare all parts with the Hardware Included and Package Contents lists in this manual. Check the surface of the sink for any flaws or damage, including dents, bends, bumps, or scuff marks. If any damage is noticed or parts are missing, do not proceed with the installation. Contact the Customer Service Team.

Packing list

Part	Item	Quantity
A	sink	1
B	setscrew set	1
C	consoles	1

HARDWARE INCLUDED



Hanger bolts



washer



wall anchor



bolts



decorative cap

TOOLS REQUIRED



goggles

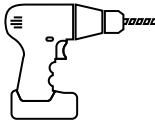

Drill



5/16" diamond drill bit



Tape



Ruler

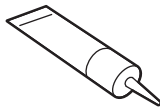

Sealant



Flat Shovel



Phillips screwdriver



Flat screwdriver



Wrench



Pipe Wrench



Expoxy

IMPORTANT: We strongly recommends that this product be installed by a licensed plumber. Ensure that installation complies with applicable plumbing and building codes.

Installation

1 Install Hanger Bolts

Measure the distance between mounting holes in the back of the sink. Drill pilot holes in wood and screw in hanger bolts. Check position with a level.

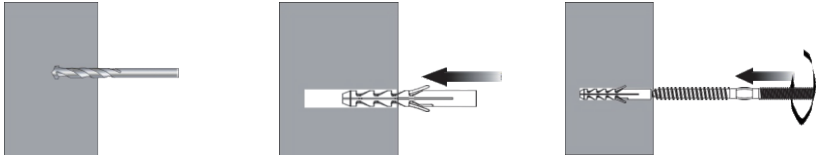

2 Install Wall Anchors

Install wall anchors for console base.

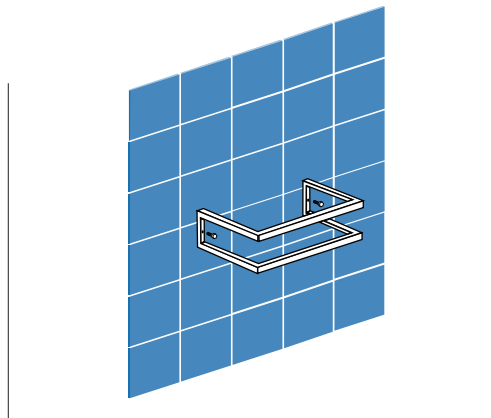

3 Install Basin Bolts

Gently place basin on top of console base and mark the location of the mounting holes on the wall, drill the holes

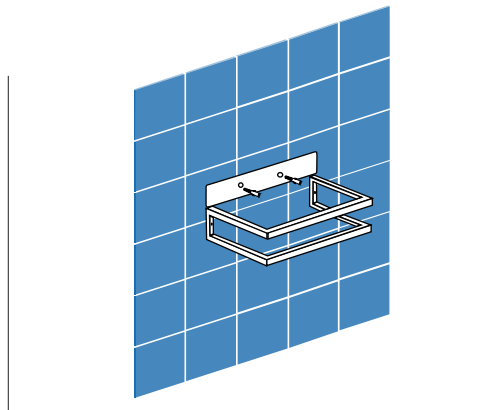

4 Install Sink

Apply sealant to the bottom of the sink and place the sink on top of the console

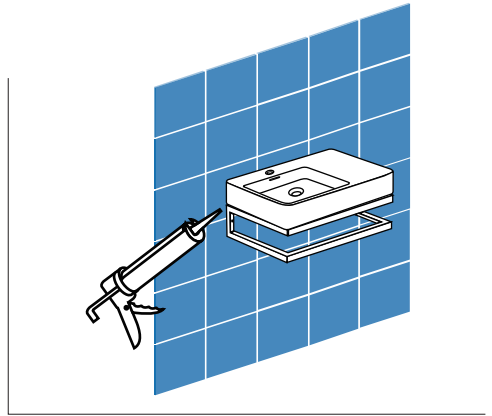

5 Sink Accessories

Complete your installation by adding the preferred plumbing accessories, such as the faucet, click-clack drain, p-trap and angle valves to your sink. Faucet and pop-up drainer not included.

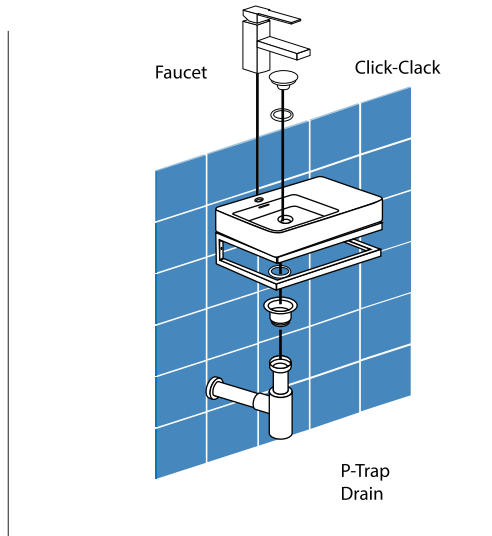

Care and Cleaning

For best results in caring for your sink, we suggest the following:

- Clean the outside surface with mild soap, warm water, and a soft cloth.
- On stubborn stains, use a powdered detergent and damp sponge or nylon scouring pad.
- Never use abrasive scouring powders, cleansers, or pads because they will scratch, damage, and dull the surface.

