

ASSEMBLY INSTRUCTION

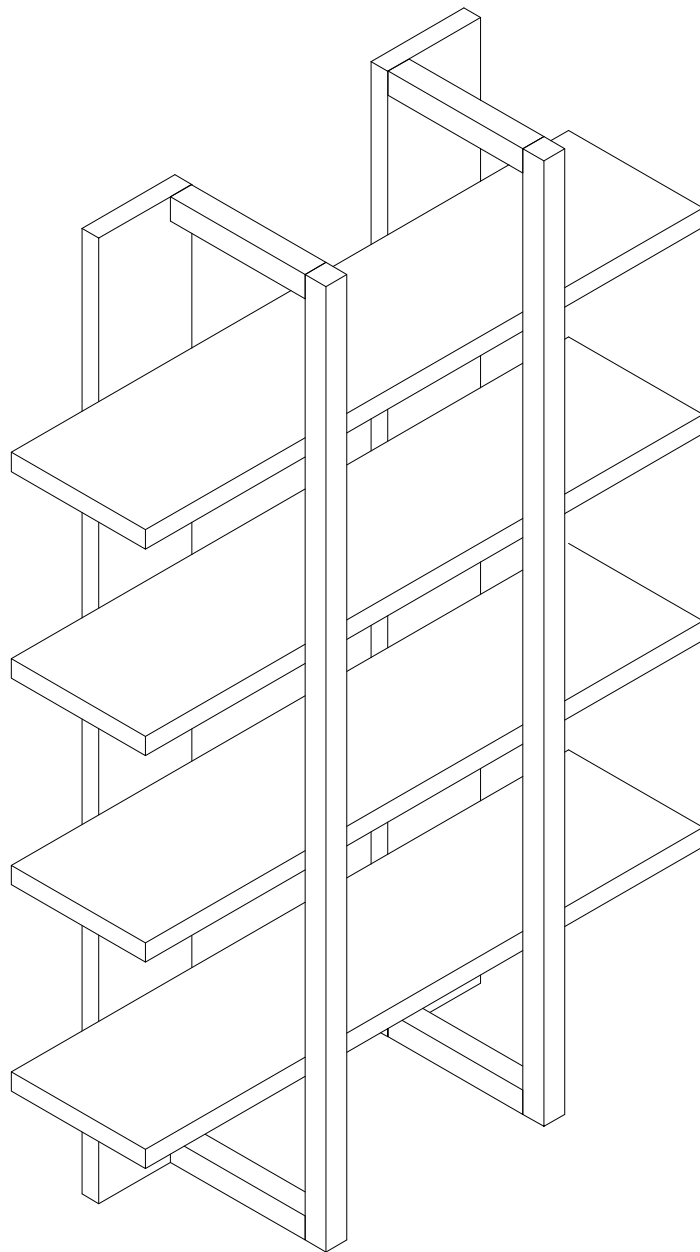

ASSEMBLY INSTRUCTION

PLEASE READ BEFORE ASSEMBLING!

Tip #1: Make sure you've taken all the pieces and hardware out of its packaging before discarding the box.

Tip #2: Using page 2 and/or page 3 of instruction manual make sure all pieces and hardware are accounted for.

Tip #3: Read manual before assembling, it helps!

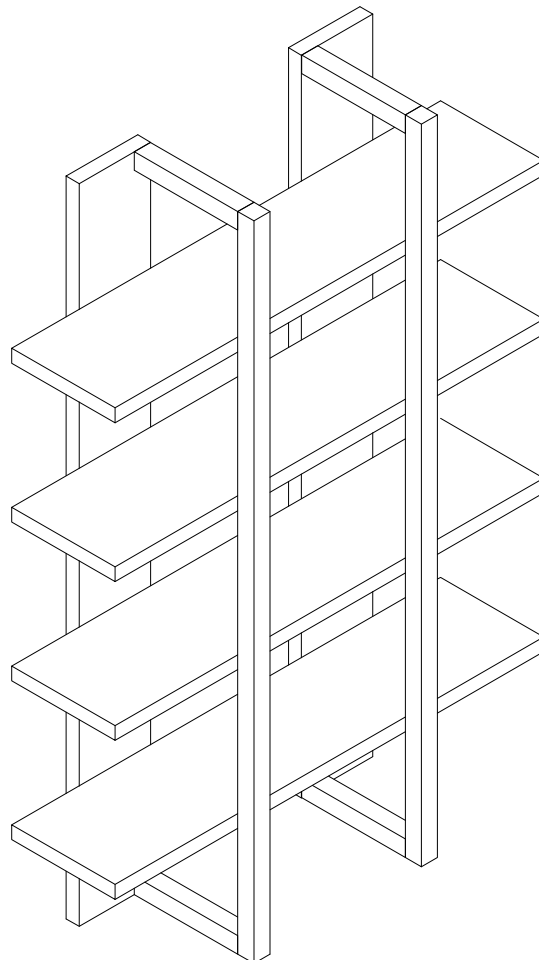



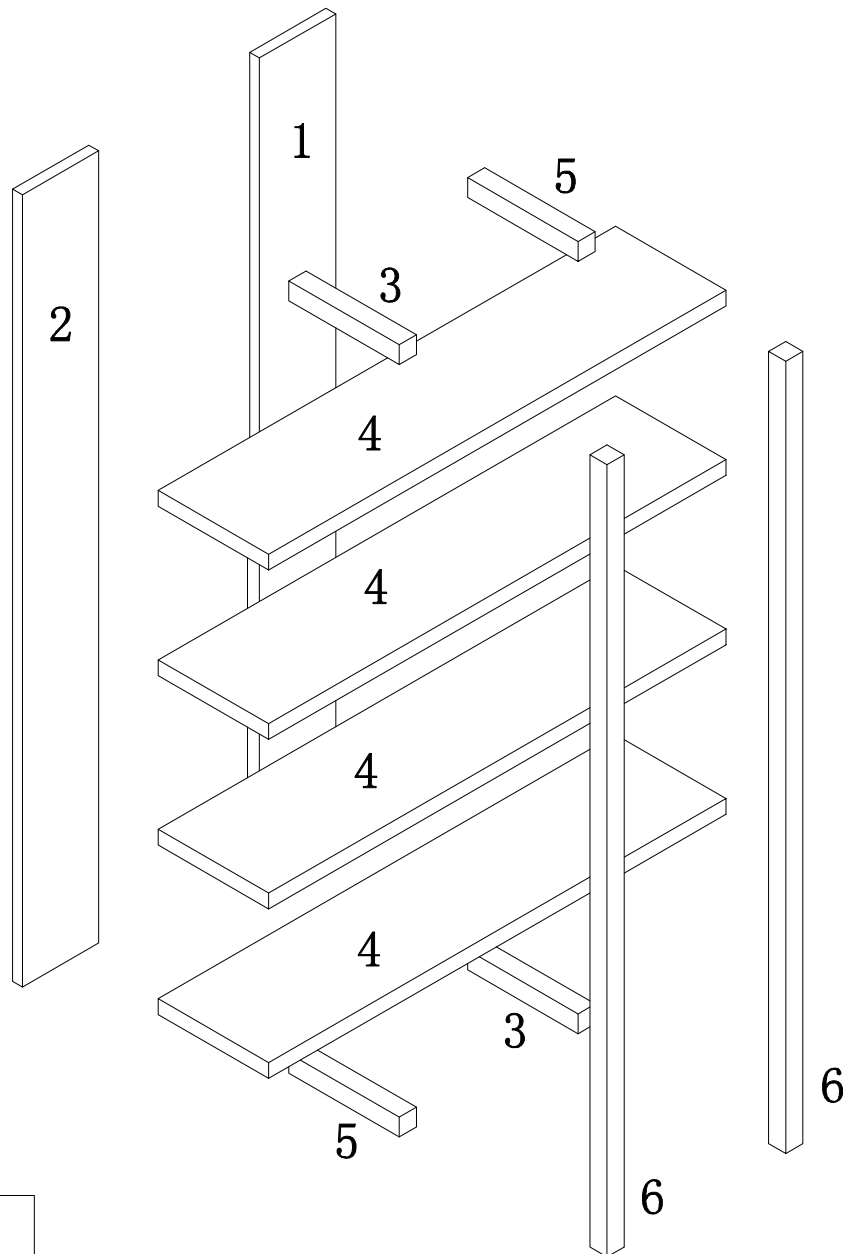



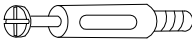

PARTS IDENTIFICATION

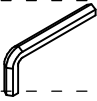

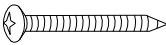
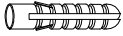
- | | |
|-----|------|
| (1) | 1pc |
| (2) | 1pc |
| (3) | 2pcs |
| (4) | 4pcs |
| (5) | 2pc |
| (6) | 2pc |

HARDWARE IDENTIFICATION

A		ϕ 15	12pcs
B		L29	12pcs
C		ϕ 8x25	24pcs
D		ϕ 7x68	16pcs
E		M4	1pc
F		M6x85	4pcs
G		ϕ 10x15	4pcs
I		ϕ 5 \times 40	2pcs
J		ϕ 8 \times 40	2pcs
K		ϕ 4 \times 25	2pcs
L		40 \times 20 \times 15	2pcs
M		Glue: For securing please apply to wood dowel first before inserting into panel	1pc

ASSEMBLY INSTRUCTION

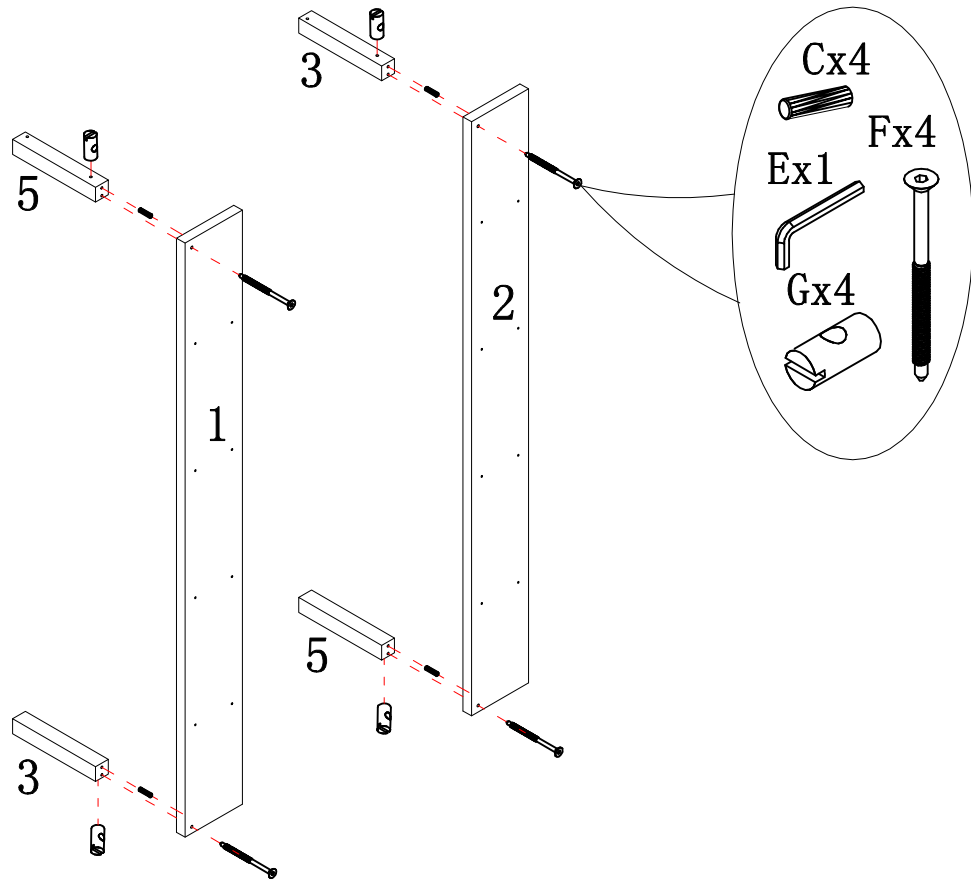

STEP 2

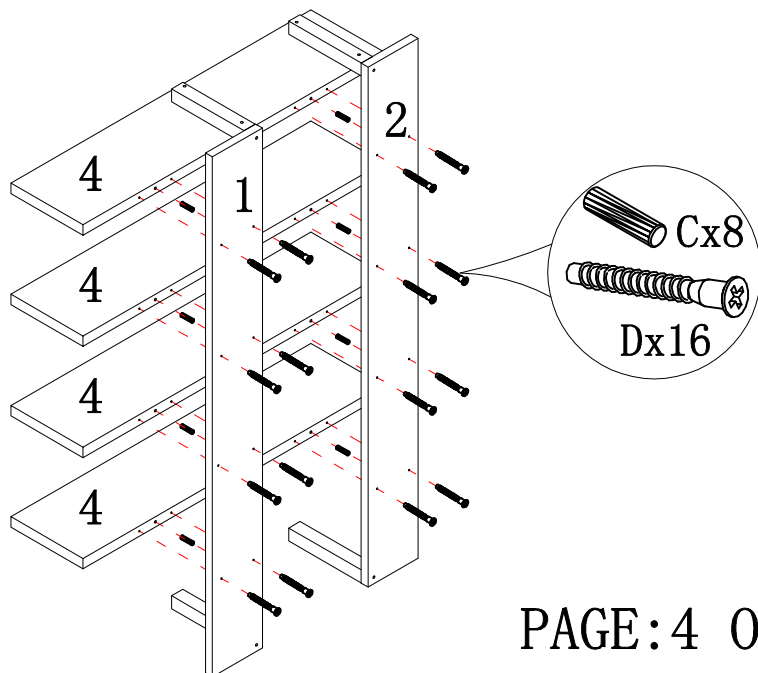

ASSEMBLY INSTRUCTION

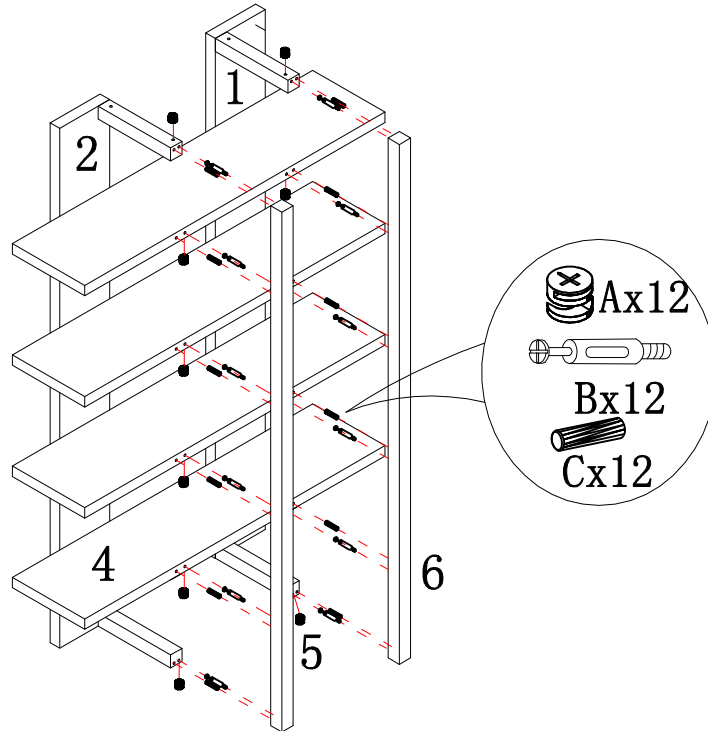

STEP3

STEP4

