

Privacy Screen Fence Panel---Hardware Pack for PSL11 Concrete or other Hard Floor

ASSEMBLY PARTS:

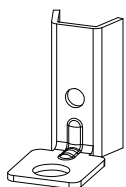

G (x4)



#2 (x4)



#3 (x4)

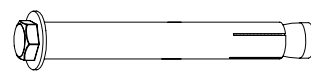

Sleeve Anchors (x4)

①

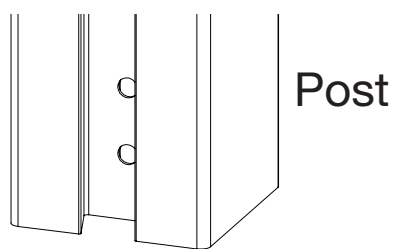
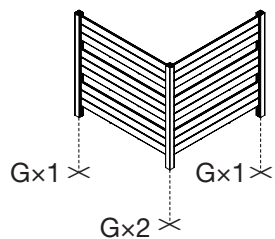

Post

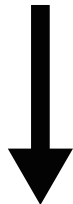
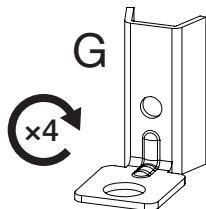

②

G

Post

#3

#2



③

G

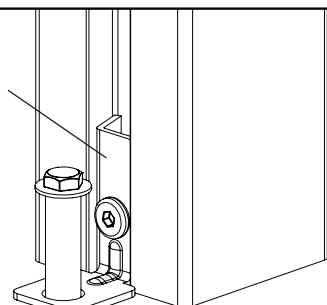

Sleeve Anchors

④

