





ASSEMBLY INSTRUCTION FOR DINING TABLE

Step 1

Hardware List

A		Bolt	8x70mm	8
B		Bolt	8x45mm	8
C		Socket wrench		1
D		Self-Adhesive Furniture Pads		4

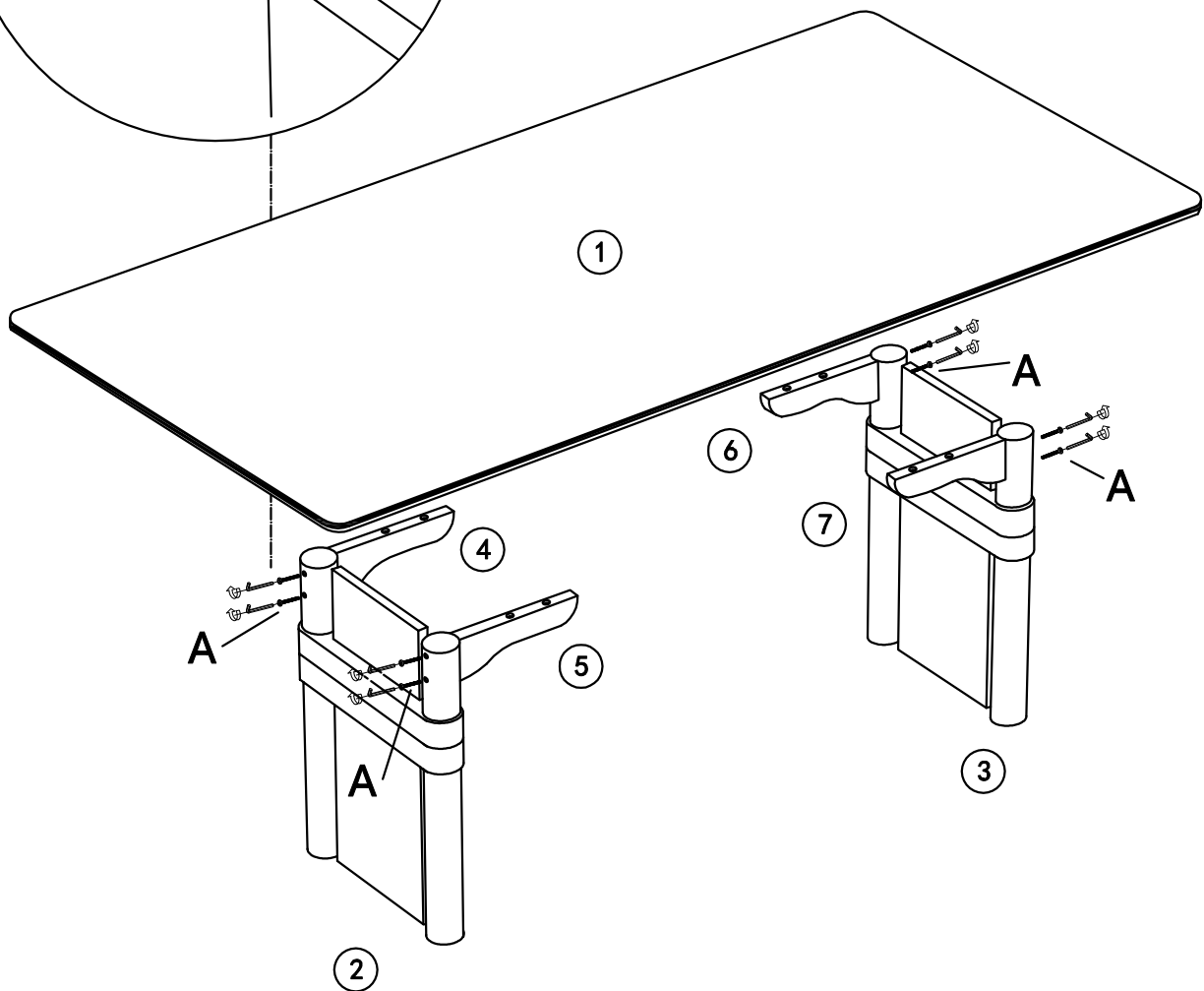
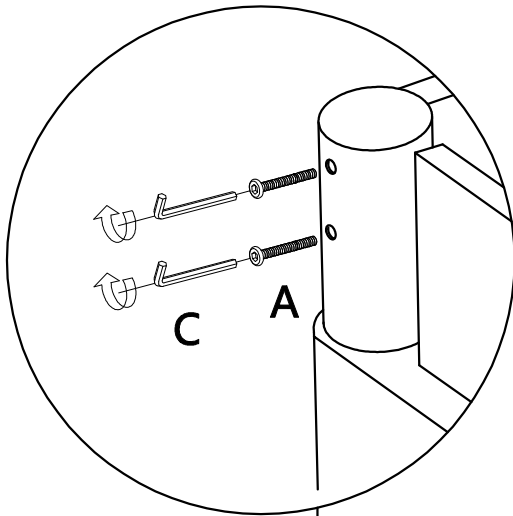

Step 2

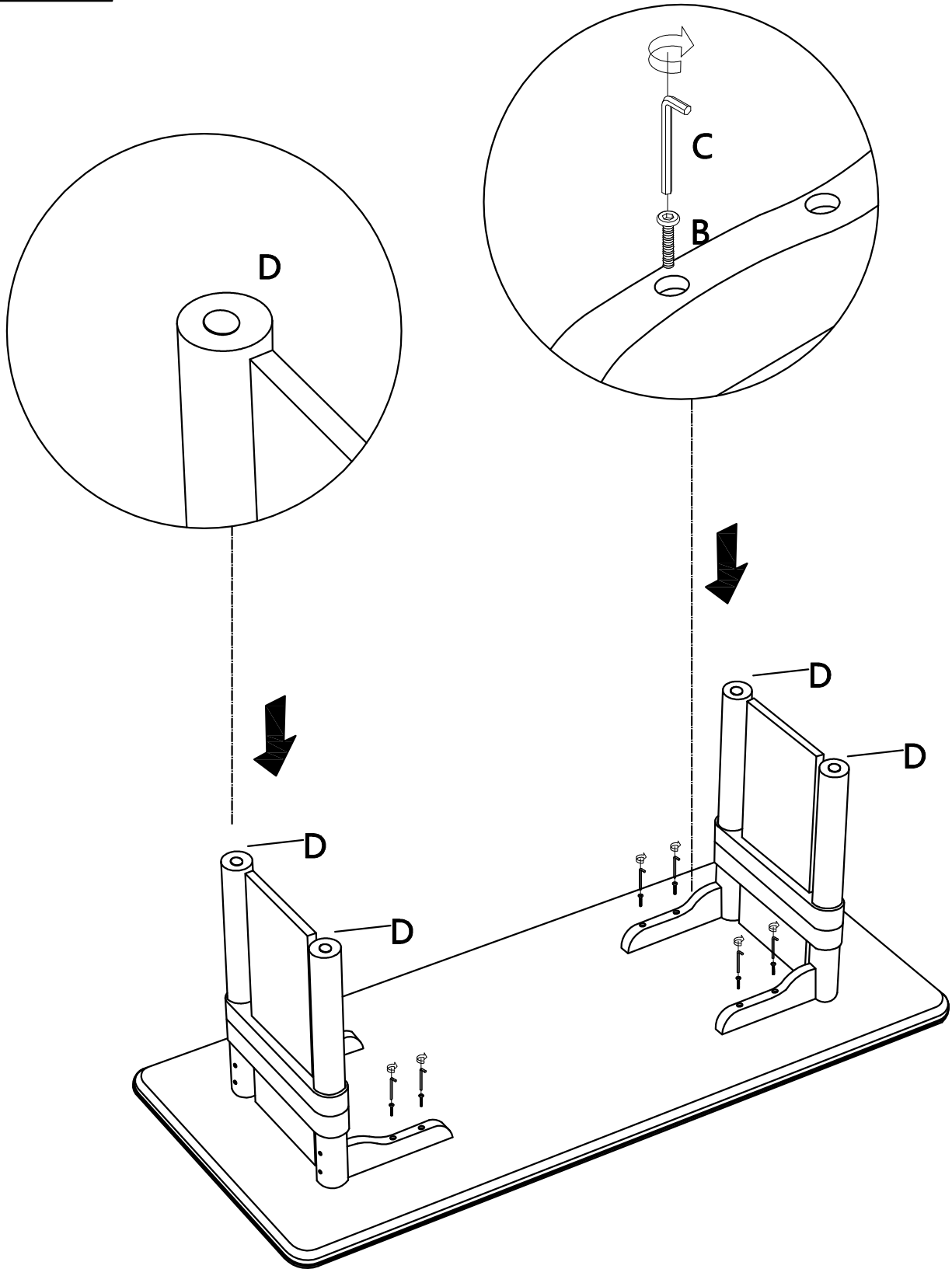

Step 3

Adjusting floor levelers.

Your furniture has been expertly crafted and re-adjusted by professionals. However, slight shifts can occur during transportation. If you notice that the furniture wobbles, a quick adjustment can help ensure stability and a seamless look.

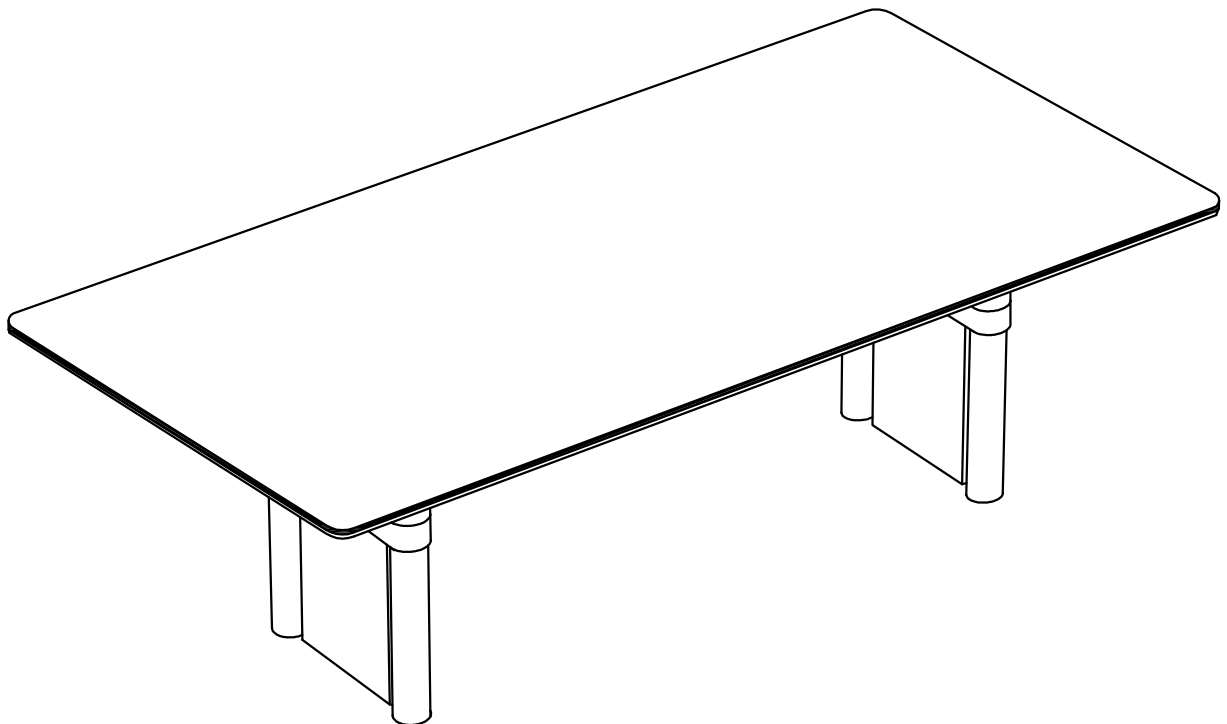

Adjusting Floor Levelers

Check for stability - Place the furniture in its final position on a level surface. If it wobbles or doesn't sit evenly, the floor levelers need adjusting.

Locate the levelers - These are small adjustable feet found at the bottom corners of your furniture.

Adjust as needed - Using your hand or a wrench, turn the levelers clockwise to raise or counterclockwise to lower the furniture. Make small adjustments and check stability after each turn.

If you need further adjustments, repeat the process in small increments.