

## WARNING

- \*\* WE RECOMMEND INSTALLATION OF THIS LIGHTING FIXTURE BE DONE BY A LICENSED ELECTRICIAN \*\*
- \* Switch off the main electrical supply from the main fuse box / circuit.
- \* Breaker before installation.
- \* Inspect item carefully before attempting to install.
- \* If there is any damages or obvious defects, do not install.
- \* Item may not be returned once it has been installed.











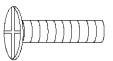

## CARE AND MAINTENANCE

- \* To clean the outside of the fixture, use a dry or slightly dampened clean cloth (use clean water, never a solvent) to wipe the surface of the fixture.
- \* To clean the inside of the fixture, first disconnect power to the fixture by turning off the circuit breaker or by removing the fuse at the fuse box. Next, use a dry or slightly dampened clean cloth (use clean water, never a solvent) to wipe the interior surface of the fixture.
- \* Do not use any cleaners with chemical, solvents or harsh abrasives. Use only a dry soft cloth to dust or wipe carefully.

## NOTICE& IMPORTANT SAFETY INSTRUCTIONS

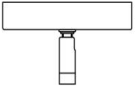
- \* Please make sure that you have all parts indicated before you begin assembly of this item
- \* This item should be assembled on a soft surface to prevent scratching the finish during assembly
- \* To reduce the risk of fire, electrical shock or injury to persons or property, please follow the guideline below for safe use and installation
- \*The external flexible cable or cord of this lamp cannot be replaced  
If the cord is damaged, the lamp shall be destroyed

### Part List and Hardware List

PIECE	DESCRIPTION	PICTURE	QUANTITY	PIECE	DESCRIPTION	PICTURE	QUANTITY
A	Wire Nut		3X	G	short tube		1X
B	Mounting Screw		2X	H	Twine tube		1X
C	Mounting Plate		1X	I	long tube		2X
D	Bulb		1X	J	Socket Assembly		1X
E	Canopy		1X	K	shade		1X
F	Canopy Nut		2X	L	Socket Ring		1X

9"W18.5"-48.5"H

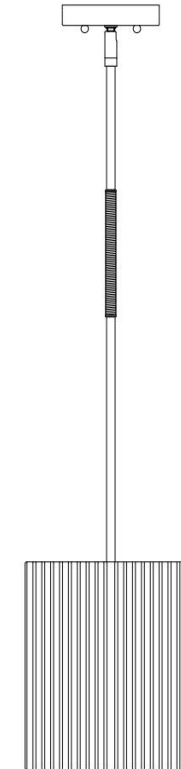

## PREPARATION

- \* Before beginning assembly of product, make sure all parts are present. Compare parts with package contents list and hardware contents list.
- \* If any part is missing or damaged, do not attempt to assemble the product.
- \* Estimated Assembly Time: 30 minutes.
- \* If you are having difficulty, our friendly Customer Care team is always here to help.

**NOTE: PLEASE USE TYPE "A" BULB MAX 60-WATT OR LED BULB MAX 9-WATT, THERE IS 1PC LED 4-WATT BULB IN THE BOX**

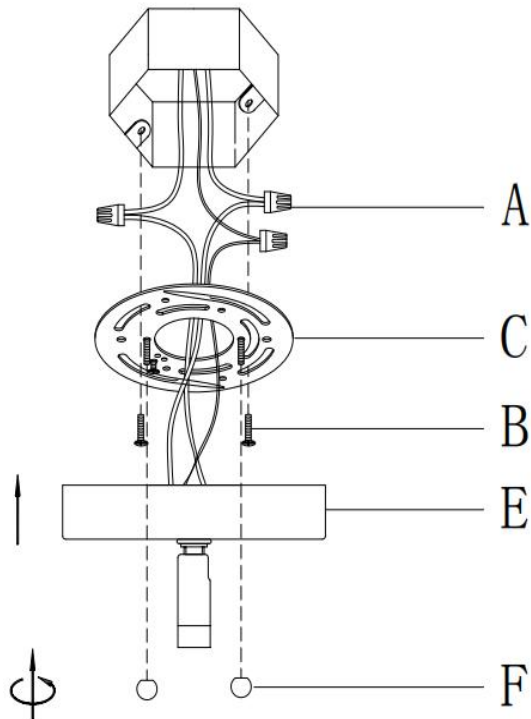

**Step 1: Unpack all parts from cartons carefully.**

**Separate the Mounting Plate(C) from the Canopy(E) by turning the Canopy Nut (F) anti-clockwise.**

**Install the Mounting Plate(C) to the junction box with Mounting Screw (B).**

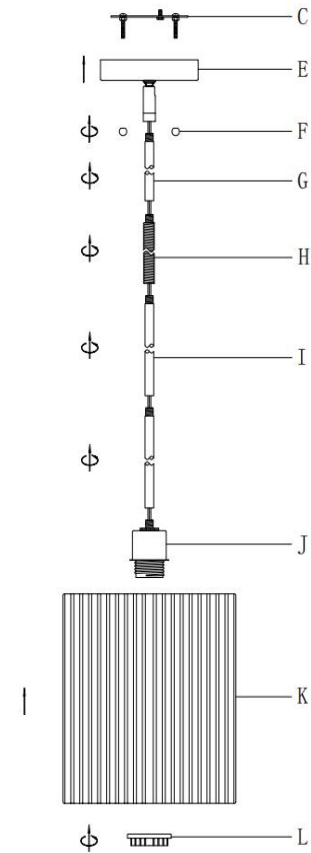

**Step 2: Insert the fixture wire through the long tubes(I)Twine tube(H)short tube (G)in turn to get desired length to Canopy(E).then Rotate each part clockwise till tight.**

**Separate the Socket Ring (L) from the Socket (J)anti-clockwise, Put the shade (K) onto the Socket (J) by turning the Socket Ring (L) clockwise.**

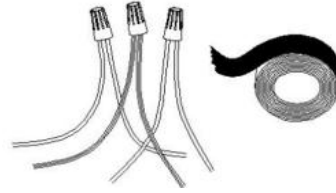
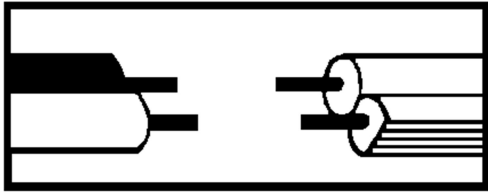

**Step 3: Wire connection**

Connect fixture neutral wire (ribbed) to the outlet box neutral wire (usually white) using a wire nut.  
 Connect fixture hot wire (smooth with markings) to the outlet box hot wire (usually black) using a wire nut.  
 CAUTION: Do not reverse the hot and neutral connections

**Grounding Instructions:**

Wrap ground wire from outlet box around green ground screw on mounting bracket, no less than 2" from wire end. Tighten ground screw. If fixture is supplied with a ground wire, connect to outlet ground wire with a wire nut

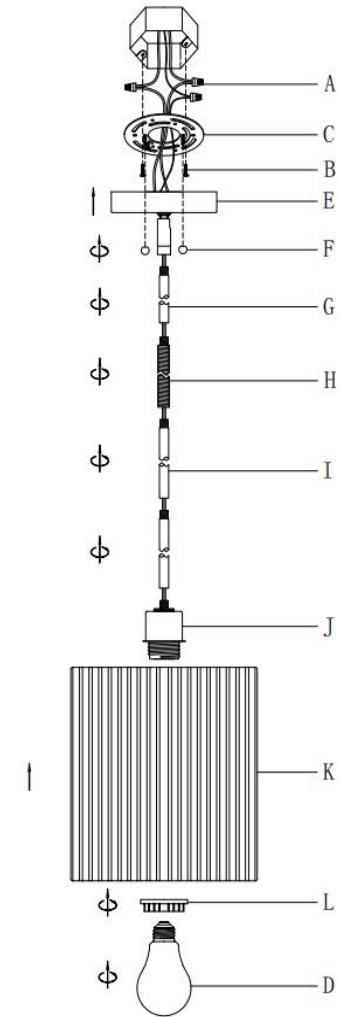

**Step 4: Attach the Canopy(E) to the junction box and fix it by turning the Canopy Nut(F) clockwise. Insert the bulbs (D) into the Sockets.**