

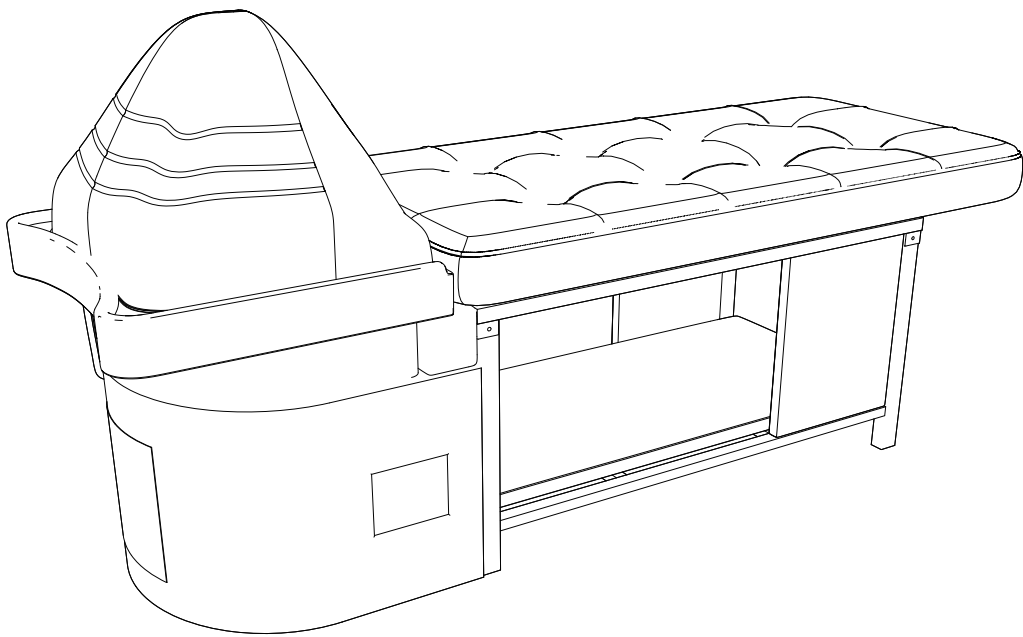

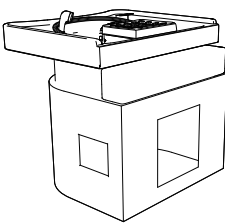

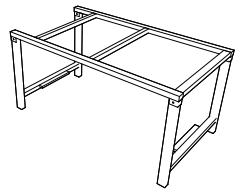

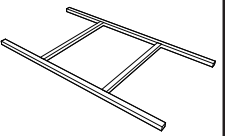

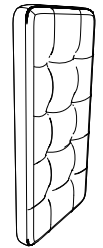
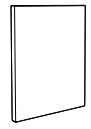
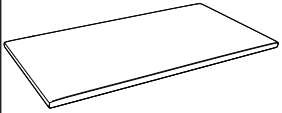
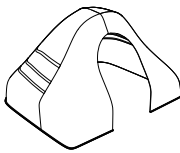
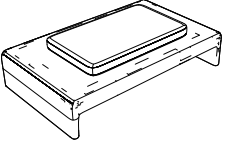
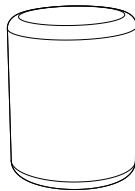



Installation Instructions

Parts Included



A*1 	B*2 	C*1 	D*1 								
E*2 	F*1 	G*1 	H*1 								
I*1 	<table border="1"><tr><td></td><td></td><td>*8 </td><td>*14 </td></tr><tr><td colspan="2">Wrench</td><td colspan="2">Screws</td></tr></table>					*8 	*14 	Wrench		Screws	
		*8 	*14 								
Wrench		Screws									

① Unfold the frame

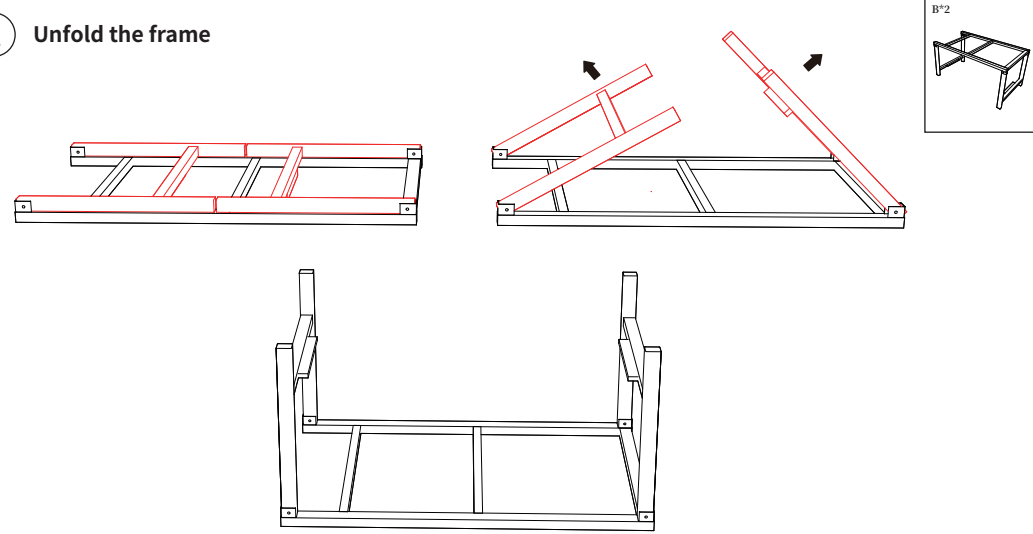

2 Install the brackets

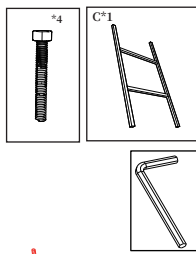
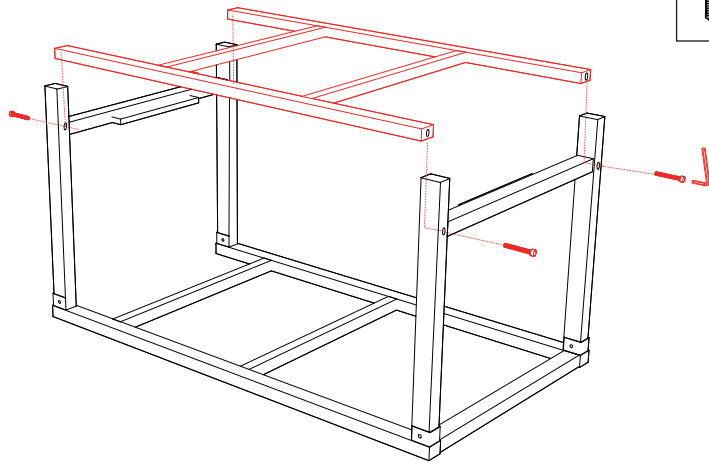

2-1. Align the screw holes of the frame and the brackets respectively, and insert the screws.

Please make sure all the screw holes are aligned before tightening all the screws.

3 Install the side panels

- 3-1. Place the side panel on the bed frame, align the screw holes and insert 4 screws.
- 3-2. Do not tighten the screws yet.
- 3-3. Stand the bed frame up and insert another 4 screws on the other side.
- 3-3. Tighten all 8 screws.

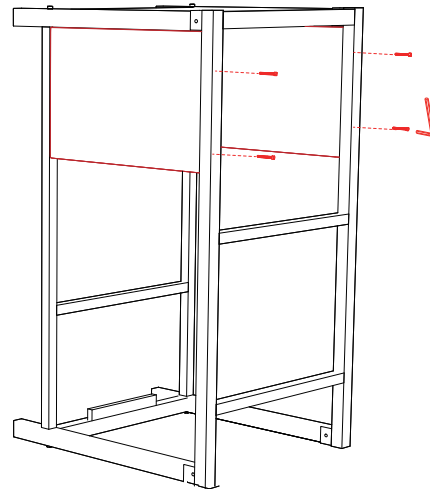
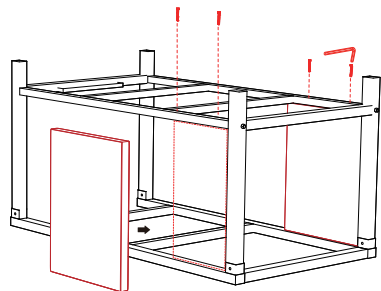
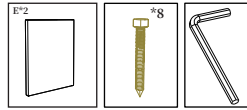

4 Connect the shampoo basin and the bed frame

4-1. Align the four screw holes on the shampoo basin and the bed frame, and insert the screws.

4-2. Please make sure all four screw holes are aligned before tightening the screws.

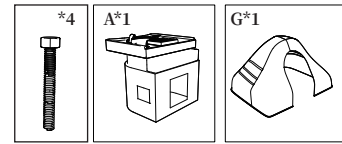
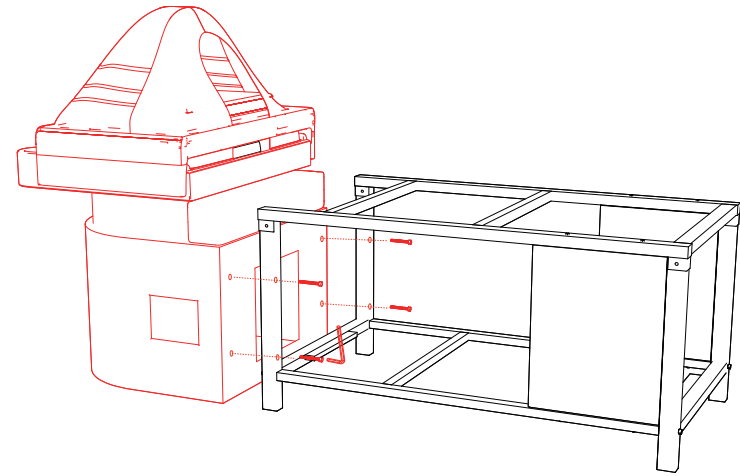

5 Install the mattress

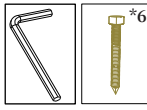
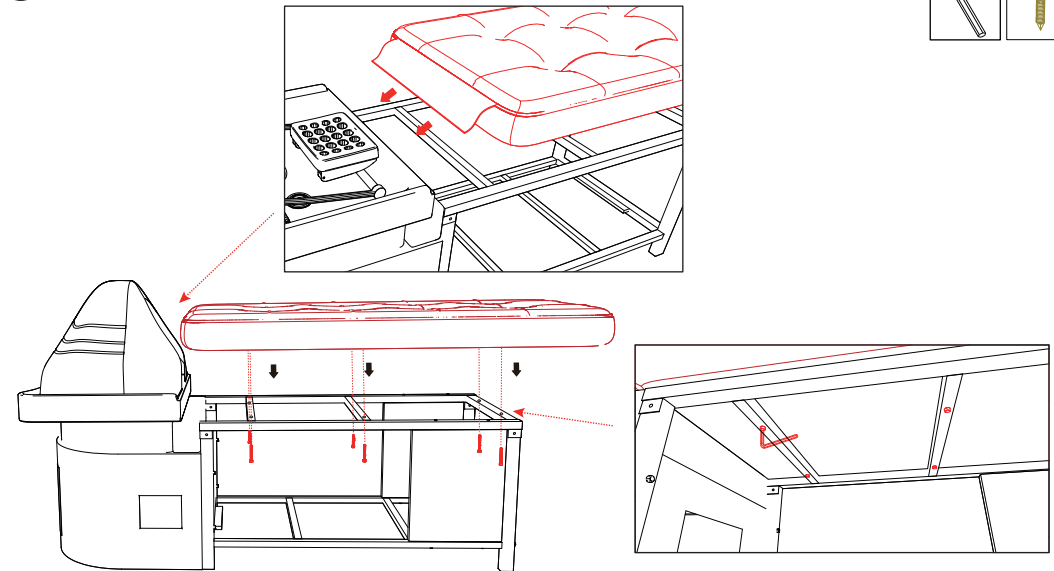

5-1. Place the mattress on the bed frame, with the leather side of the mattress facing the side closer to the shampoo basin.

5-2. Insert six self-tapping screws through the screw holes of the bottom bed frame respectively, and then tighten them.

6 Place the partition

6-1. Insert the partition from the tail of the bed frame. After aligning it with the bed frame, press down firmly.

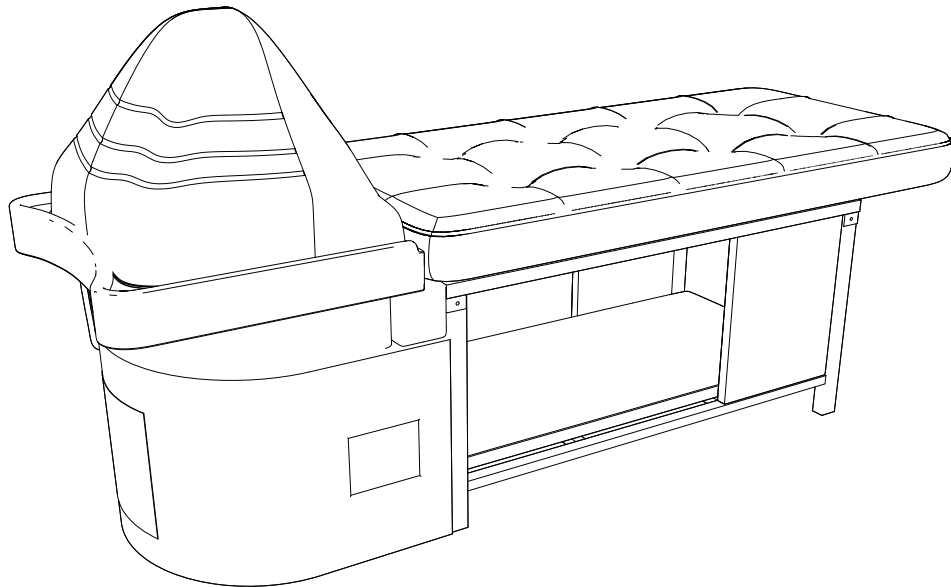
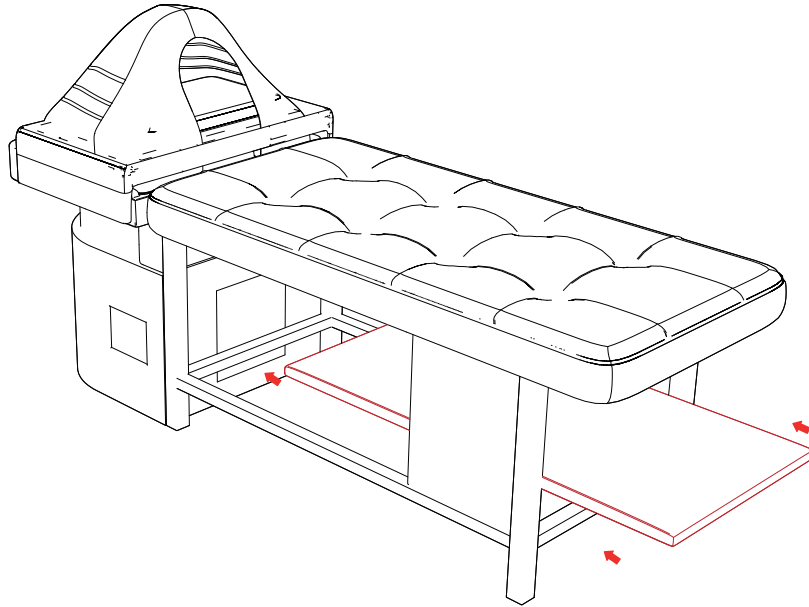

FUNCTION DESCRIPTION

The temperature is adjustable with 10 levels. You can adjust the water temperature within the range of 35°C - 45°C.

Steps:

1. Please cover the drain outlet first.
2. Open the black rubber stopper of the water inlet. The water inlet is equipped with a filter screen, and you can clean the debris regularly.
3. Add water to the shampoo basin. The water will enter through the water inlet.
4. Turn on "Head Therapy". The water will enter through the water inlet, flow out from the U-shaped pipe, and then circulate.



Head therapy

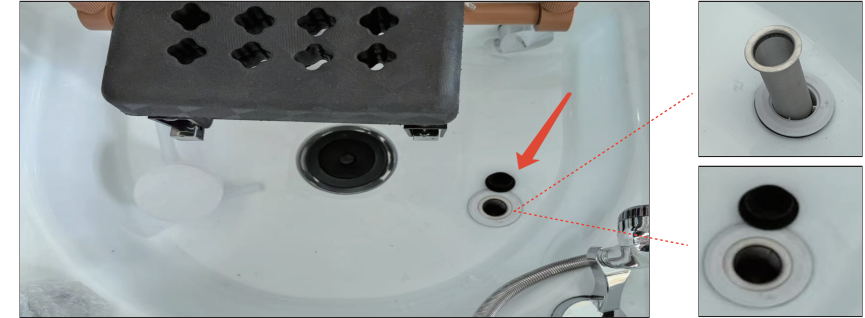

Steam

1. Add enough water to the shampoo basin, almost covering the white box.
2. Click "Steam" and wait for a while. Steam will come out of the white box.

The temperature is adjustable with six levels. The higher the level, the higher the temperature of the steam.



Phototherapy

Each time you click the button, you can turn on, turn off the light or adjust its color.



Time

This is used to adjust the time for fumigation and scalp treatment. After clicking the "Time" button, use the "Temp+" / "Temp-" buttons to increase or decrease the set time.

Chair Operation Guide

1-1. Below the water valve, there are two water pipes. One pipe can connect to the hot water outlet, and the other can connect to the cold water outlet (choose either one, no need to distinguish).
1-2. Adjust cold or hot water by rotating the valve left or right.

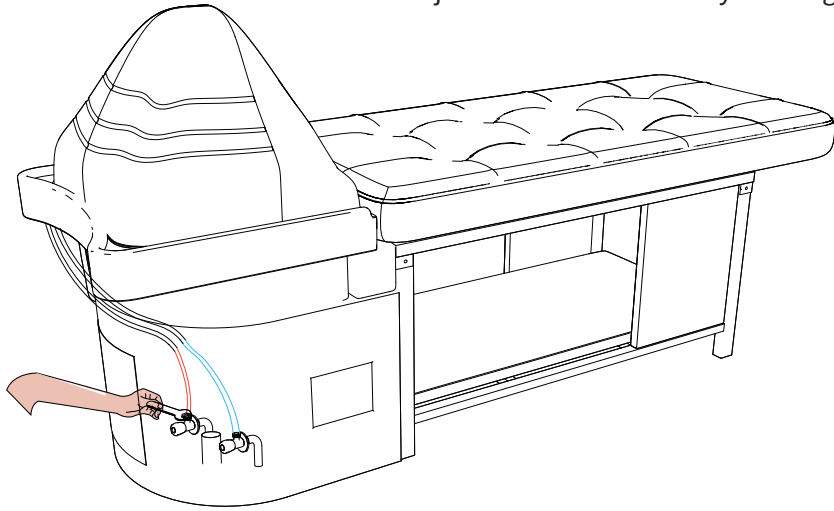

Steps for Applying Teflon Tape to Pipe Threads:

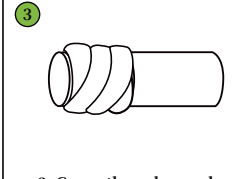
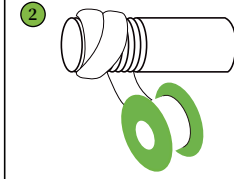
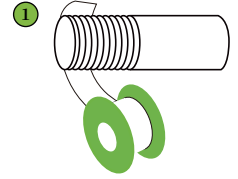

1-2. Wrap tape from the thread edge inward, keeping it flat and tight.

3. Cover threads evenly with 2-3 wraps, slightly thicker at the edge.

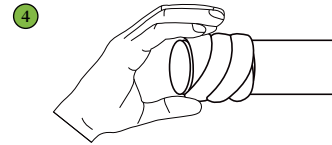

4. Press tape firmly onto threads.

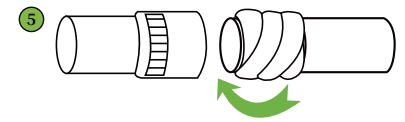

5. Screw fitting clockwise until secure.

2. Drainage

Drainage can be conducted through the internal drainage pipe of the shampoo chair.

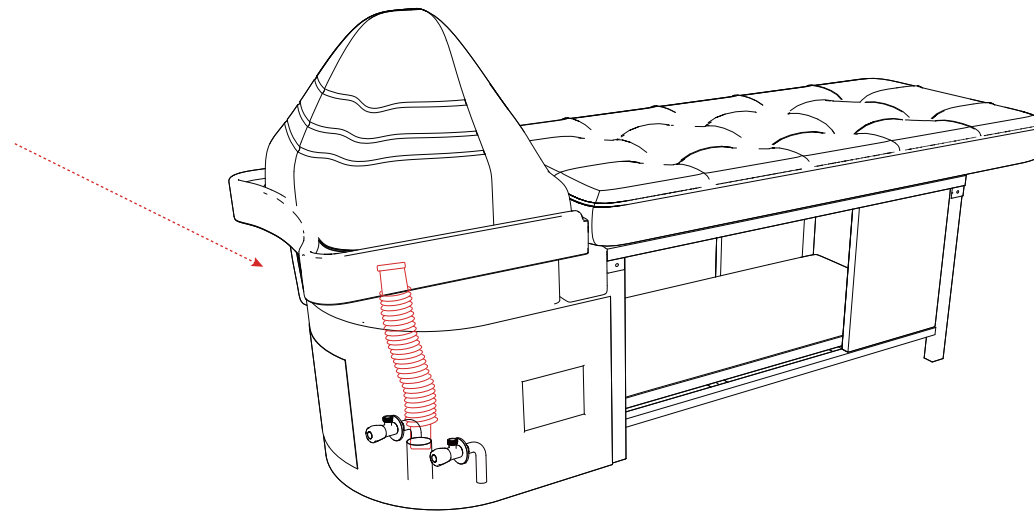
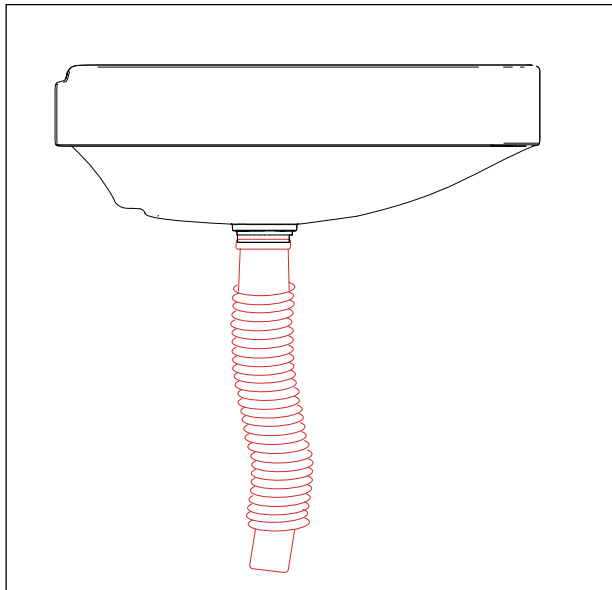

Trouble and Solution

NO.	Trouble	Potential Issues	Solution
1	Missing screws.	Some screws are pre-installed.	Most screws are pre-installed on the chair's components. Please check again to see if there are screws in the screw holes on the chair's components.
2	Missing parts.	The chair is shipped in two packages.	If your chair is shipped in two separate packages, we will send you the tracking numbers for both packages via Amazon after the chair has been shipped. Please keep an eye out for them. The two packages may not arrive simultaneously.
3	Damaged	The chair leather, metal, and other accessories are damaged.	If you find any damage to the chair after receiving it, please do not rush to return it. Please contact us and provide pictures of the damage in your message so that we can quickly identify the required parts. We will promptly send you the replacement parts.
4	Other issues	Contact Us	In order for us to better understand and resolve the issue quickly, please provide relevant pictures or videos related to the problem in your email.

WARNING:

ANY PACKING BAGS OF THIS PRODUCT ARE NOT TOYS. TO AVOID THE DANGER OF SUFFOCATION, KEEP AWAY FROM BABIES AND CHILDREN. DO NOT USE IN CRIBS OR BEDS.