

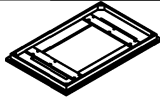







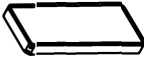

# ASSEMBLY INSTRUCTION

**DIMENSINONS : 66"L x 42"W x 30"H**

**Description :  
TABLE**

No	LIST OF PAST	Q'TY
1	TABLE TOP 	1pc
2	TABLE LEG 	4PCS
3	TABLE BASE 	1PC
4	MOUNTING PLAT 	2PCS
5	GLASSES 	2PCS

No	LIST OF HARDWARE	Q'TY
A	LONG BOLT 	Ø5/16" x 63.5mm 8PCS
B	BOLT 	Ø5/16" x 38mm 20PCS
C	LOCK WASHER 	Ø5/16" x D10 x 1.1mm 28PCS
D	WASHER 	Ø5/16" x D22 x 2mm 28PCS
E	ALLEN KEY 	58 x 4mm 1pc

## STEP 1

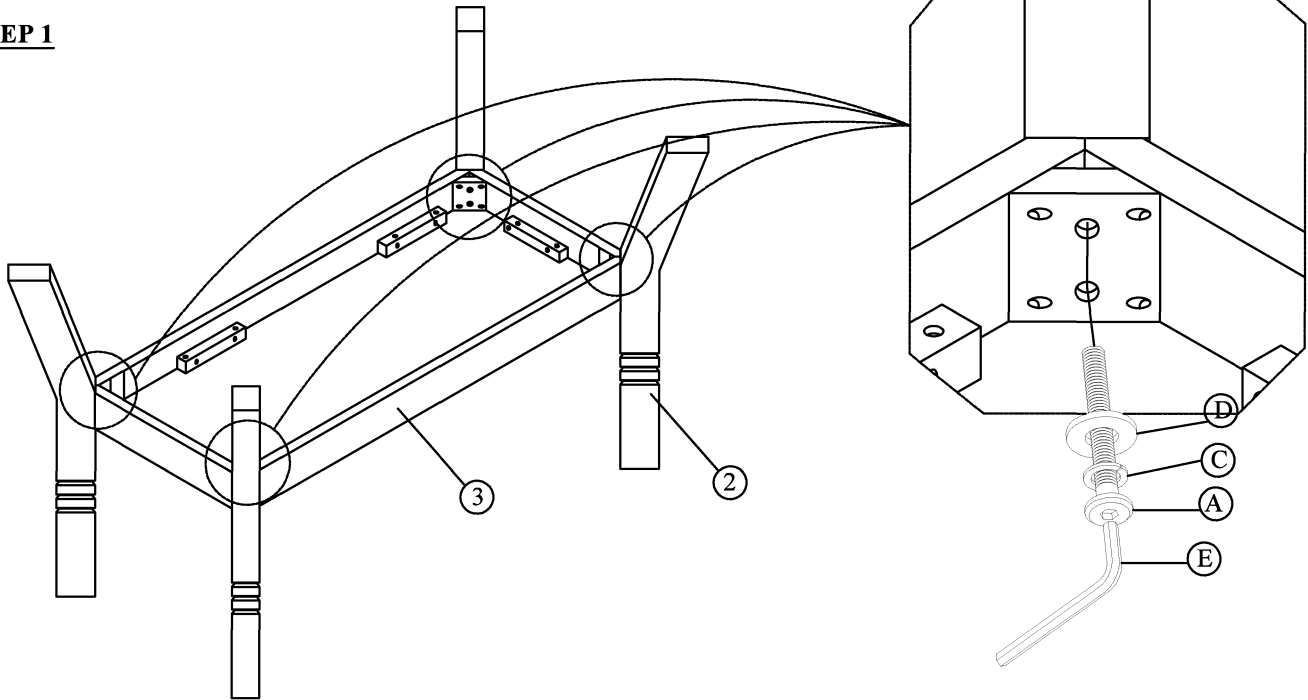

## STEP 3

