

2152 - Aquila Major

constellation™

assembly instructions

SONNEMAN®
A WAY OF LIGHT

Constellation™ Product Information and Warnings

Important

- **Always disconnect the power before installing or replacing Luminaires and before cleaning or other maintenance.**
- **Consult a qualified, licensed electrician to ensure correct branch circuit conductor.**
Consulter un électricien qualifié pour vous assurer que les conducteurs de la dérivation sont adéquats.
- Please read all included assembly instructions and warnings carefully before installation. Contact Customer Service if you have any questions or concerns. Before installation, please confirm that the fixture is compatible with your supply voltage and dimming system, if present.
- LEDs are highly sensitive electronic devices, and must be treated with care. Do not open any factory sealed compartments, and avoid touching the LEDs with your hands or any object.
- Although all our fixtures are equipped with protective devices, LED electronic systems are vulnerable to power surges and supply variations. Do not install LED fixtures on the same circuit as any motors, appliances, or HVAC systems.
- Remote LED Driver installation must be done by a licensed electrician and in accordance with local building and electrical codes. Remote installations should be in an accessible location, as close to the fixture as possible. The appropriate wire gauge must be used to limit the voltage drop to avoid overloading the LED Driver.
- Any mounting hardware is provided for your convenience and should be used with discretion. Always use the appropriate hardware for the mounting surface.
- Constellation™ LED Drivers are 24VDC Constant Voltage output, and are dimmable with 0-10V dimmers ONLY.
- Constellation™ must be installed in dry locations ONLY.

April 30, 2018

Welcome to Constellation™

A Constellation configuration is built from LED hubs, connecting arms, end arms, and cable ceiling hangers. Illumination radiates through either the white optical acrylic lenses, or sparkles with refracted light through micro-faceted clear acrylic crystal lenses. Each hub is a complete LED light engine, using an array of LEDs with driver circuitry on each of the two faces of the hub. The connecting arms form a structural and electrical connection between the hubs, and are easily assembled by inserting the arm into the hub and are secured in place by a retaining set screw. The hubs can revolve around the connecting arms to alter the orientation of the illumination and that of the intersecting connecting arms. The configuration is supported by cable ceiling hangers that slide onto an arm and lock into place as needed, and is powered by a special power feed hub connected to the ceiling power feed.

WHAT COMES IN THE BOX

Triple Ceiling Hanger/Hanger Clips - Contains the cable ceiling hanger and stay clips as well as a parts bag necessary for configuration assembly.

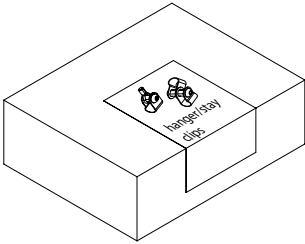

Hang Clip
(1)



Stay Clips
(2)



Small Hex
Wrench
(3+)

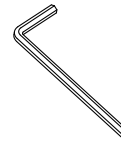

Large Hex
Wrench
(1)

Power Supply - Contains the LED Driver necessary for connecting to the branch circuit and housed in an enclosure for remote installation.

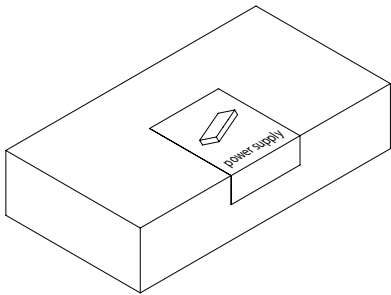

Remote Power Supply
(1)

Power Feed - Contains the power feed for attaching the configuration to the outlet box and connecting to the power supply. Also includes a parts bag necessary for installation.

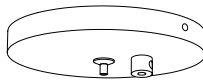
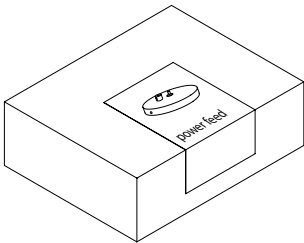

Power Feed
(1)



Canopy Set
Screw
(2)

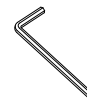

Medium Hex
Wrench
(1)

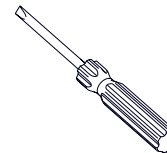

Screwdriver
(1)

Hubs - Contains the LED hubs, arranged by Aquila Major assembly sections and identified with a chart inside the box cover.

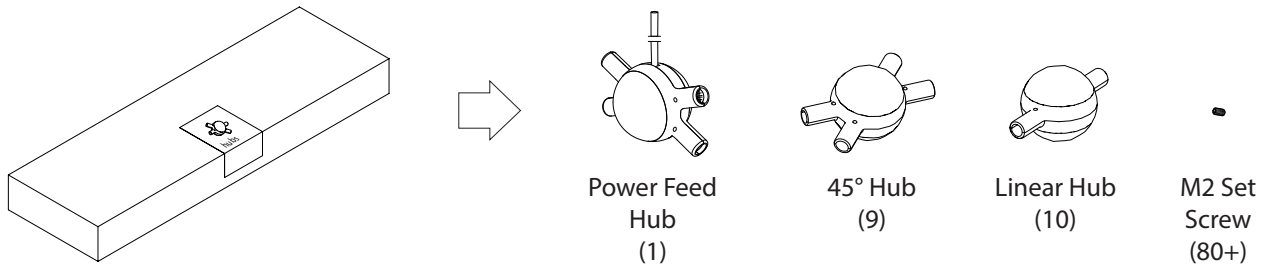

Section Boxes - Organized by assembly section, each box contains various sizes of connecting arms or end arms.

Section 1

Connecting Arms

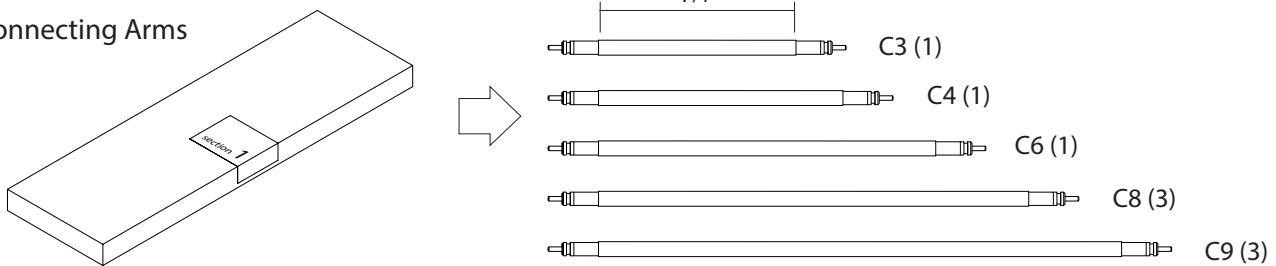

Section 2

Connecting Arms

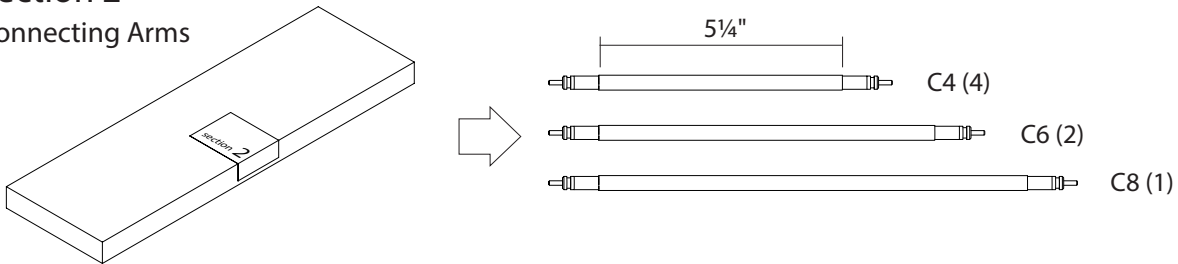

Section 3

Connecting/
End Arms

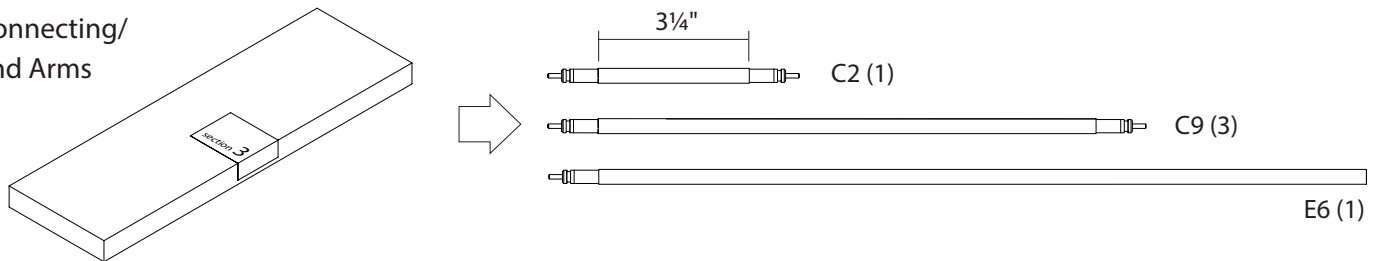

Section 4

End Arms

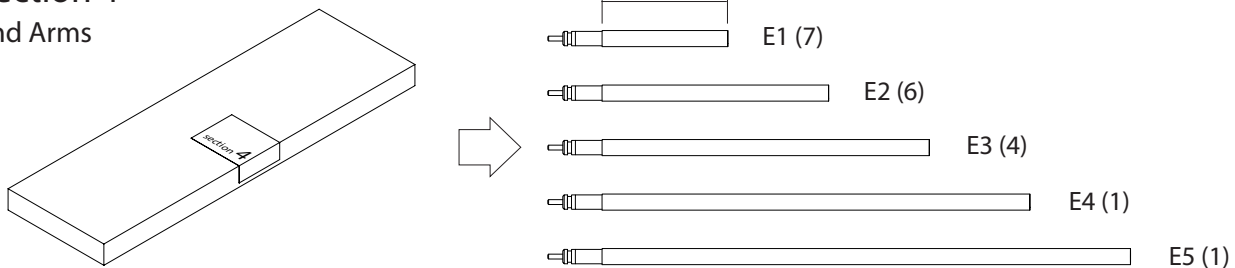

April 30, 2018

REMOTE POWER SUPPLY AND POWER FEED INSTALLATION

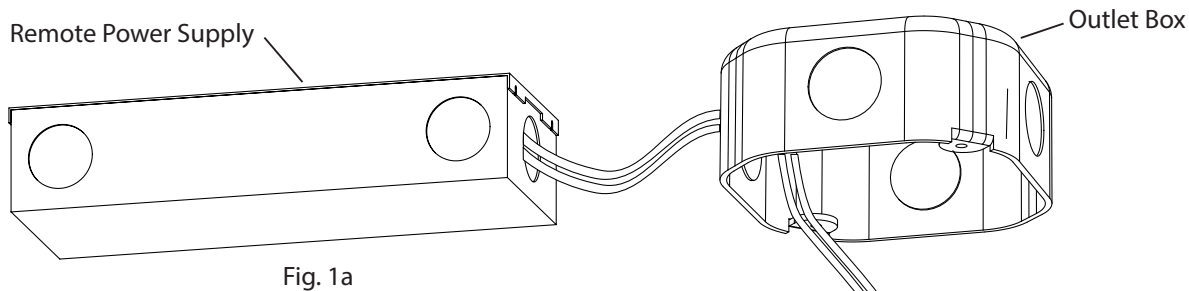

Remote Power Supply Installation (Fig. 1a):

1. Shut off power to the Outlet Box.
2. Install the Power Supply in a remote and accessible location near the fixture in accordance with local electrical code. Make appropriate electrical connections using wire nuts:
 - a. Connect the Power Supply's live wire (black) to the live supply wire.
 - b. Connect the Power Supply's neutral wire (white) to the neutral supply wire.
 - c. Connect the Power Supply's positive (+) output wire (red) to the required length of red wire (not included) to reach the Outlet Box.
 - d. Connect the Power Supply's negative (-) output wire (black) to the required length of black wire (not included) to reach the Outlet Box.

Power Feed and Section 1 Installation (Fig. 1b):

3. Install Section 1 (page 8) to the Power Feed by inserting the end of the Hang Clip Cable into the Cable Gripper until the Hang Clip is set to the desired height. To shorten the cable, push the cable up and it will be locked automatically. To lengthen the cable, lift up on the cable and push up on the gripper. While keeping the gripper depressed, lower the cable to the desired height and release the gripper to set. Reserve excess Cable in the Power Feed.
4. Feed the Cord on the Power Feed Hub through the Bushing on the Power Feed. Adjust the cord length the remove the slack, and secure with the Slotted Set Screw using the provided Screwdriver. Reserve excess Cord in the Power Feed.
5. Attach the Mounting Plate to the Outlet Box using the two (2) Outlet Box Screws.
6. Make appropriate electrical connections using wire nuts:
 - a. Connect the positive (red) low voltage wire from the Power Supply to the red side of the Power Feed Hub Cord.
 - b. Connect the negative (black) low voltage wire from the Power Supply to the black side of the Power Feed Hub Cord.
 - c. Carefully place the connections in the Outlet Box.
7. Install the Power Feed to the Mounting Plate and secure with Set Screws using the Medium Hex Wrench provided.

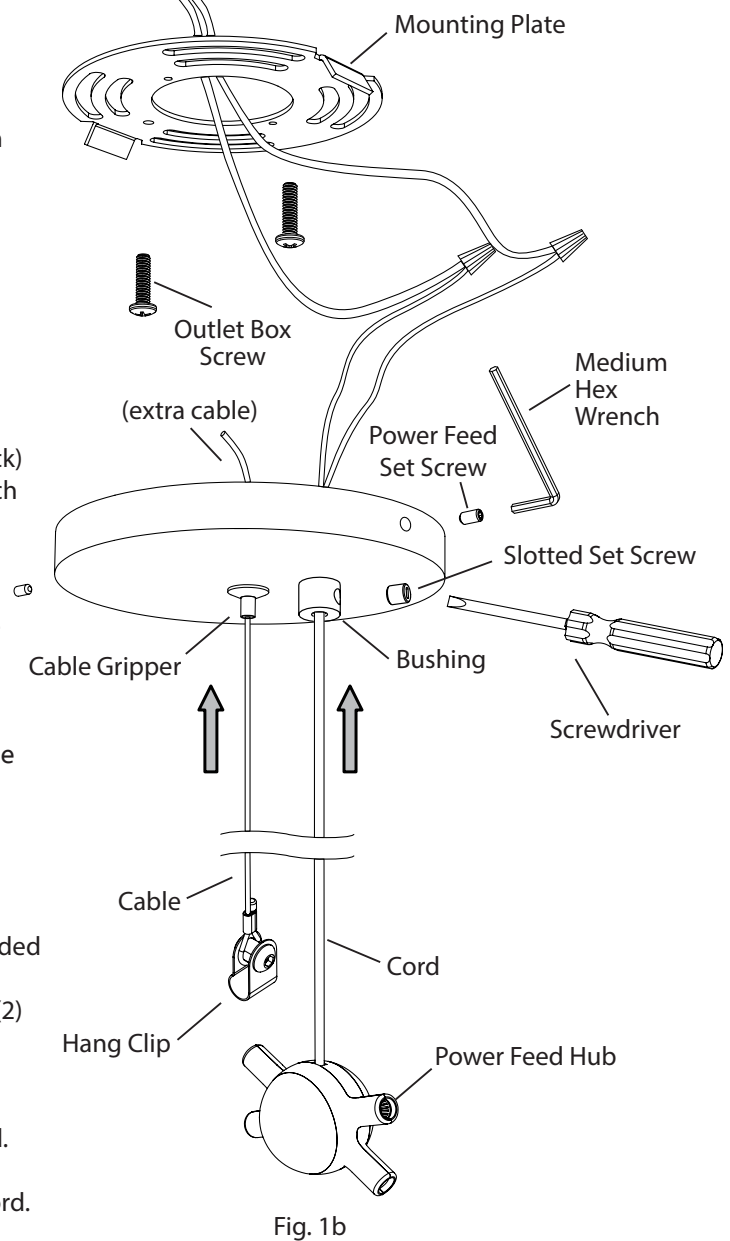

COMPONENT INSTALLATION
INSTRUCTIONS D'INSTALLATION

Arm and LED Hub Assembly:

1. Install each Arm into an LED Hub by fully inserting the Arm into a Neck on the Hub (Figs. 2a/2b).
2. After each Arm is connected to the Hub, install the M2 Set Screw into the Neck of the Hub, using the Small Hex Wrench provided, and tighten until it comes in contact with the plastic cap on the Arm. **DO NOT OVERTIGHTEN THE SCREWS.**

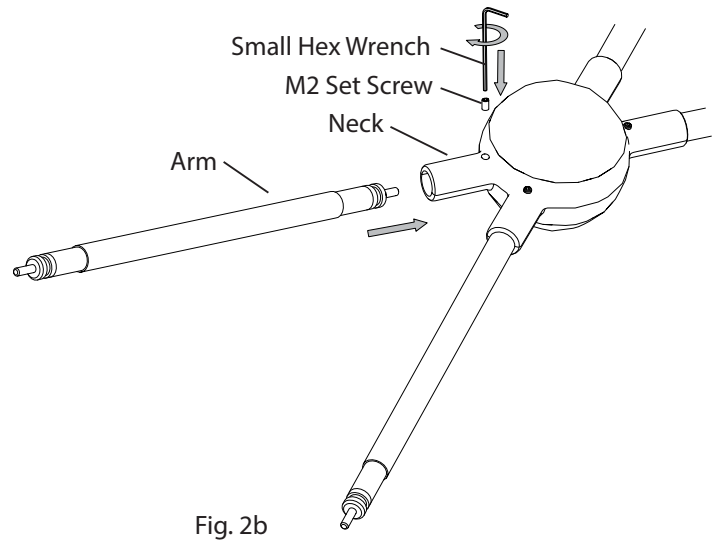
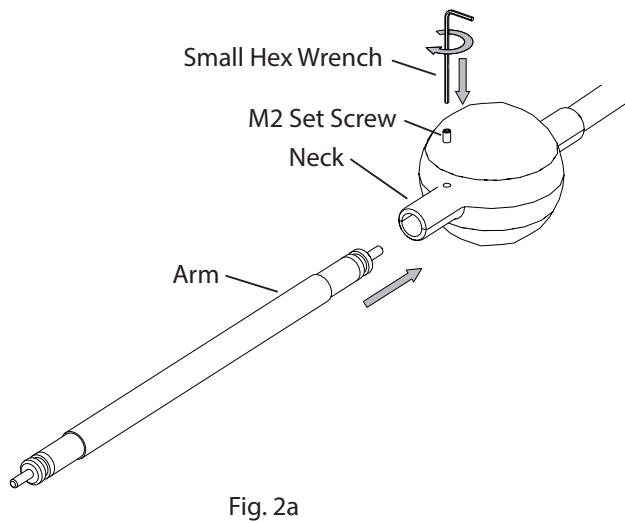

Arm and Hang Clip Assembly:

1. Install Arm into the Hang Clip (Fig. 3a) by sliding the Arm through the Clip.
2. Once the Arm is in the desired location, tighten the Screw using the Large Hex Wrench provided.

Arm and Stay Clip Assembly:

1. Connect 2 Arms together using the Stay Clip (Fig. 3b) by sliding each Arm through the Clips.
2. Once the Arms are in the desired positions, tighten the Screw using the Large Hex Wrench provided.

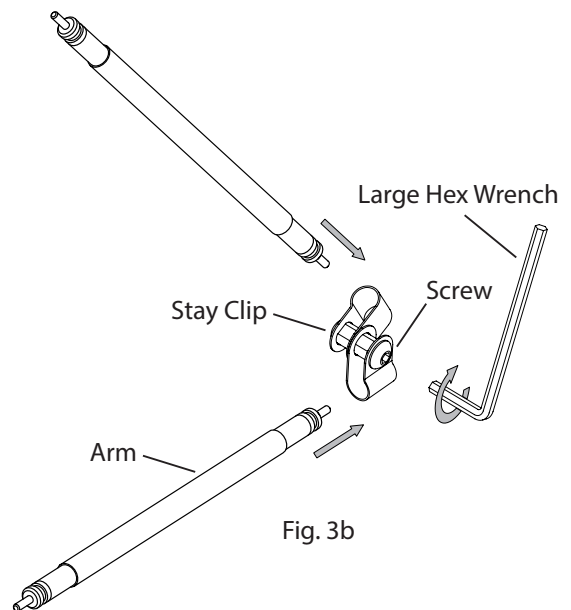
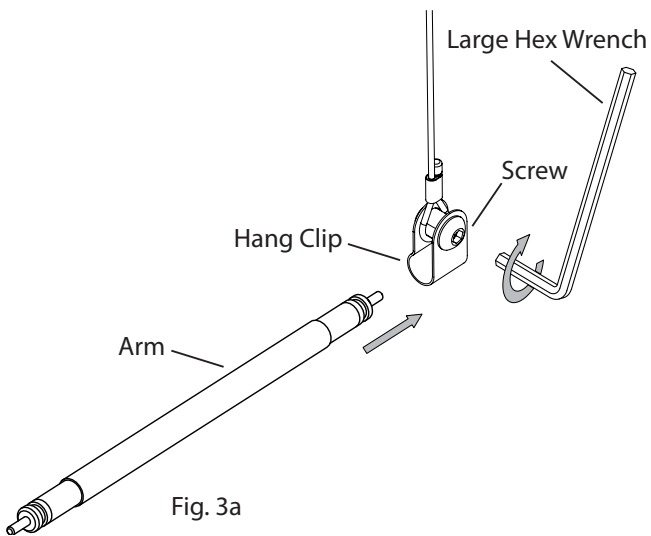

April 30, 2018

OVERVIEW OF ASSEMBLED AQUILA MAJOR

- Section 1 - page 8
- Section 2 - page 9
- Section 3 - page 10
- Section 4 - page 11

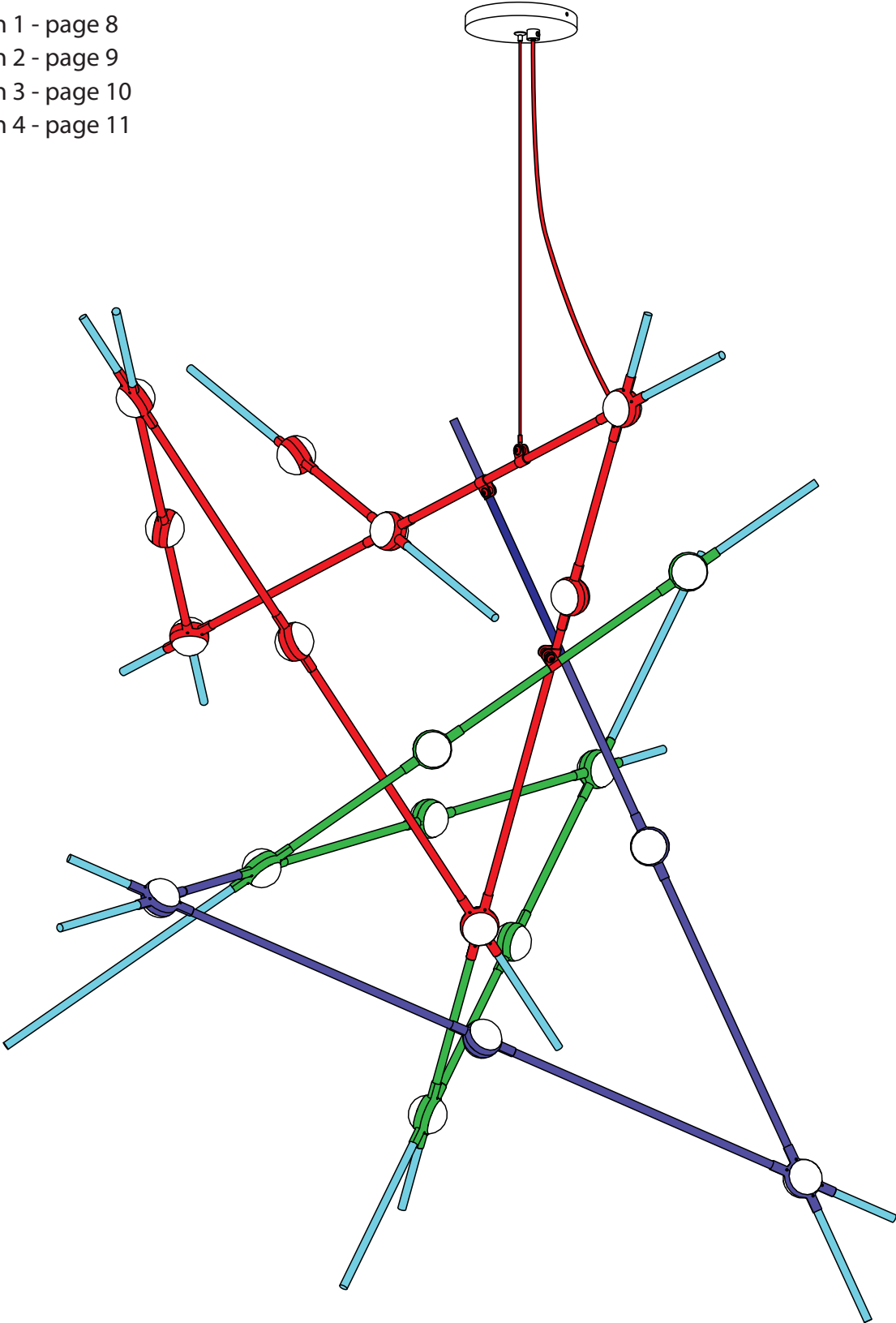

SECTION 1

- Build this section using the Hubs labeled Section 1 in the Hubs box, and Connecting Arms from the Section 1 box.
- Start by connecting a C9 Arm to a 45° Hub (1a), and insert into Stay Clip 1 (Fig. 4b), then insert into the Hang Clip and connect to the Power Feed Hub (1b) as shown below (Fig. 4a). Tighten the Hang Clip approx. 4" from the Power Feed Hub.
- Connect the Power Feed Hub to the Power Feed and install per the instructions on page 5.
- Continue by connecting the C4 Arm to the Power Feed Hub (1b), then connect a Linear Hub (1c), a C9 Arm, and Stay Clip 2 approx. 1" from the Linear Hub (Fig. 4a).
- Complete this Section by connecting Hubs and Arms following the order and pattern in Fig. 4a.

Arm Length Key	
C3	4¼" (1)
C4	5¼" (1)
C6	7¼" (1)
C8	9¼" (3)
C9	11¼" (3)

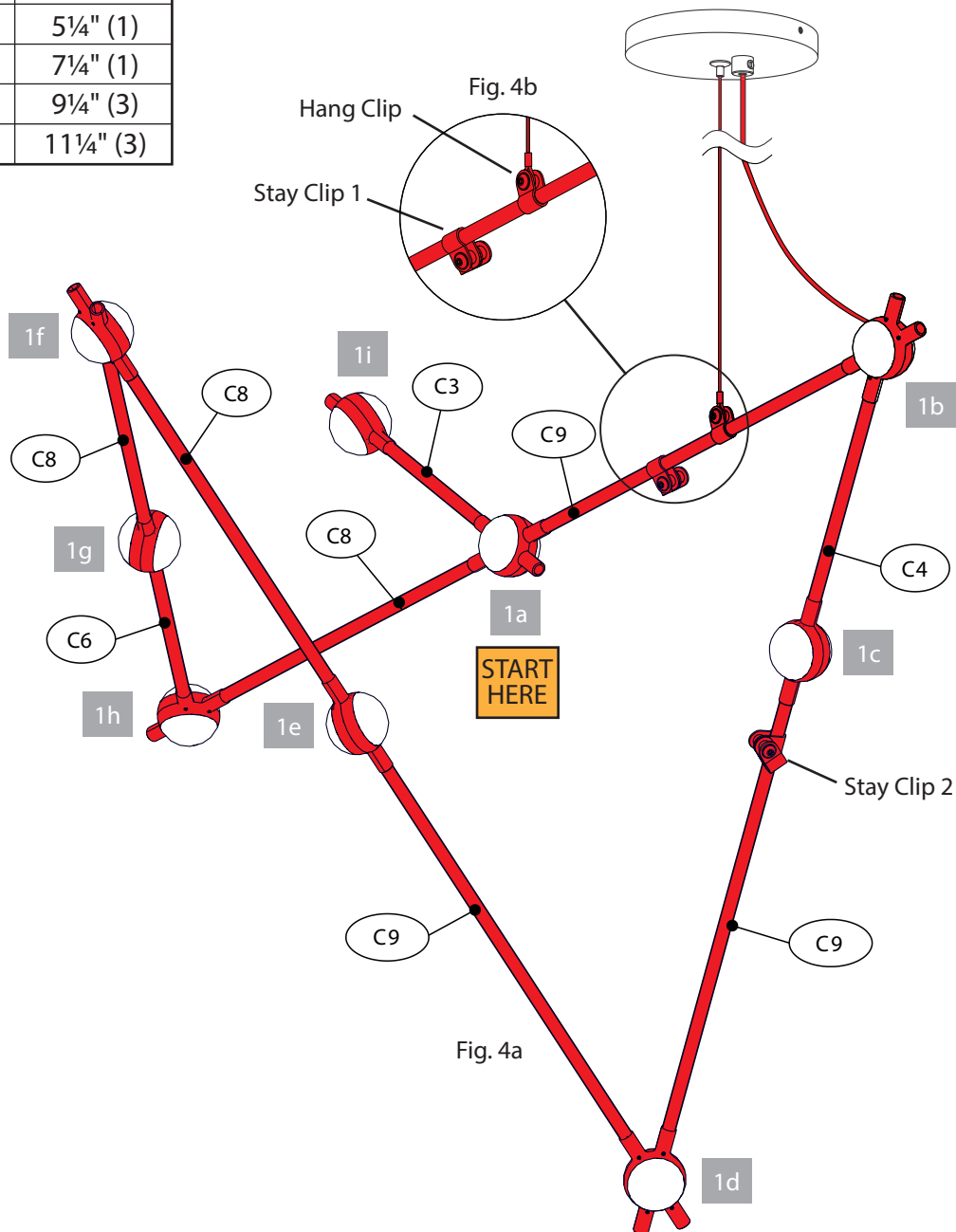

IMPORTANT:

Be sure to install all M2 Set Screws to secure the Arms to the Hubs, as shown on page 6.

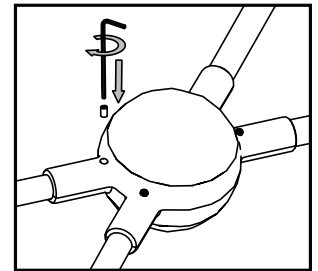

April 30, 2018

SECTION 2

- a. Build this section using the Hubs labeled Section 2 in the Hubs box, and Connecting Arms from the Section 2 box.
- b. Start by connecting the C8 Arm to a Linear Hub (2a) then pass this arm through Stay Clip 2 (Fig. 5a), refer to Stay Clip instructions on page 6, and continue by connecting a Linear Hub (2b) and a C4 Arm.
- c. Continue adding Hubs and Arms following the order and pattern in Fig. 5a, and complete this Section by connecting a C4 Arm to 45° Hub (1d) on Section 1.
- d. Adjust the position of Stay Clip 2 to the middle of the C8 Arm (approx. 4" from one end) and approx. 1" from the Linear Hub (1c) on Section 1.

NOTE: Do not tighten the screw on Stay Clip 2 until all Arms and Hubs have been connected.

Arm Length Key	
C4	5¼" (4)
C6	7¼" (2)
C8	9¼" (1)

IMPORTANT:
Be sure to install all M2 Set Screws to secure the Arms to the Hubs, as shown on page 6.

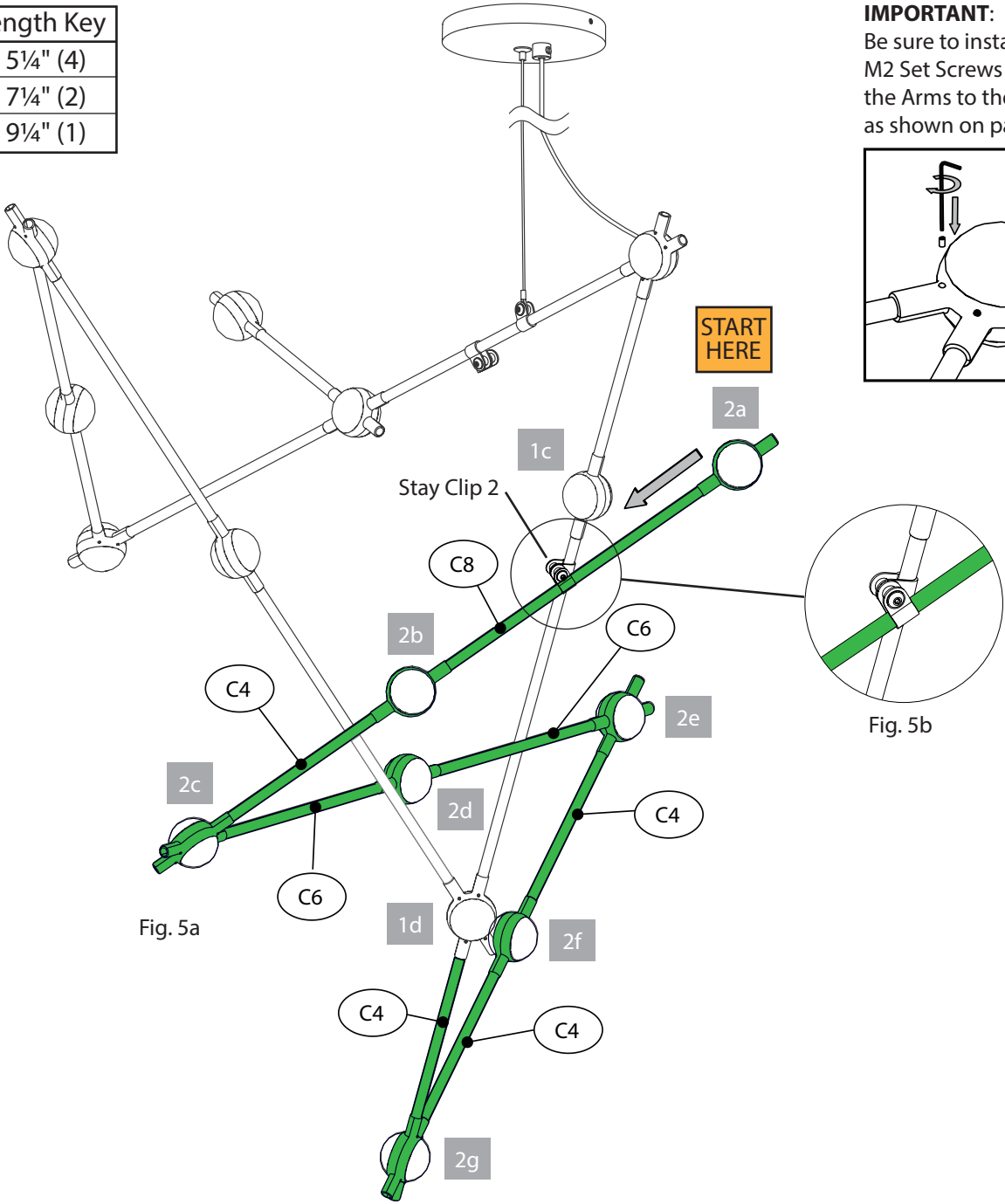

SECTION 3

- Build this section using the Hubs labeled Section 3 in the Hubs box, and Connecting Arms from the Section 3 box.
- Start by connecting the E6 Arm to a Linear Hub (3a) then pass this arm through Stay Clip 1 until the arm end is approx. 2" from the clip (Fig. 6b), refer to instructions on page 6. Continue by connecting a C9 Arm to the Linear Hub (3a), followed by a 45° Hub (3b).
- Add the remaining Arms and Hubs following the order and pattern in Fig. 6a, and complete this Section by joining the C2 Arm onto the 45° Hub (2c) on Section 2.
- If necessary, adjust the position of Stay Clip 1 by loosening the set screw. Tighten the screw to complete this section.

Arm Length Key	
C2	3¼" (1)
C9	11¼" (3)
E6	16½" (1)

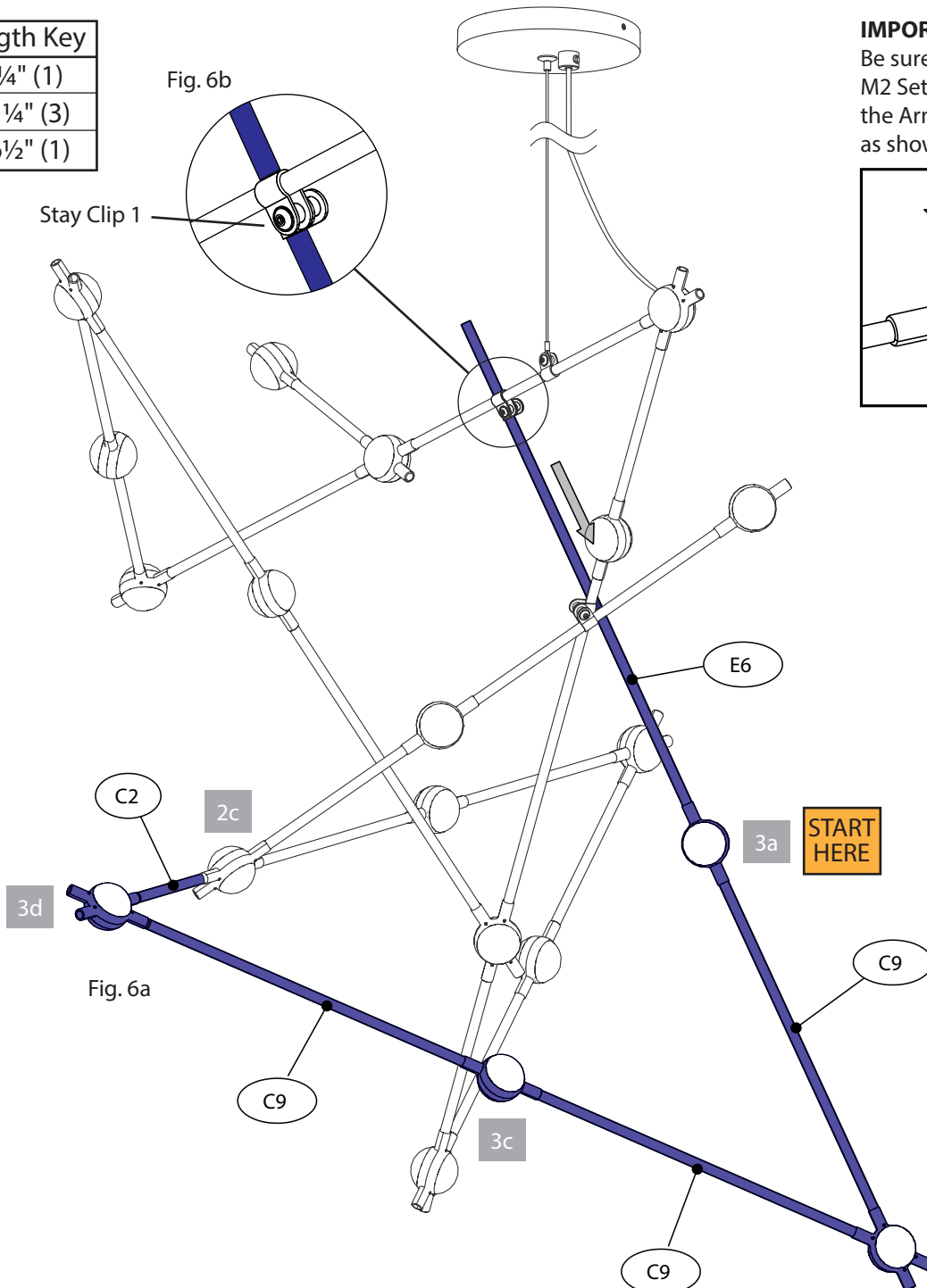

IMPORTANT:

Be sure to install all M2 Set Screws to secure the Arms to the Hubs, as shown on page 6.

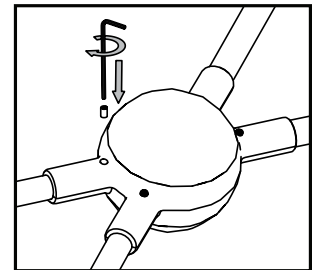

April 30, 2018

ADDING THE END ARMS (Section 4)

- a. Build this section using the End Arms from the Section 4 box.
- b. Refer to the illustration below (Fig. 7) to secure each of the End Arms, there is no specific order for installing these.

Arm Length Key	
E1	2½" (7)
E2	4½" (6)
E3	6½" (4)
E4	8½" (1)
E5	10½" (1)

IMPORTANT:
Be sure to install all M2 Set Screws to secure the Arms to the Hubs, as shown on page 6.

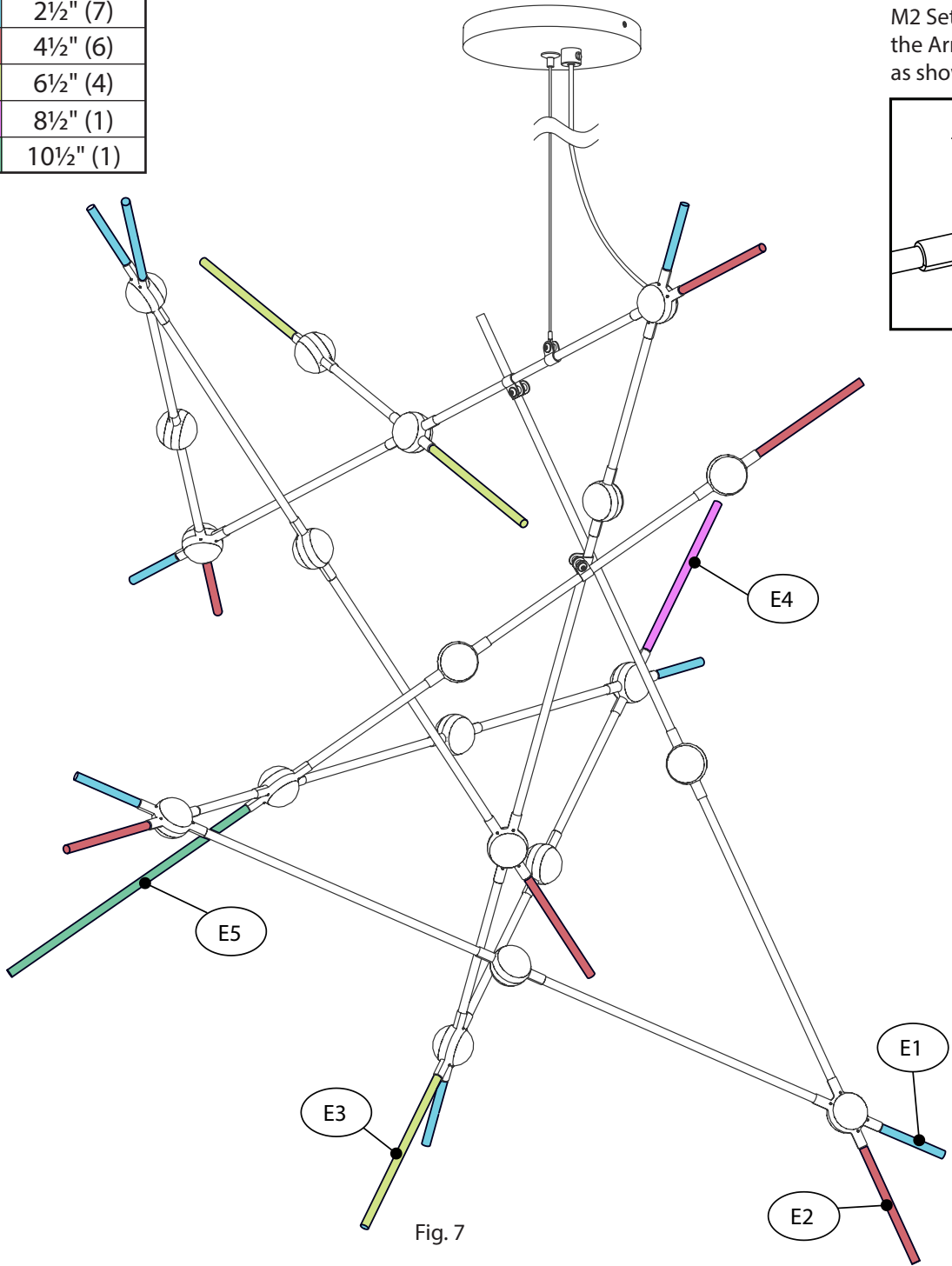
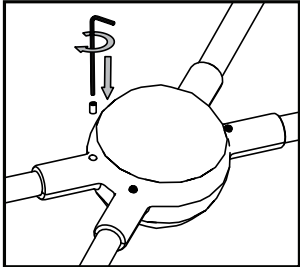

Fig. 7

COMPLETED ASSEMBLY

