



OUTPLAY THE ORDINARY

by Lausaint Home

V2.1



HARDTOP GAZEBO INSTALLATION

12x16 FT

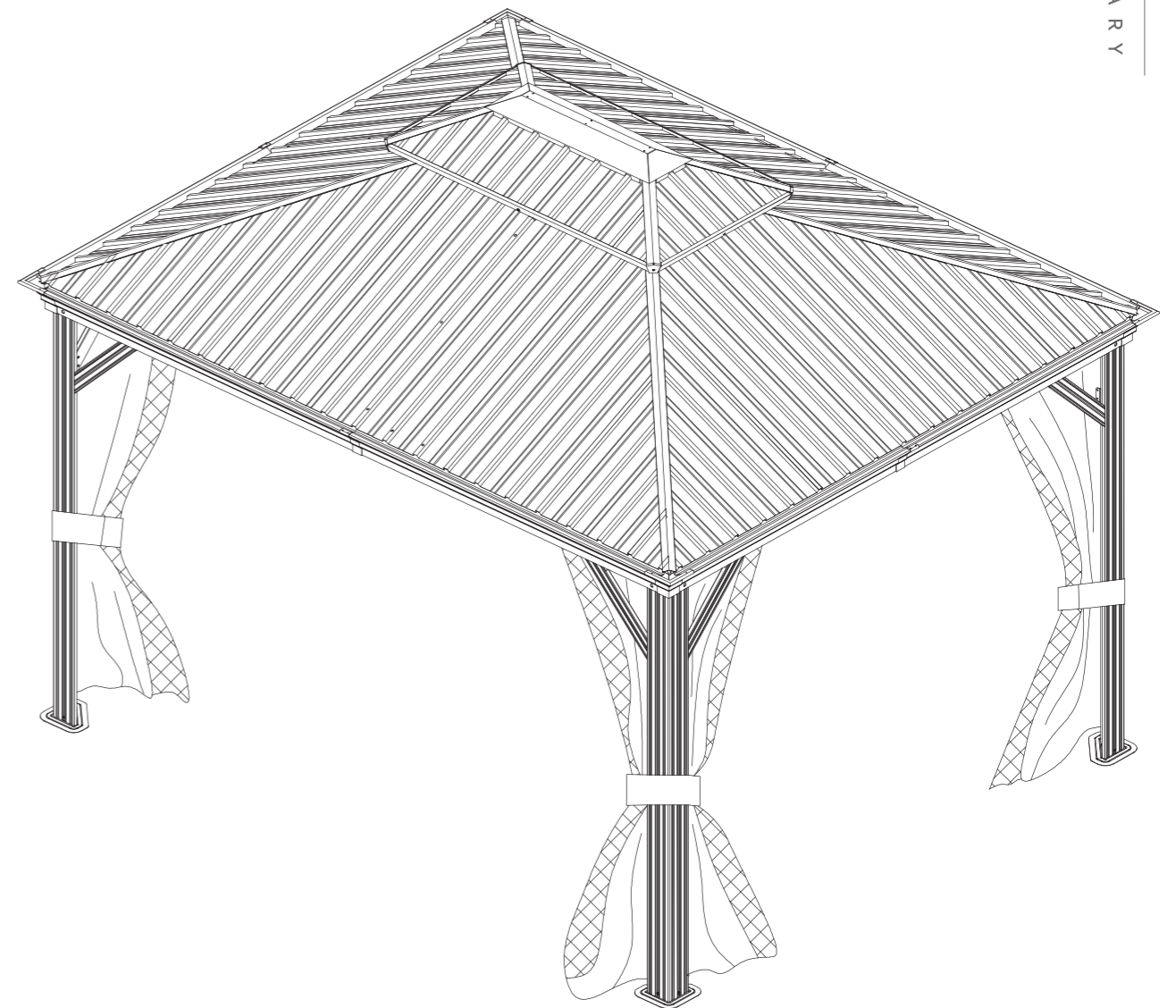

OUTPLAY THE ORDINARY

SKU GSM001-N01-S-1
customerservice@lausaint.com

INSTRUCTION BOOK



ATTENTION	02
IMPORTANT SAFETY INSTRUCTIONS	03
GENERAL PREPARATIONS	04
REQUIREMENTS TOOLS	05-08
COMPONENT LIST	09
HARDWARE LIST	10
ASSEMBLY STEPS	11-37
· BASE FRAME INSTALLATION	12-20
· TOP FRAME INSTALLATION	21-25
· TOP PLATE INSTALLATION	26-33
· ACCESSORY INSTALLATION	34-37



WARNING!

WARNING! TO REDUCE THE RISK OF SERIOUS INJURY, READ THE FOLLOWING SAFETY INFORMATION.



IMPORTANT SAFETY INSTRUCTIONS

CAUTION!

Always keep children under close supervision while they are playing around with this product. Never leave children unattended. Keep pets away while setting up the gazebo.

CAUTION!

Check municipal by-laws before installing the gazebo.

- This product is intended for domestic outdoor use only.
- The product should be placed and assembled on flat, horizontal ground.
- Consult with your local governing authority/local municipal codes regarding the installation of temporary structures before assembly.
 - Ensure there is enough clearance around the product. Before assembling the gazebo, make sure to leave a distance of not less than 6 ft (1.8 m) from any structures or obstructions, such as fences, garages, houses, overhanging branches, laundry lines, or electrical wires.
 - Anchor the gazebo to the ground with stakes for added safety. Stakes are provided to secure the gazebo to the floor. If you wish to secure the gazebo to a concrete or wood surface, use anchors suited for these surfaces (anchors not included). Do not assemble the gazebo on sandy, muddy or loose soil, as stakes do not have enough anchorage in these types of soil.
 - If more than one gazebo is set up, keep a minimum distance of 10 ft (3 m) between the gazebos.
- Any assembly or maintenance of the product must be carried out by adults only.
- Make sure there is sufficient manpower when assembling or moving the product.
- Some parts may contain sharp edges. Wear protective gloves if necessary.
- Check all nuts and bolts periodically to ensure their tightness. When required, tighten them.
- Repairing and replacing parts should be done by a qualified technician.
- This gazebo is intended for decorative purpose and to provide sunshade only.
- The gazebo is not designed to withstand harsh weather, including high winds, rain, and snow. Always remove the gazebo in such heavy weather conditions otherwise it might tip over and cause damage to the product or injuries to bystanders.
 - During snow days, remove the snow at the top when the snow is thicker than 4 in (10 cm).
 - After a period of time, usually in 2–3 months, tighten all the bolts.
 - After some time outdoors, the gazebo roof may get dirty. Rinse the top of the gazebo using water. Do not use harsh cleaning agents.
 - Do not hang any weights on the roof frame.
 - Do not climb onto the roof of the gazebo. Falling off the gazebo can result in serious injury.
 - Use paint of similar color for touch-ups. It is recommended to use outdoor paint.

CAUTION!

- Proper placement of the gazebo is essential. Do not place the product underneath electrical lines.
- Keep children under close supervision while they are playing around with this product.
- This product contains small parts which can be swallowed by children.
- Keep fingers away from places where they can be pinched or trapped.
- Do not attempt to assemble the gazebo if any part is missing.
- Do not light any fires inside or near the product!
- Stay calm if a fire breaks out. Search for the nearest exit. Do not return to the gazebo until the fire department deems it safe.

LET US HELP YOU! DO NOT RETURN YOUR PRODUCT TO THE STORE.

If you have questions regarding your product, require warranty assistance, or have damaged or missing parts, please contact us through this email customerservice@lausaint.com. Contact us for assistance; we're here to help.

IMPORTANT

Please read and understand this manual before any assembly!
We recommend at least three adults to complete the installation. Three adults installed together will make the installation process easier and safer.
Before beginning the assembly of the product, make sure all the component parts available.
Unpack and place all the parts from the packaging box in an open area and position them on the floor. Remove all packing materials and put them back into the box.
Do not dispose of the packing materials until assembly is complete. Read each step carefully before beginning any assembly, and make sure you understand each step. If you are missing a part, please contact us for assistance.

CAUTION!

Disassemble the gazebo in reverse order of the steps used to assemble it.
Always disassemble the gazebo completely. A partially-disassembled gazebo is not stable enough to resist wind and bad weather, therefore can be damaged and/or cause damage.





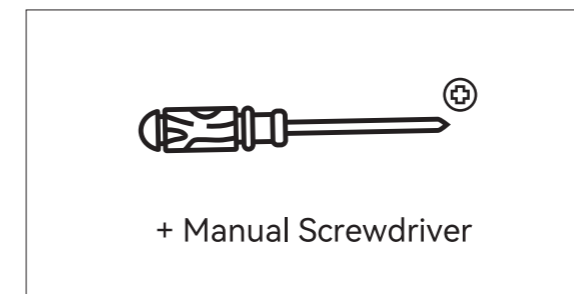
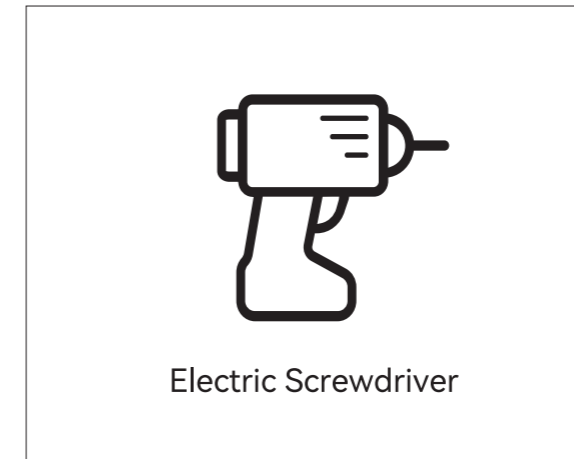



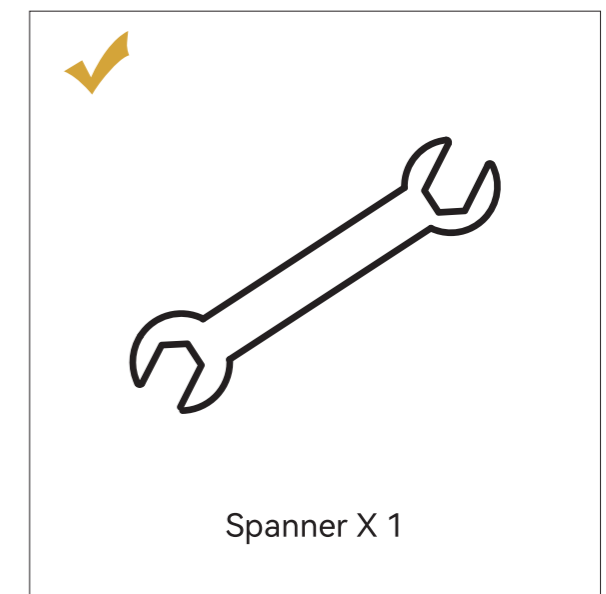
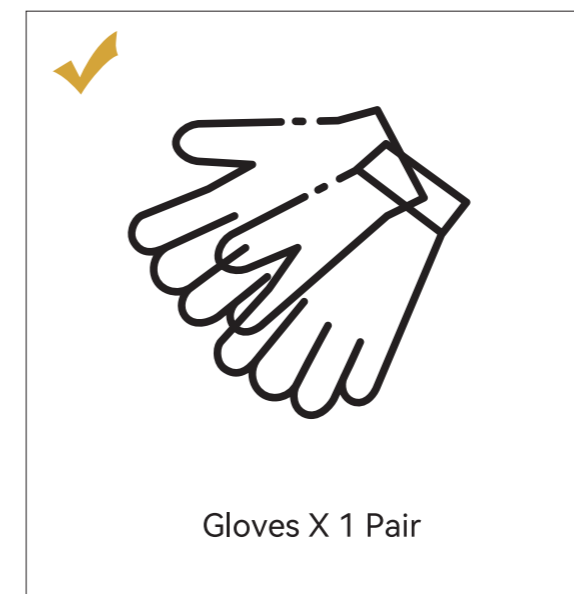

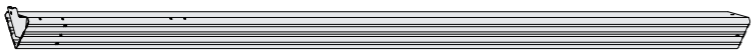

- When choosing the location for your gazebo build, plan to have at least 6 ft (approximately 1.8 m) of clearance beyond the footprint of the gazebo to allow for installing parts. This is in conjunction with the Important Safety Instructions.
- It is very important that you install the gazebo on a flat, level surface. A surface that is not flat and level will make it difficult to square the frame, which will make assembly more difficult.
- Save your cardboard! You can use the box as padding when assembling the gazebo to prevent damage to parts during assembly.
- Lay out all parts before beginning assembly and compare the parts you have to the parts list in this manual. If parts are missing, please contact customerservice@lausaint.com to have replacement parts provided to you.
- Completely read through this assembly manual before beginning assembly so you can become familiar with the building process.

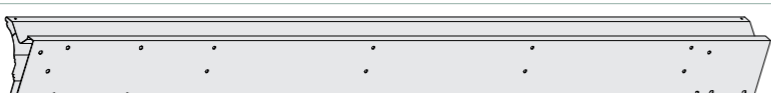
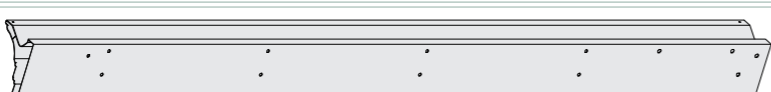
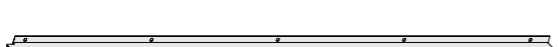









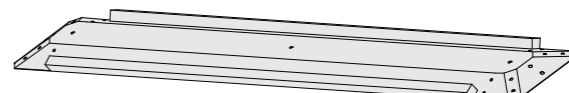

PACKAGE NOT INCLUDED



TOOLS PACKAGE INCLUDE







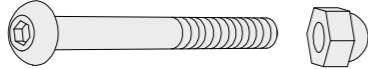
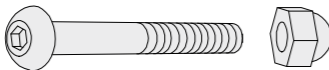
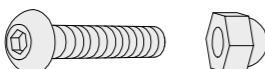

PARTS #	QTY	DESCRIPTION
A	4	
B	2	
B1	2	
B2	2	
C	4	
C1	4	
C2	2	
C3	2	
D	2	
D1	2	
D2	2	
D3	2	
D4	2	
G	4	

PARTS #	QTY	DESCRIPTION
G1	4	
G2	2	
G3	4	
H	1	
H1	1	
J	2	
J1	2	
K	4	
K1	2	
K2	4	
X	4	
X1	4	
X2	2	
X3	2	

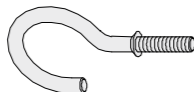
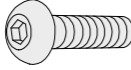
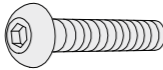
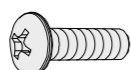
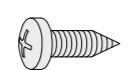
PARTS #	QTY	DESCRIPTION	PARTS #	QTY	DESCRIPTION
E	6		N2	8	
F1	4		N3	110+5	
F2	4		N4	6	
L	4		Q	72+2	
L1	6		Q1	16+1	
M	4		Ra	2	
M1	8		Rb	2	
M2	8		R1	4	
N	6		R2	4	
N1	4		Y	128+6	

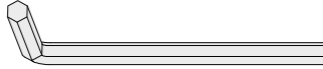
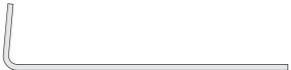
PARTS #	QTY	DESCRIPTION	PARTS #	QTY	DESCRIPTION
P	2		W5	2	
P1	2		W6	2	
P2	2		W7	2	
P3	2		S	2	
P4	4		S1	2	
P5	2		S2	2	
P6	2		S3	2	
W	2		S4	4	
W1	2		S5	2	
W2	2		S6	2	
W3	2		S7	2	
W4	2		S8	2	

PARTS #	QTY	DESCRIPTION
Z	18+2	 M6 x 47mm
Z1	4+1	 M6 x 42mm
Z2	86+3	 M6 x 23mm
V	16+1	
V1	2	
U	264+5	 M6 x 15mm
U1	27+2	 M6 x 23mm
U2	50+3	 M5 x 15mm
T	28+3	 ST4.8 x 12mm
AA	1	
BB	1	
CC	1	
DD	8+1	
PZ	8+1	

• BASE FRAME INSTALLATION

STEP 01-09 12-20

• TOP FRAME INSTALLATION

STEP 10-14 21-25

• TOP PLATE INSTALLATION

STEP 15-22 26-34

• ACCESSORY INSTALLATION

STEP 23-26 35-37

 Two Times Required

 Four Times Required

 The dotted line represents the installation track.

STEP

01

BASE FRAME INSTALLATION

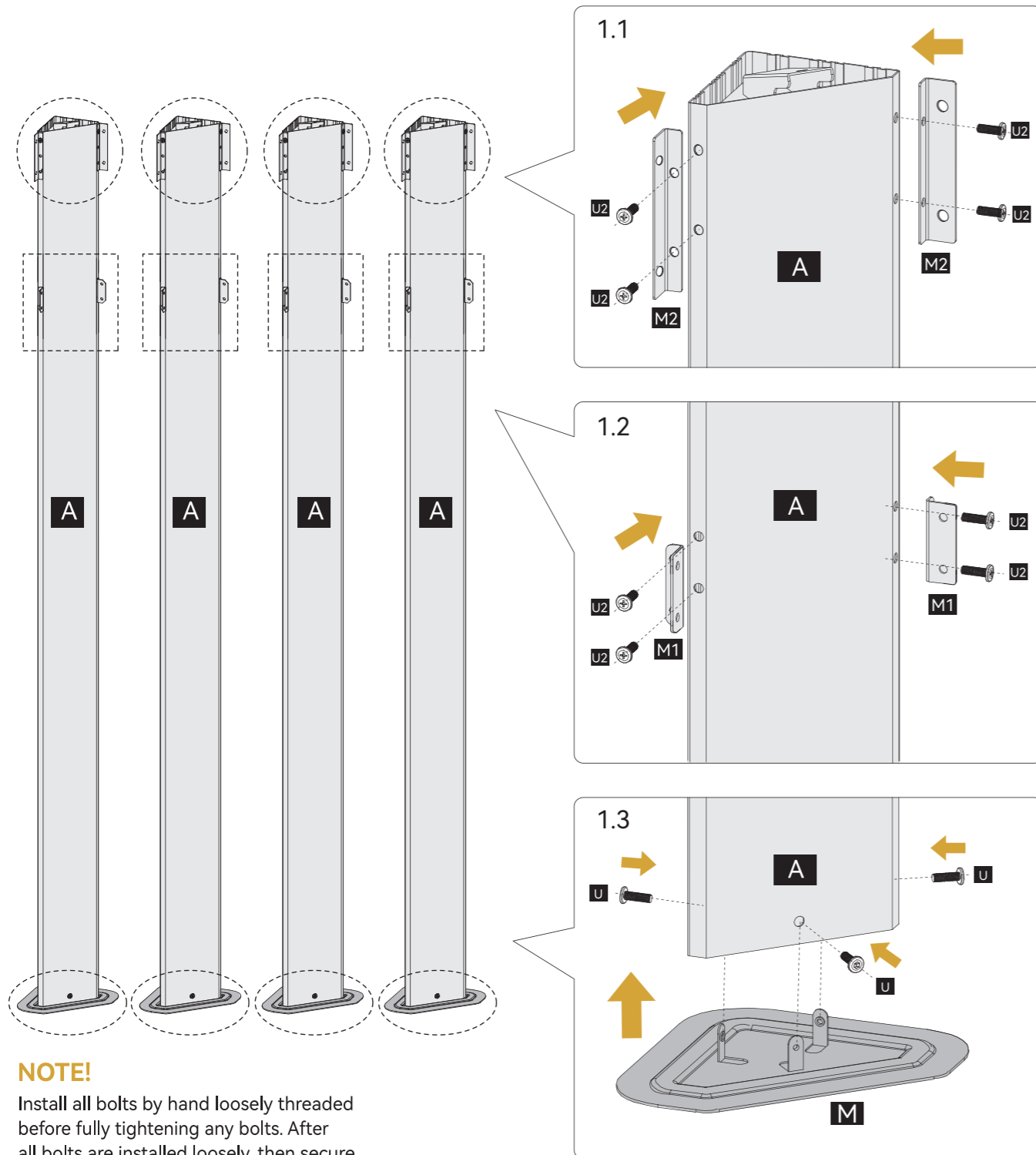
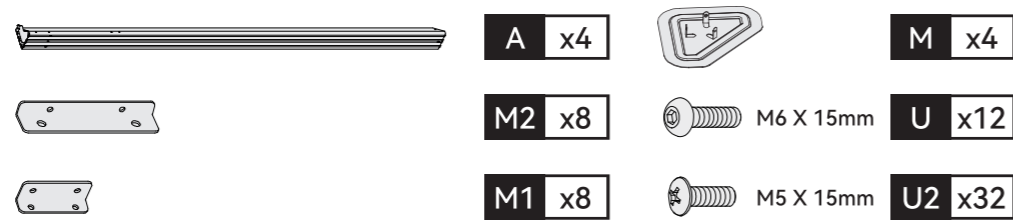

NOTE!

Install all bolts by hand loosely threaded before fully tightening any bolts. After all bolts are installed loosely, then secure the bolts before moving on to the next step.

BASE FRAME INSTALLATION

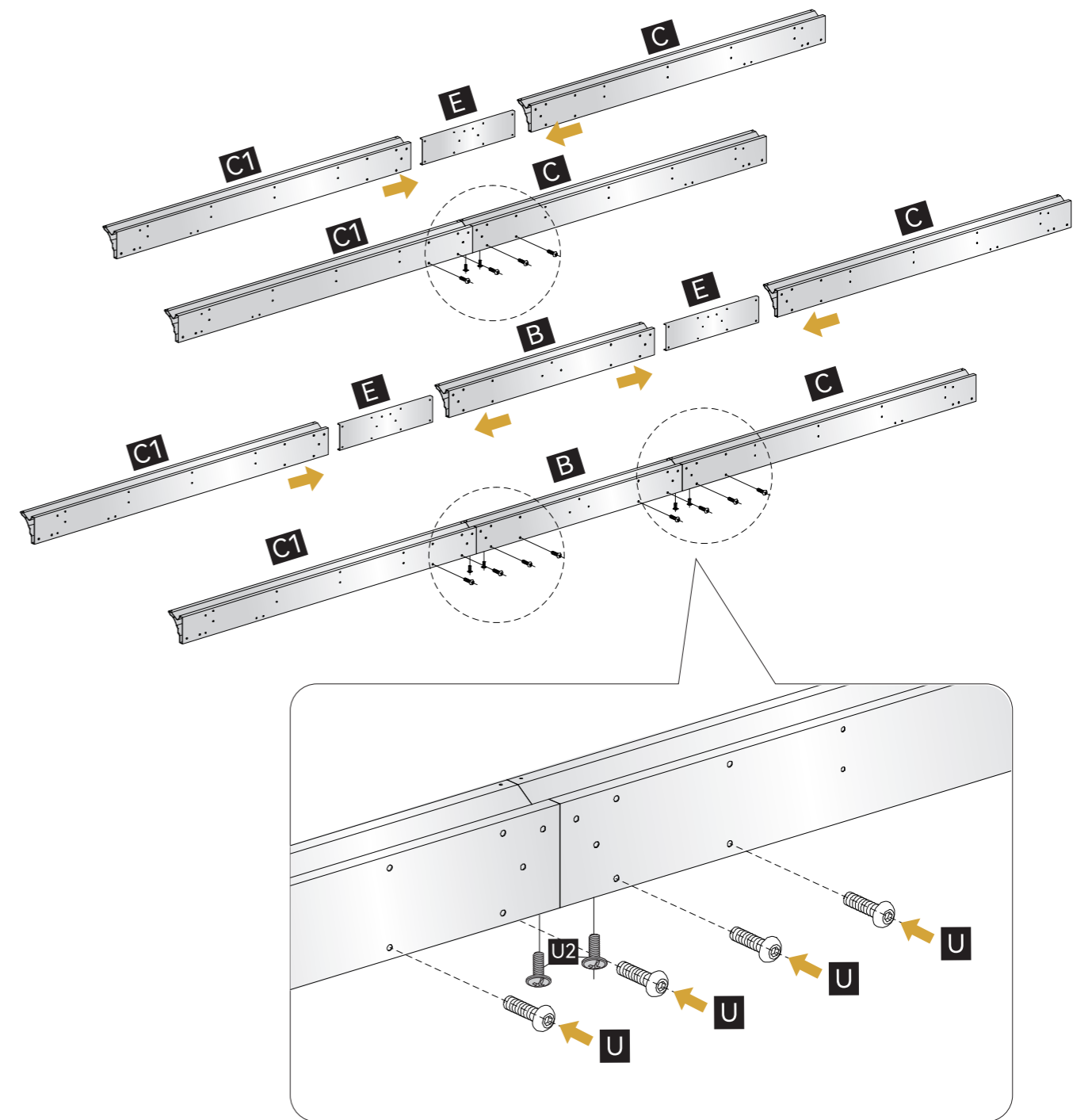
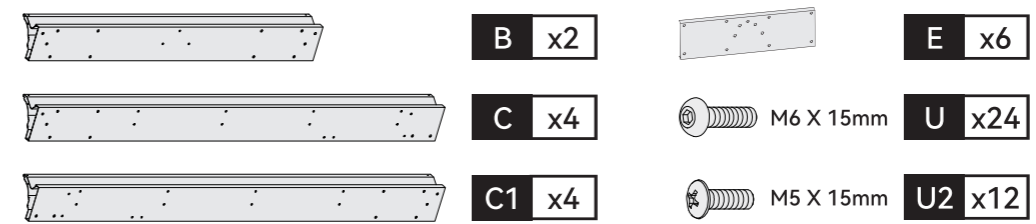

STEP

02

STEP



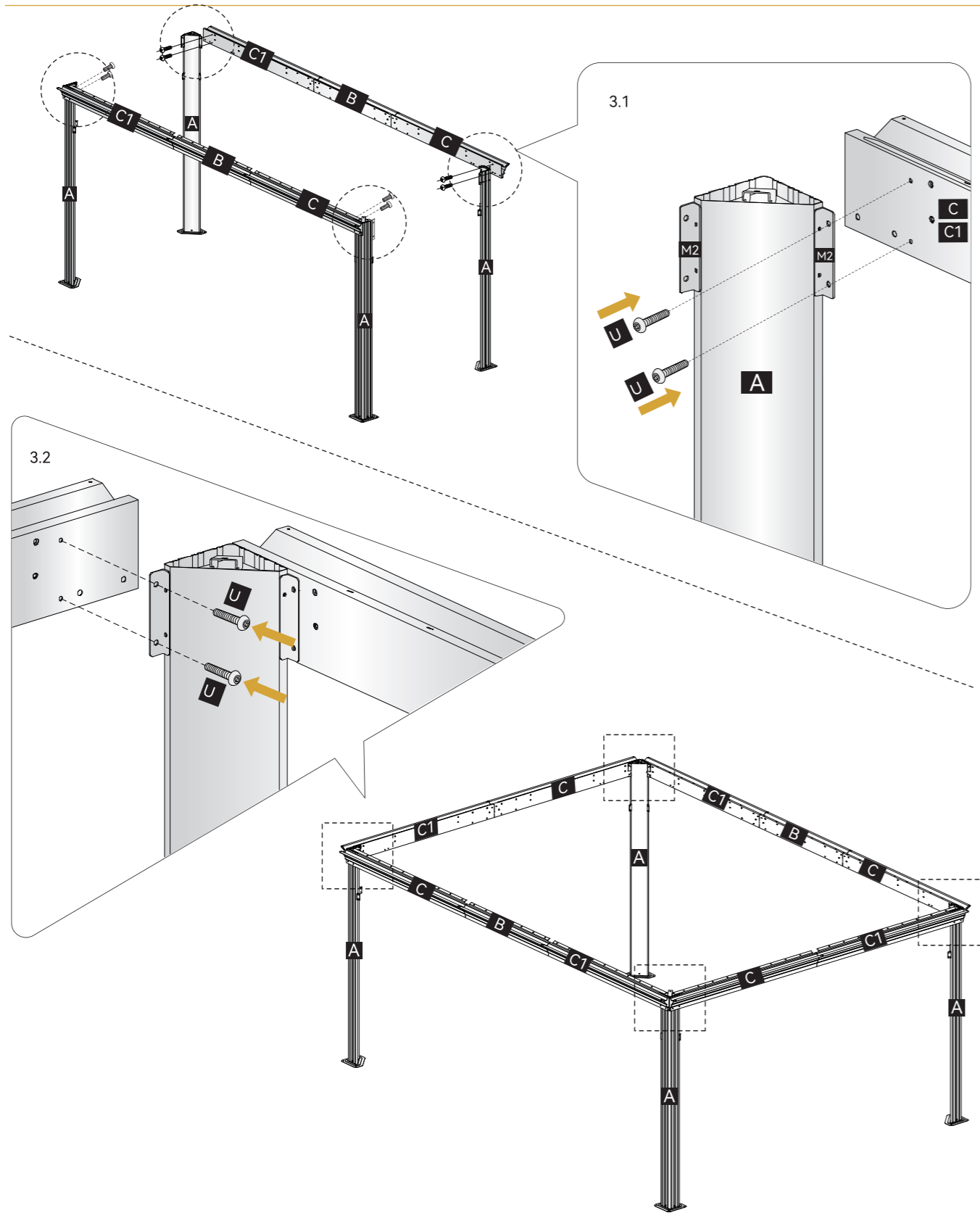

03

BASE FRAME INSTALLATION

M6 x 15mm U x16

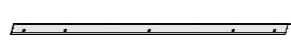

BASE FRAME INSTALLATION

 **D x2**  **D1 x2**
 **D2 x2**  **M6 x 15mm U x58**
 **D3 x2**
 **D4 x2**

STEP

04

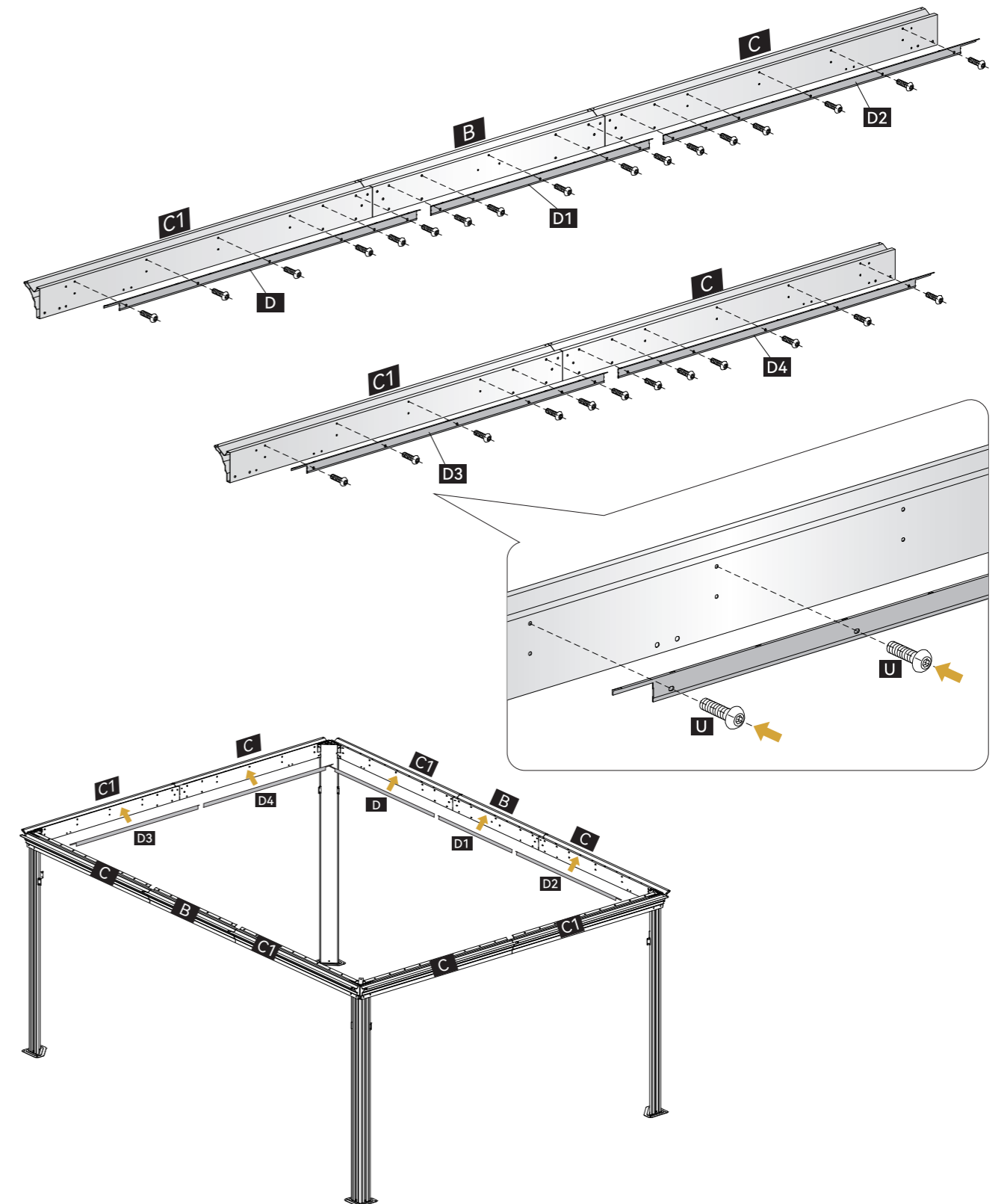

STEP 05

BASE FRAME INSTALLATION

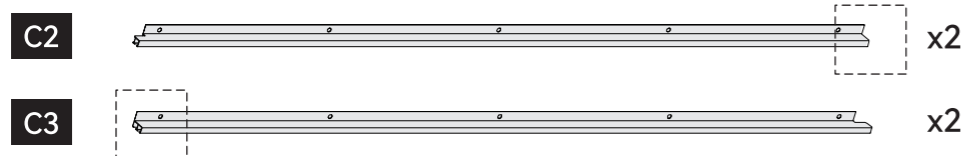
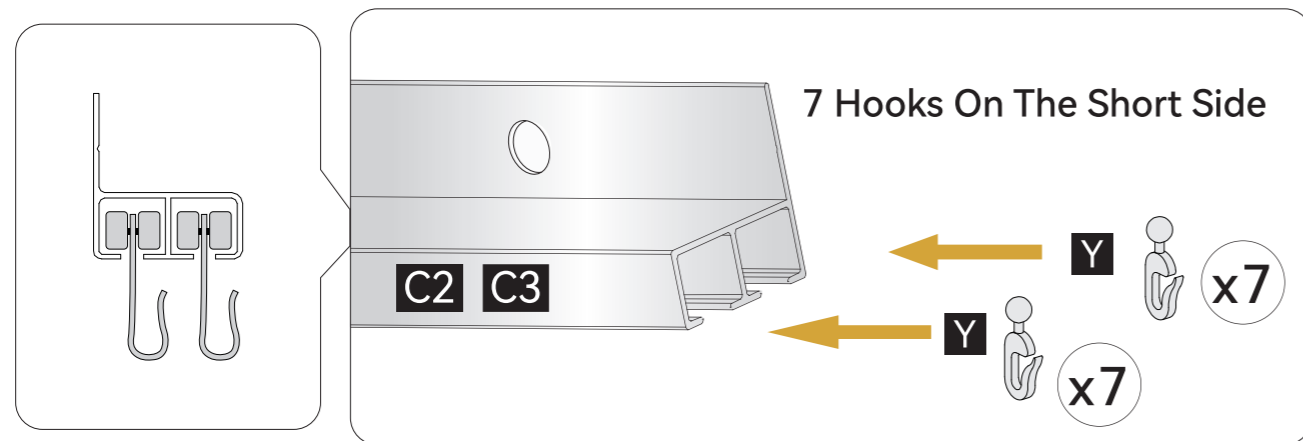
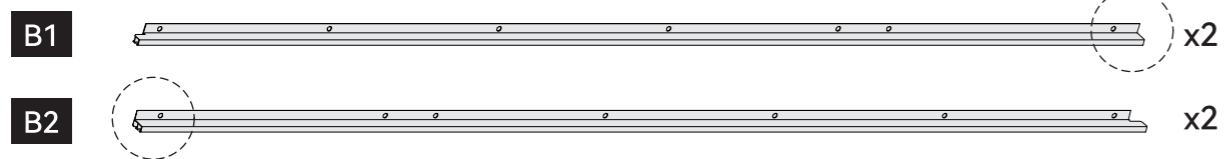
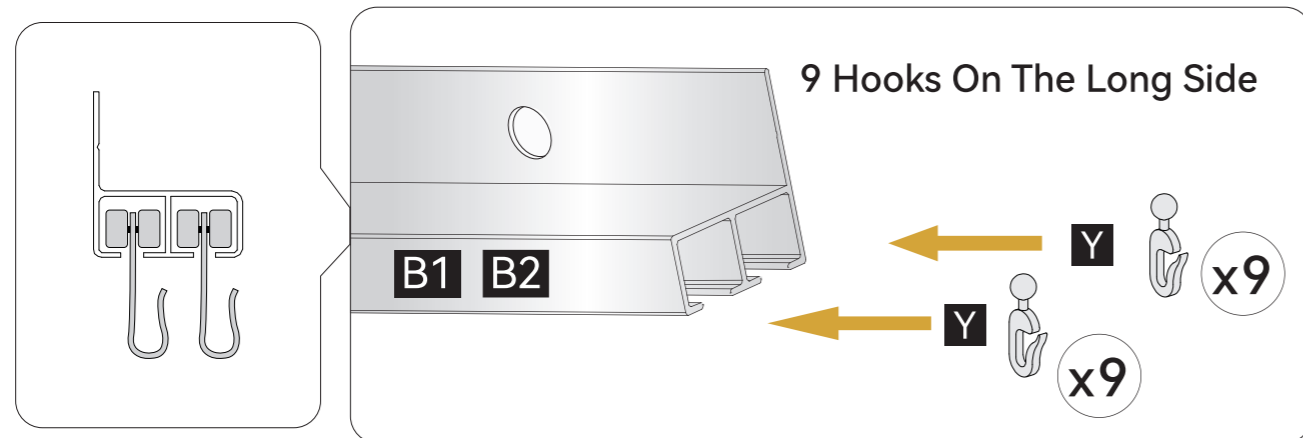
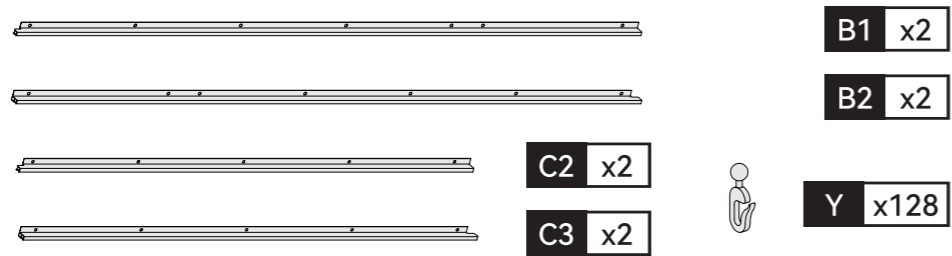

BASE FRAME INSTALLATION

STEP 06

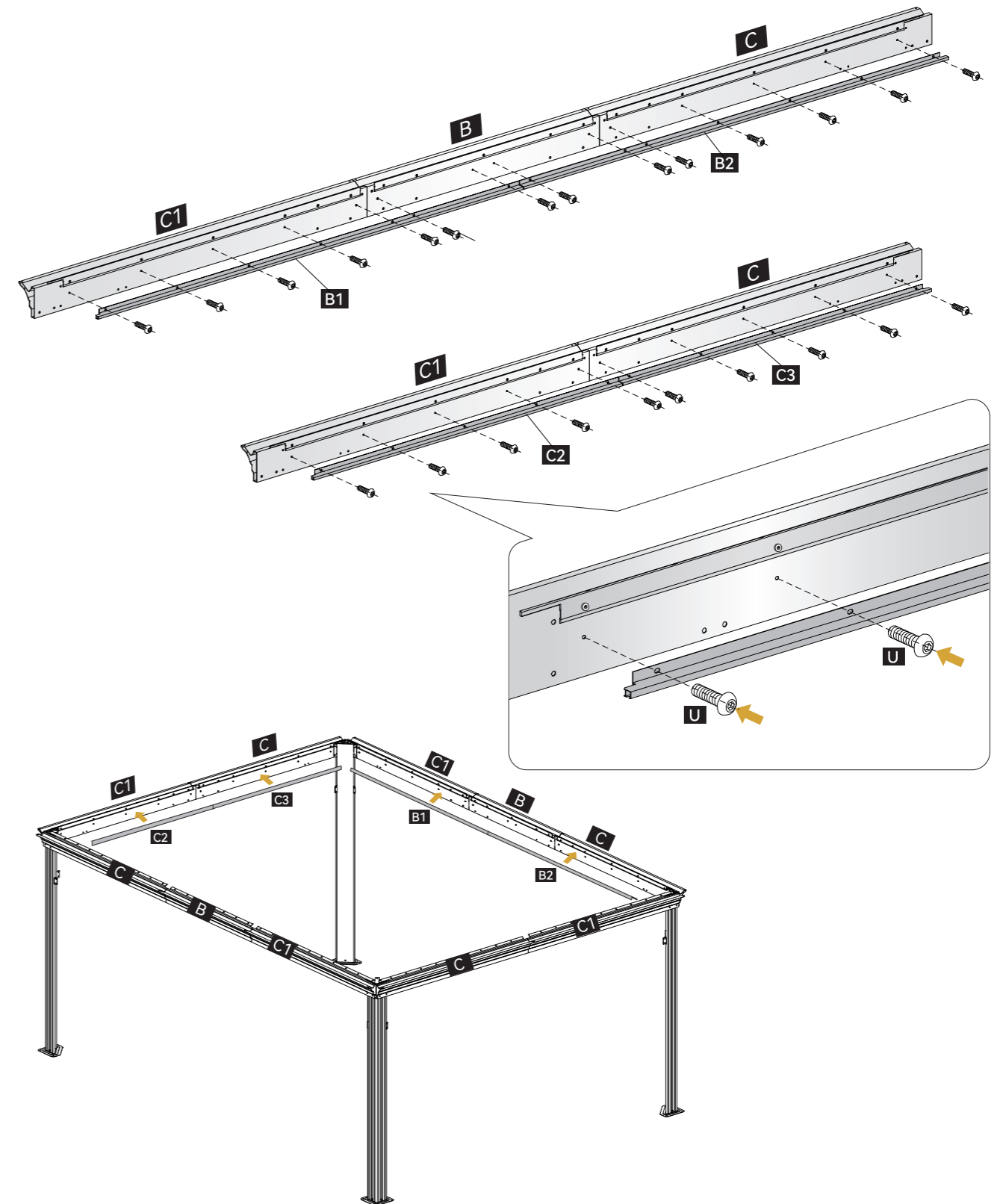

STEP

07

BASE FRAME INSTALLATION



V x16

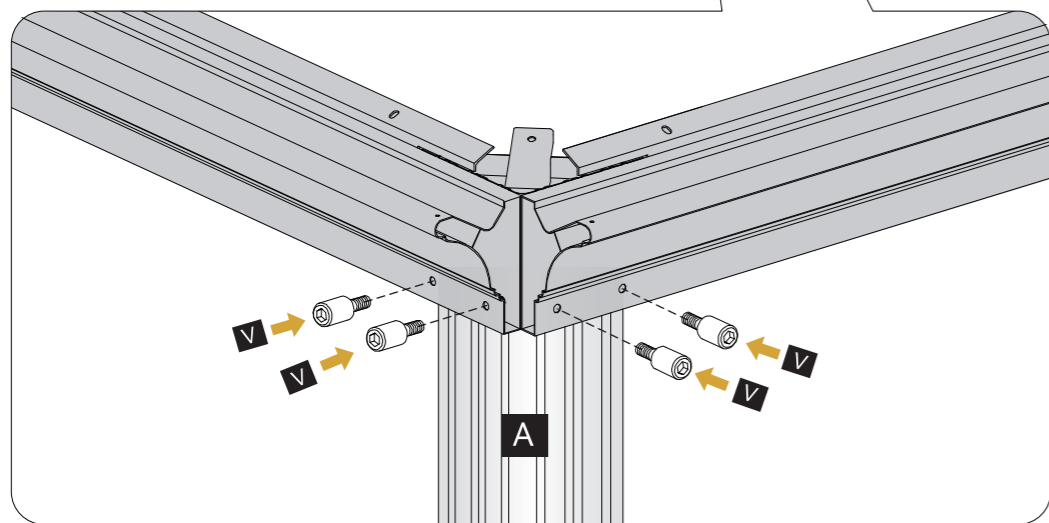
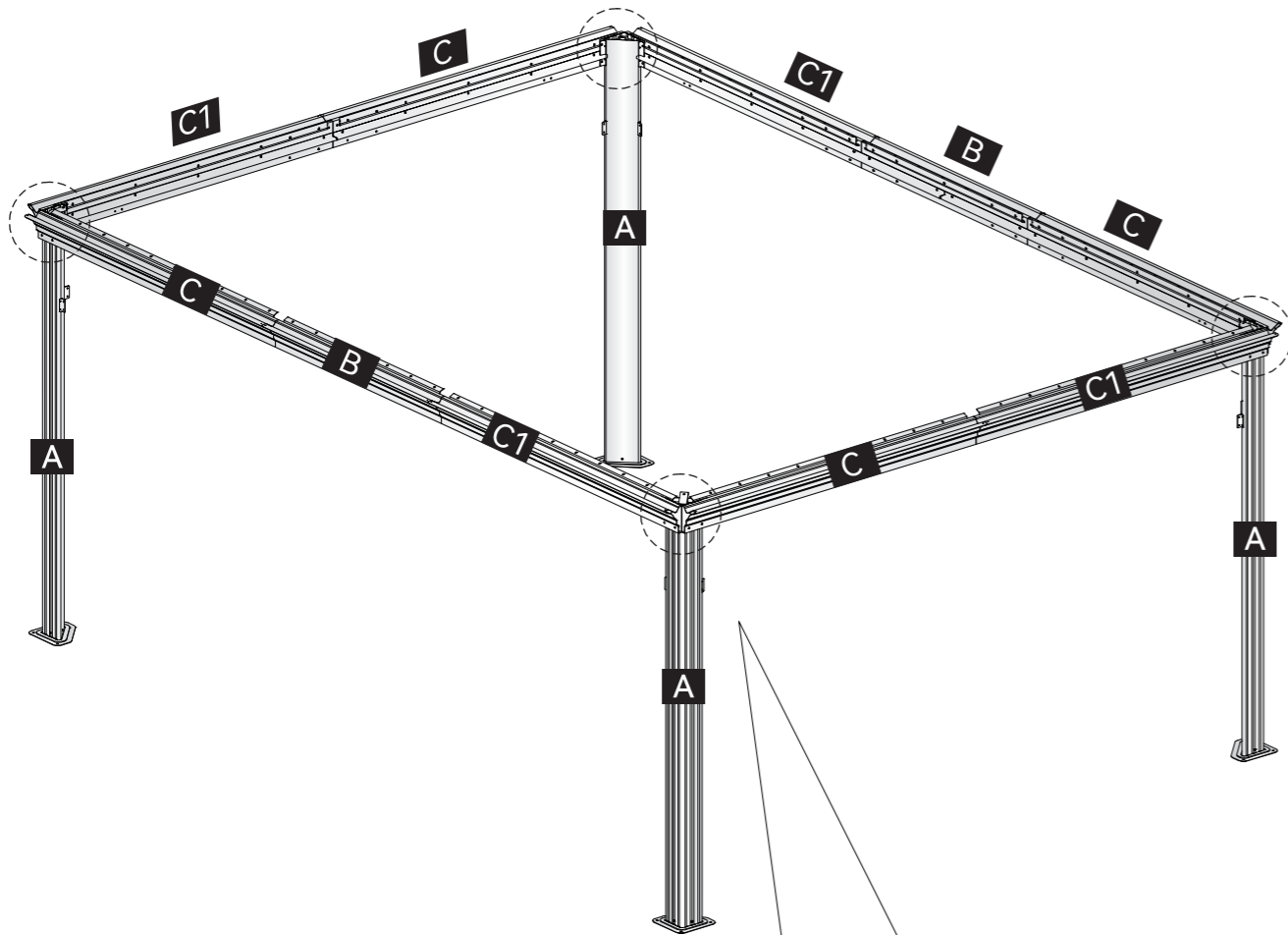

BASE FRAME INSTALLATION

STEP

08

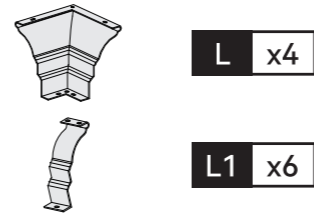

L x4

L1 x6



M5 x 15mm

U2 x6



ST4.8 x 12mm

T x28

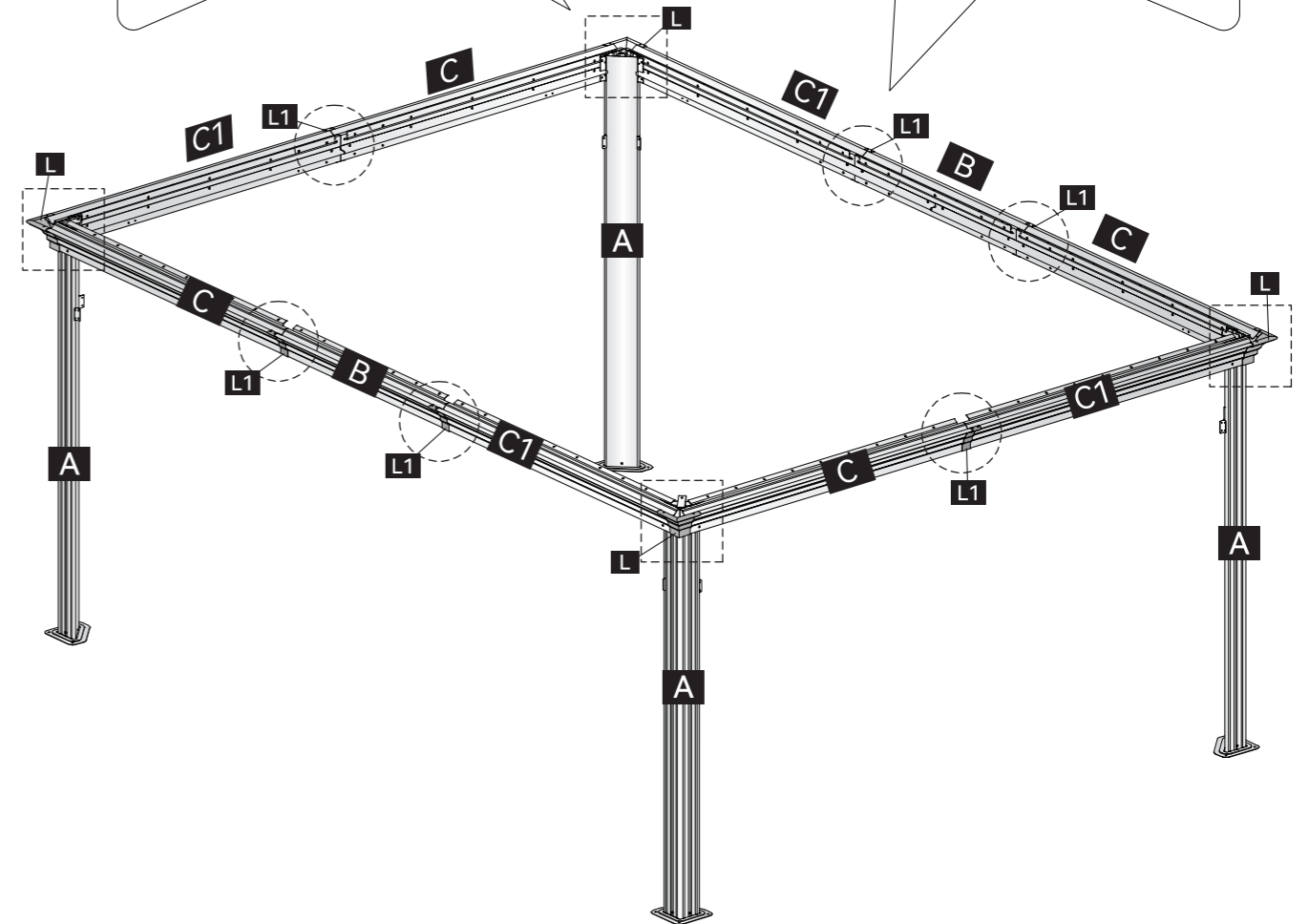
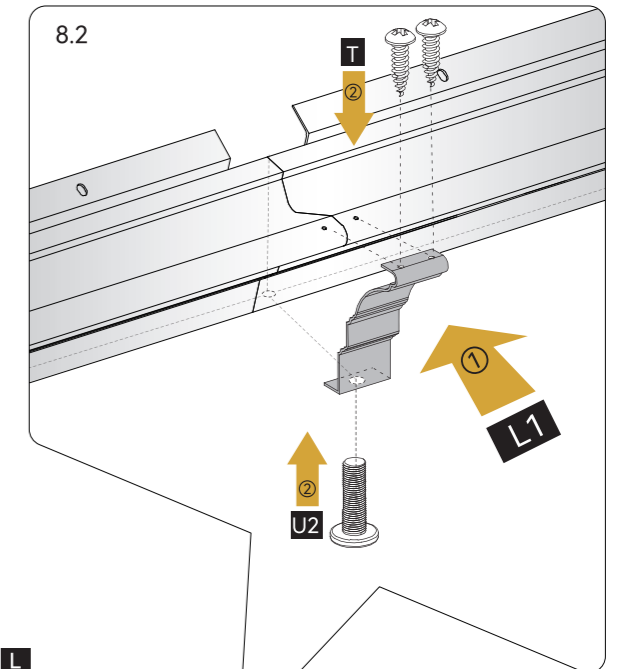
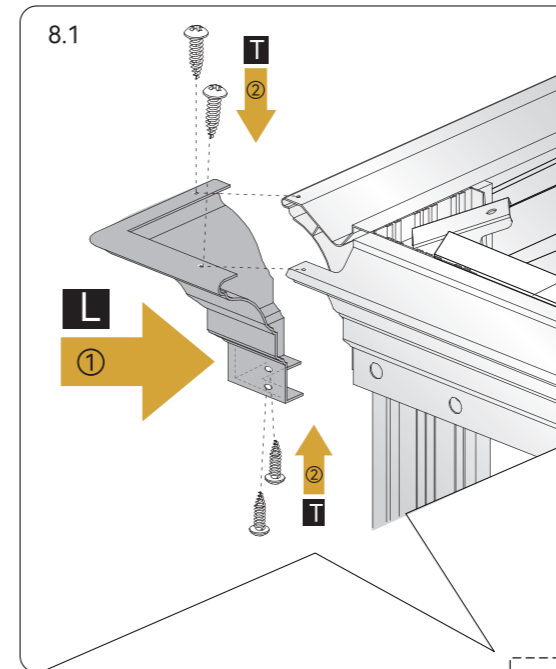

STEP

09

BASE FRAME INSTALLATION



F1 x4

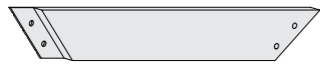

F2 x4

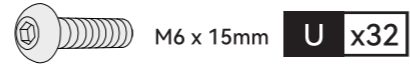

M6 x 15mm U x32

9.1

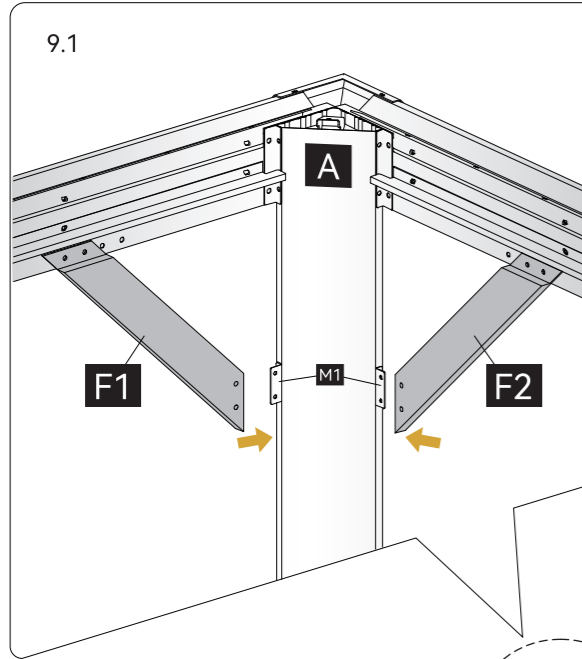

9.2

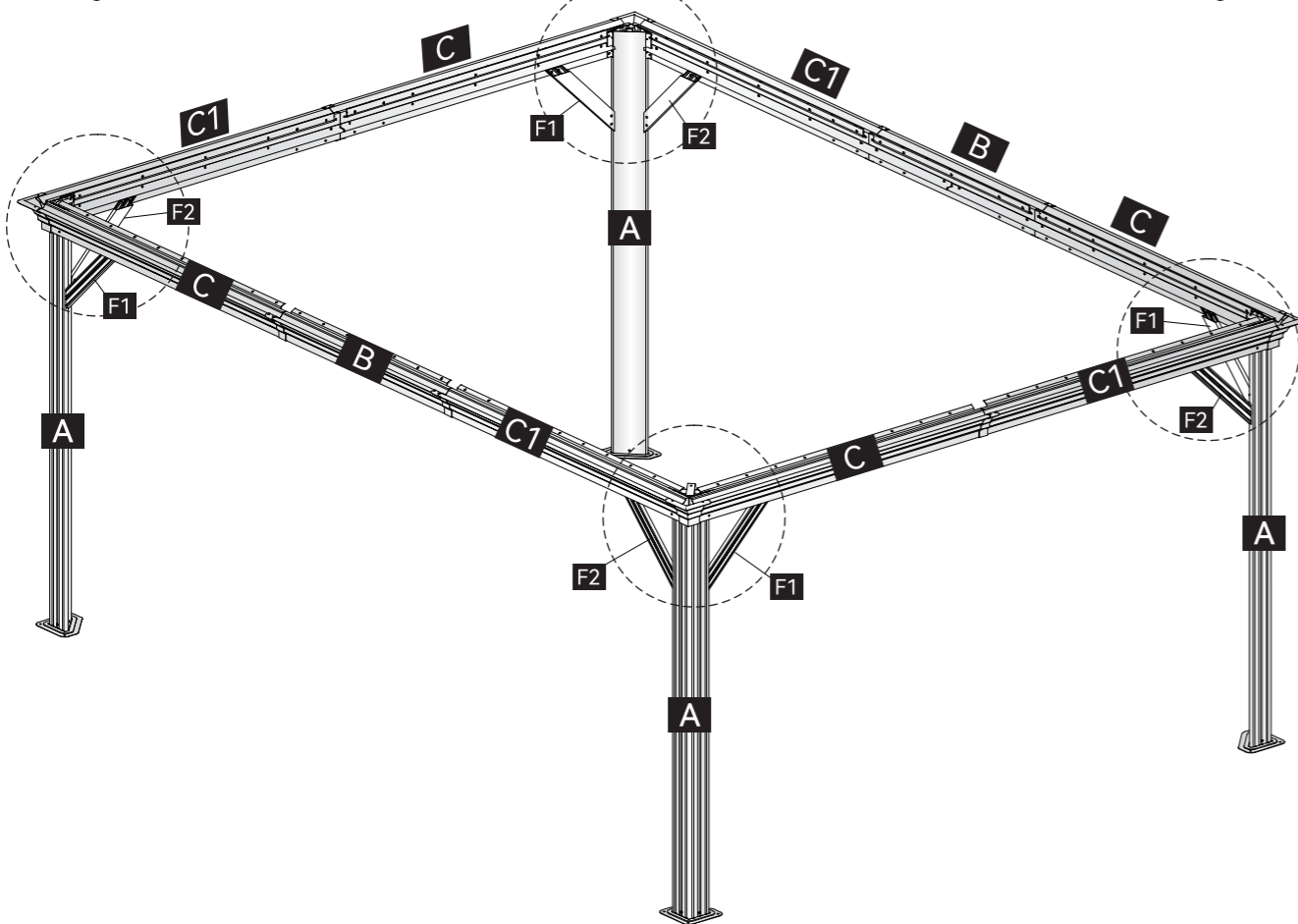
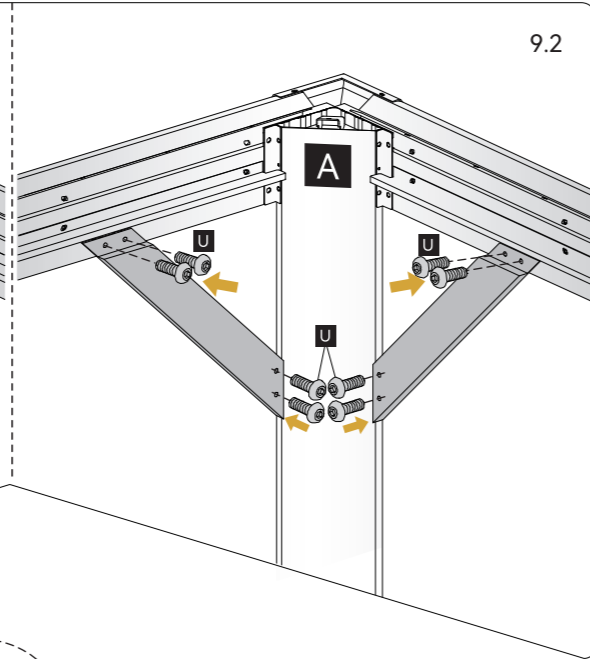

TOP FRAME INSTALLATION



G x4

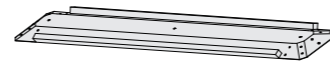

H x1



G1 x4



M6 x 15mm U x8



M6 x 23mm U1 x8

STEP

10

10.1

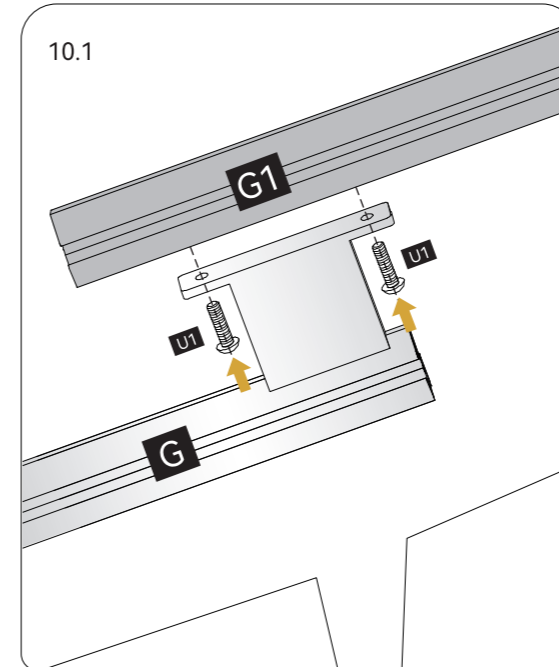

10.2

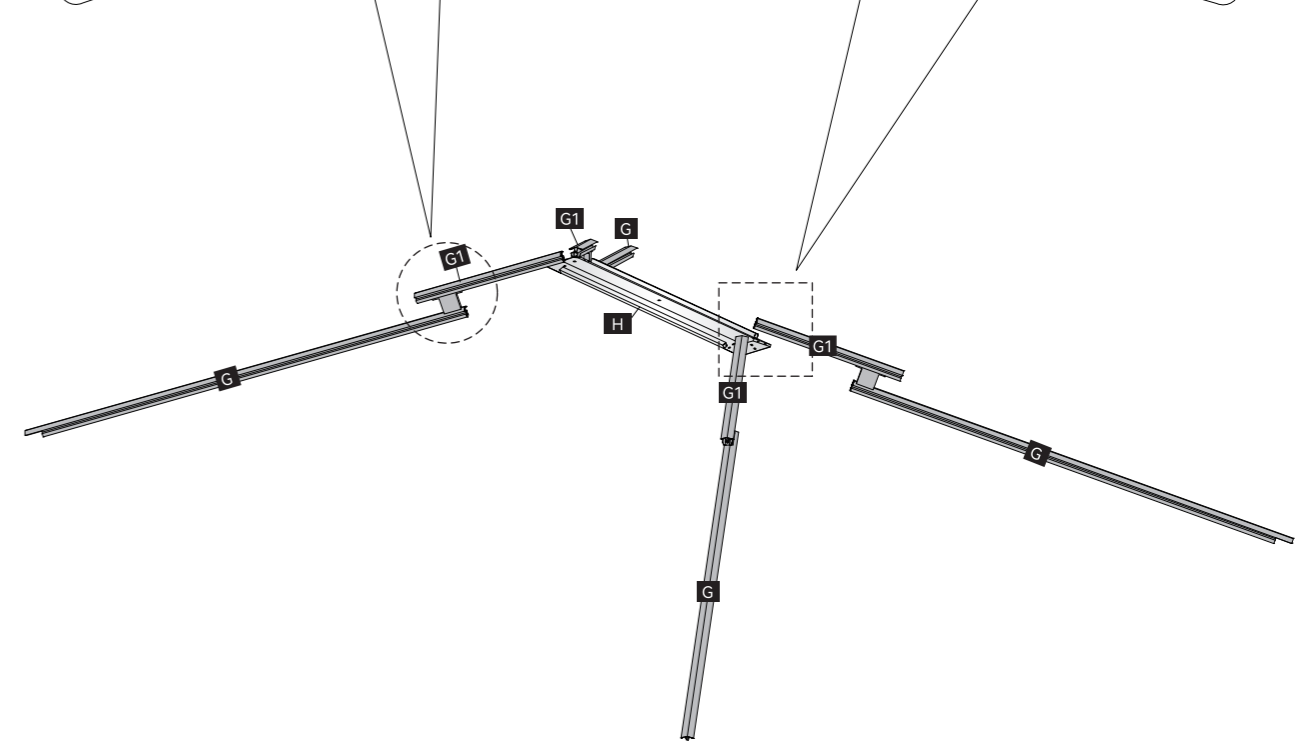
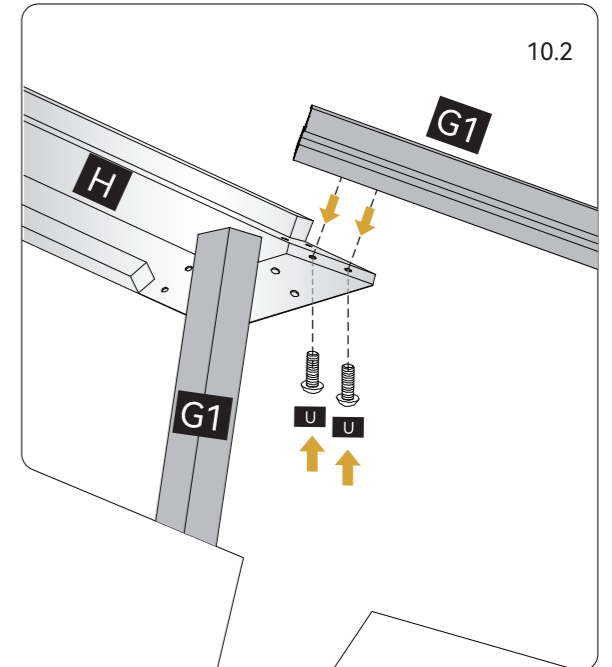

STEP

11

TOP FRAME INSTALLATION



U x4

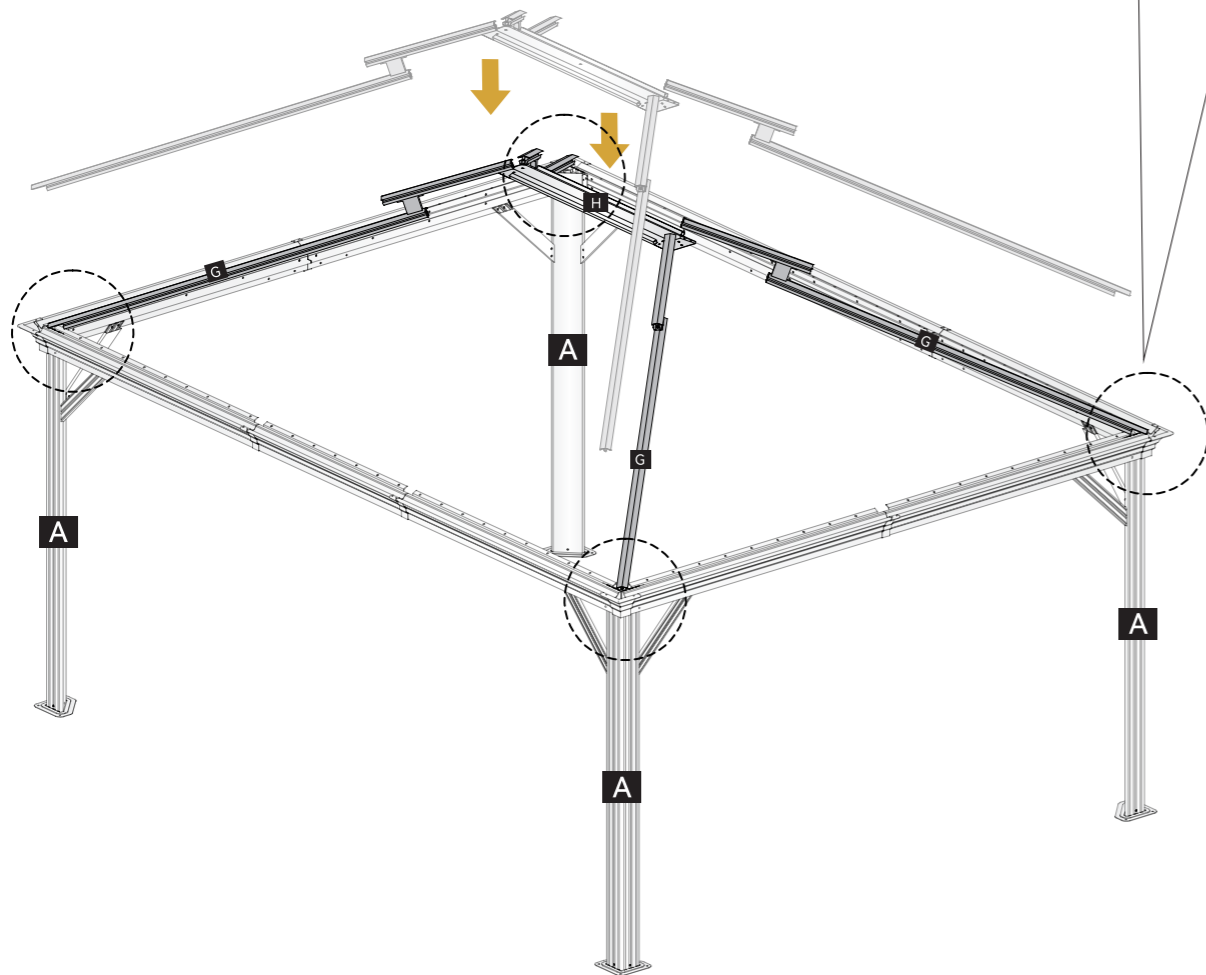
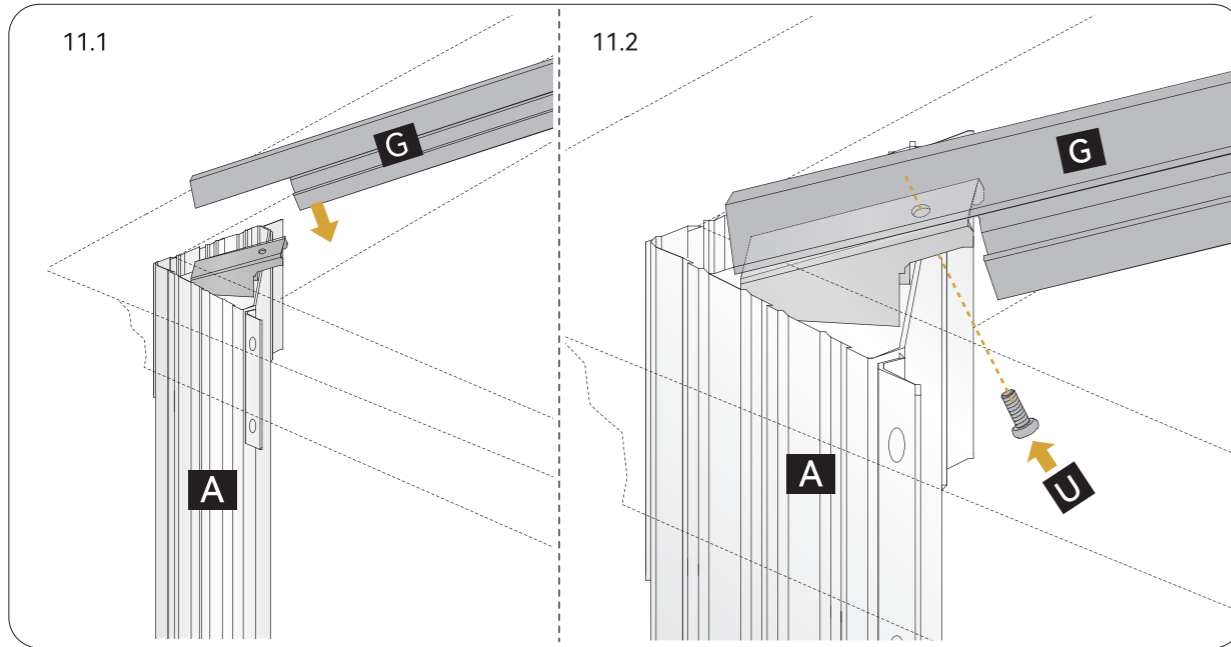

TOP FRAME INSTALLATION

STEP

12

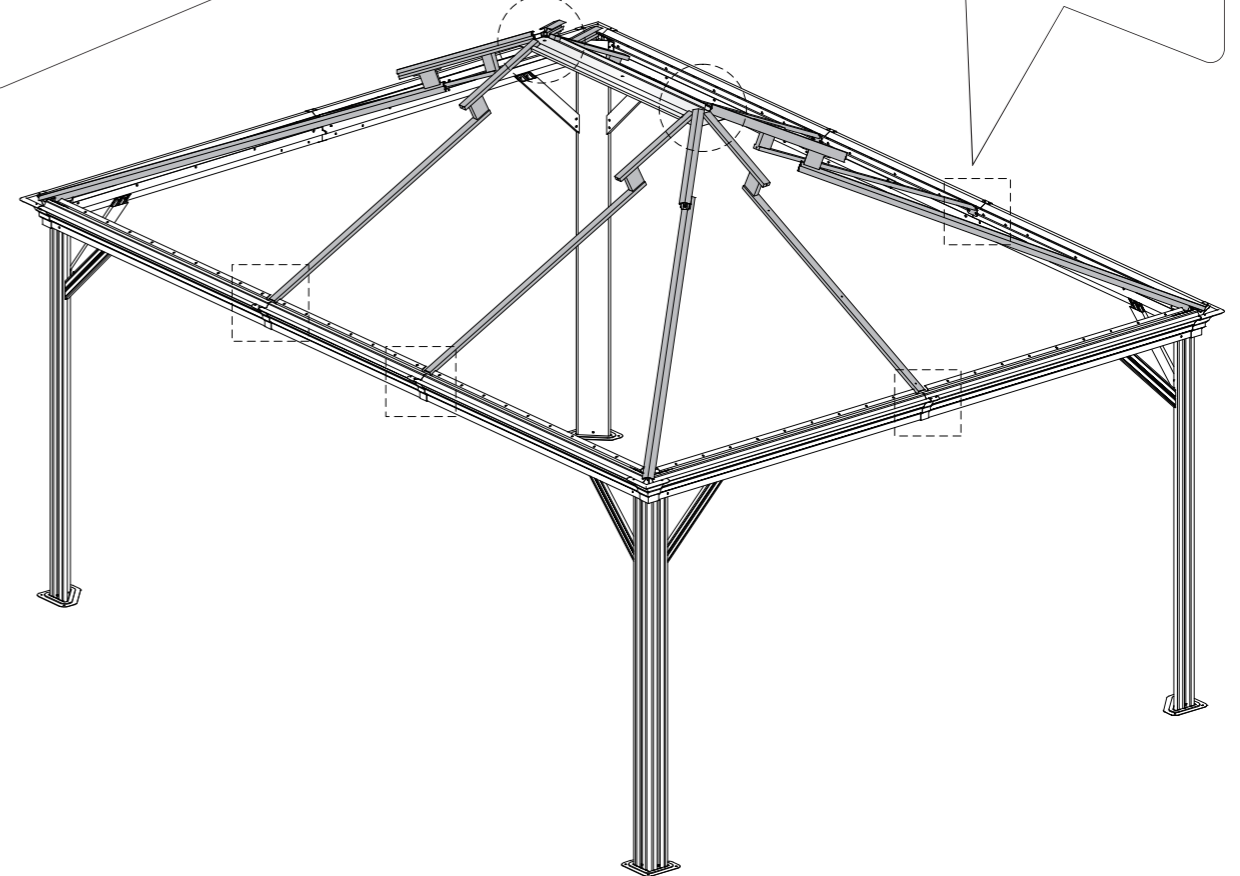
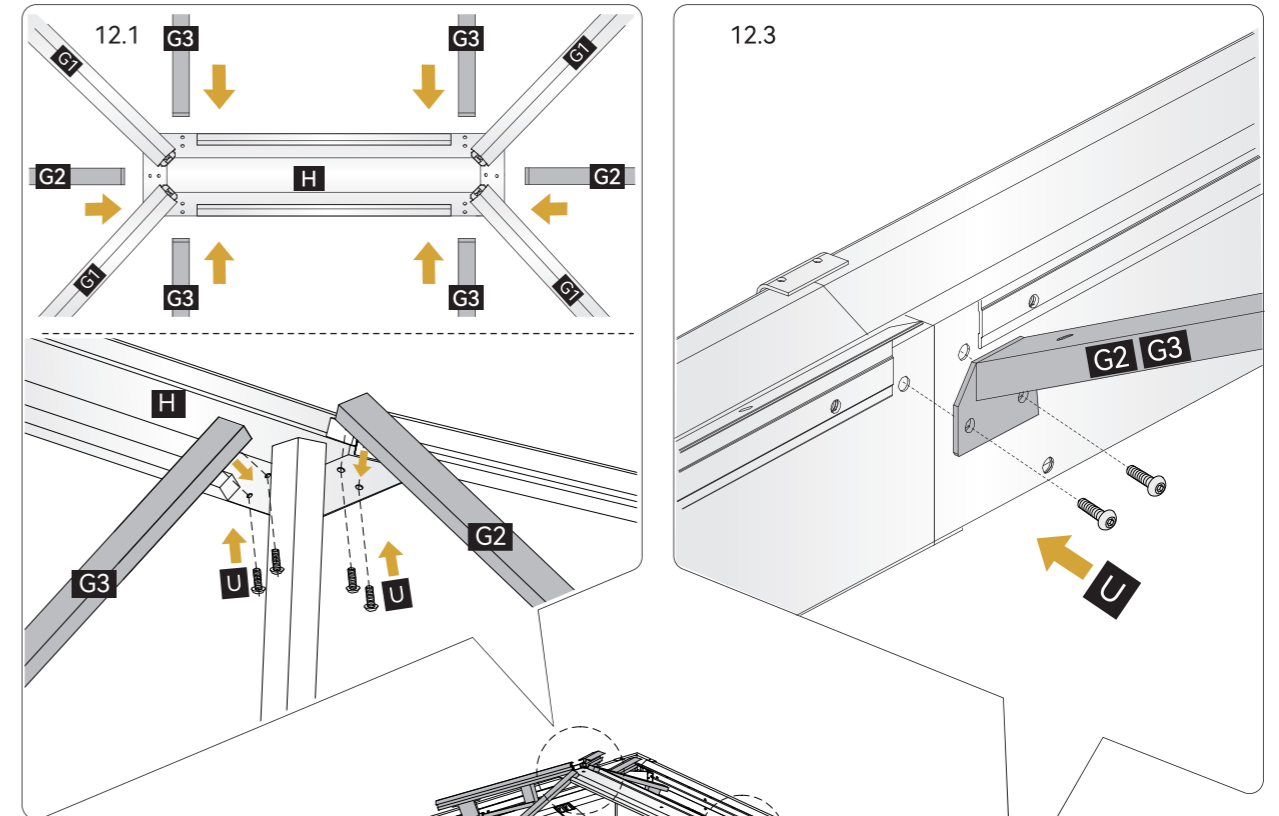
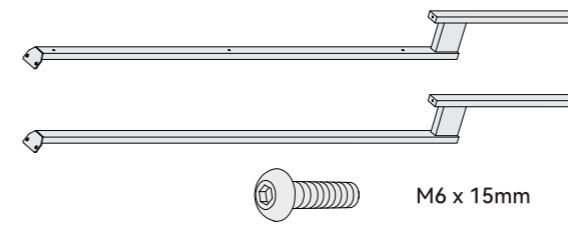

STEP

13

TOP FRAME INSTALLATION

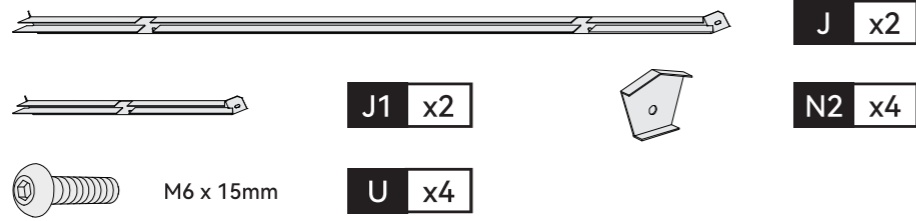

13.1

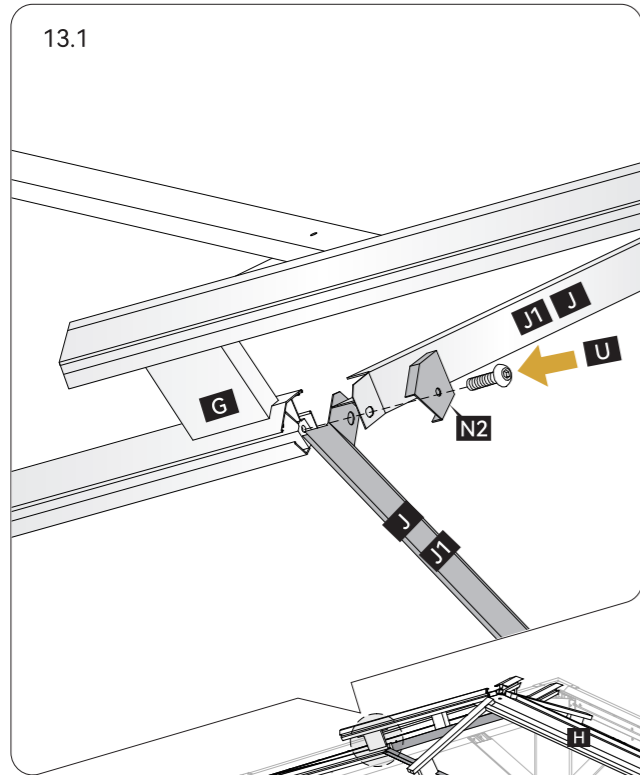

13.2

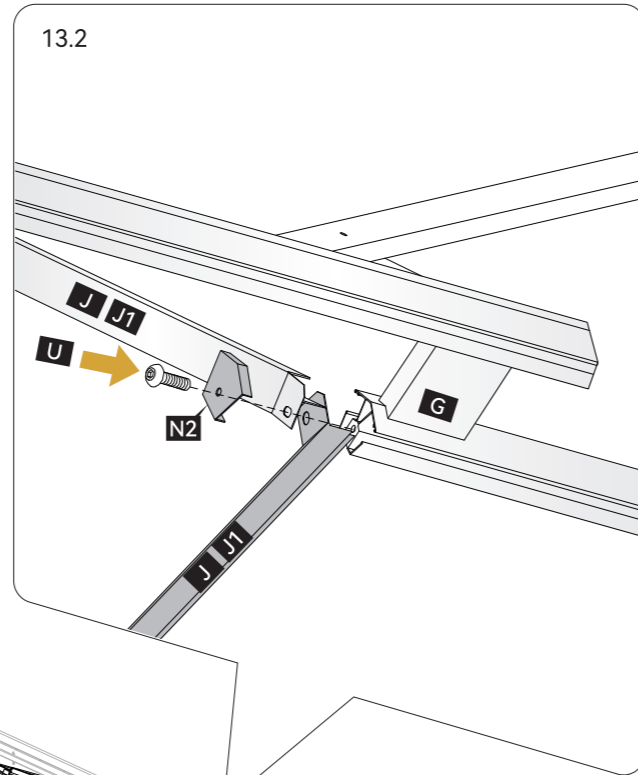

TOP FRAME INSTALLATION

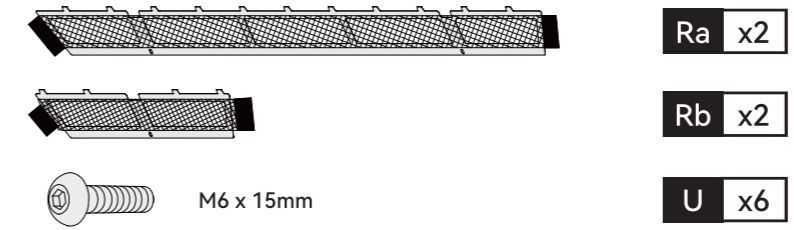

STEP

14

14.1

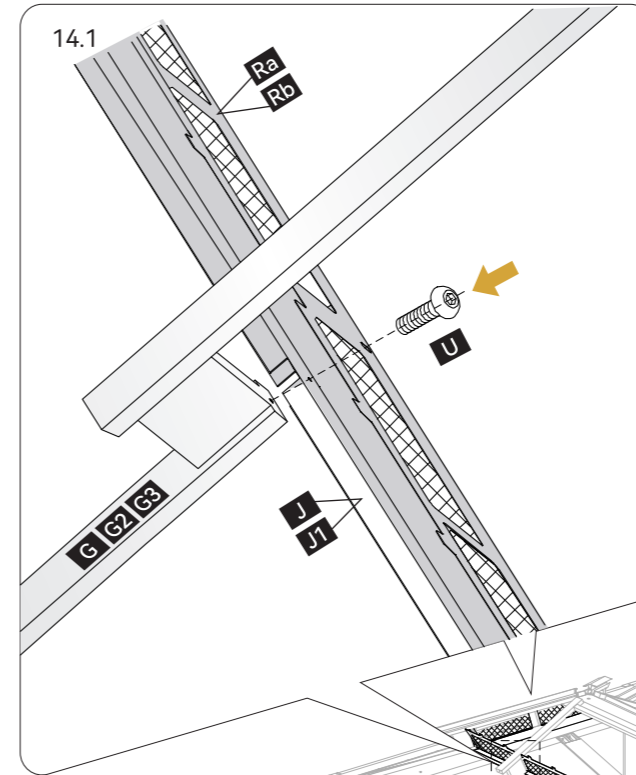

14.2

Velcro sticks together

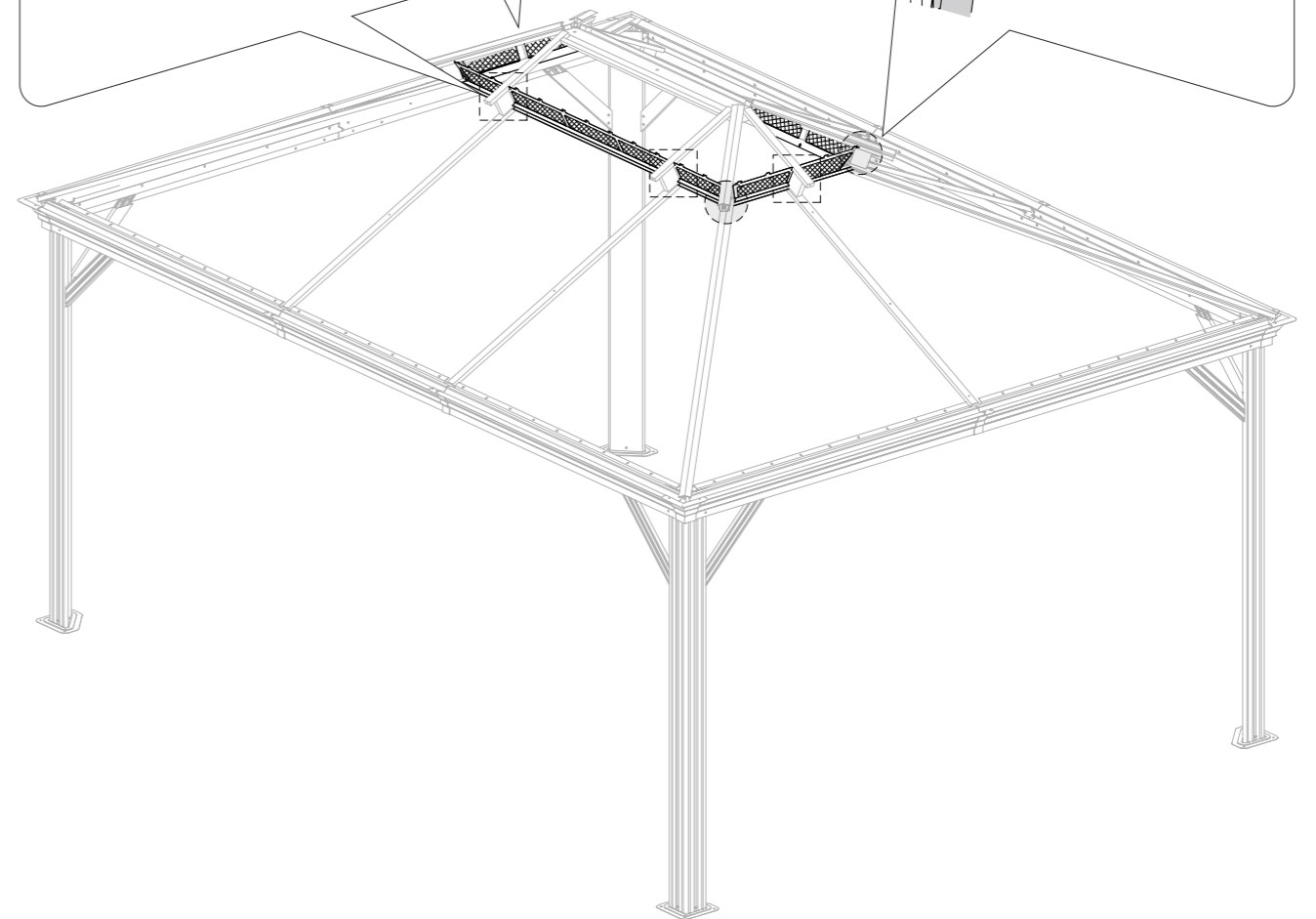
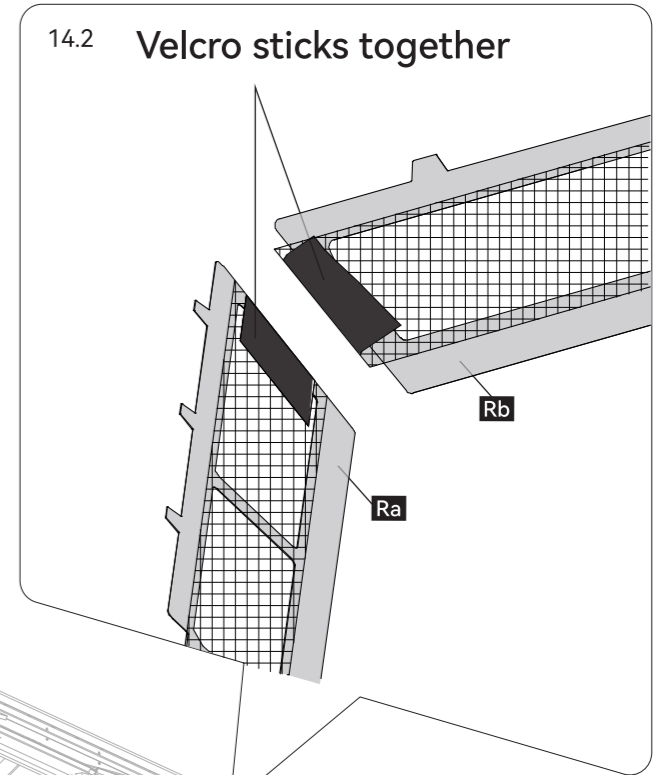

STEP

15

TOP FRAME INSTALLATION

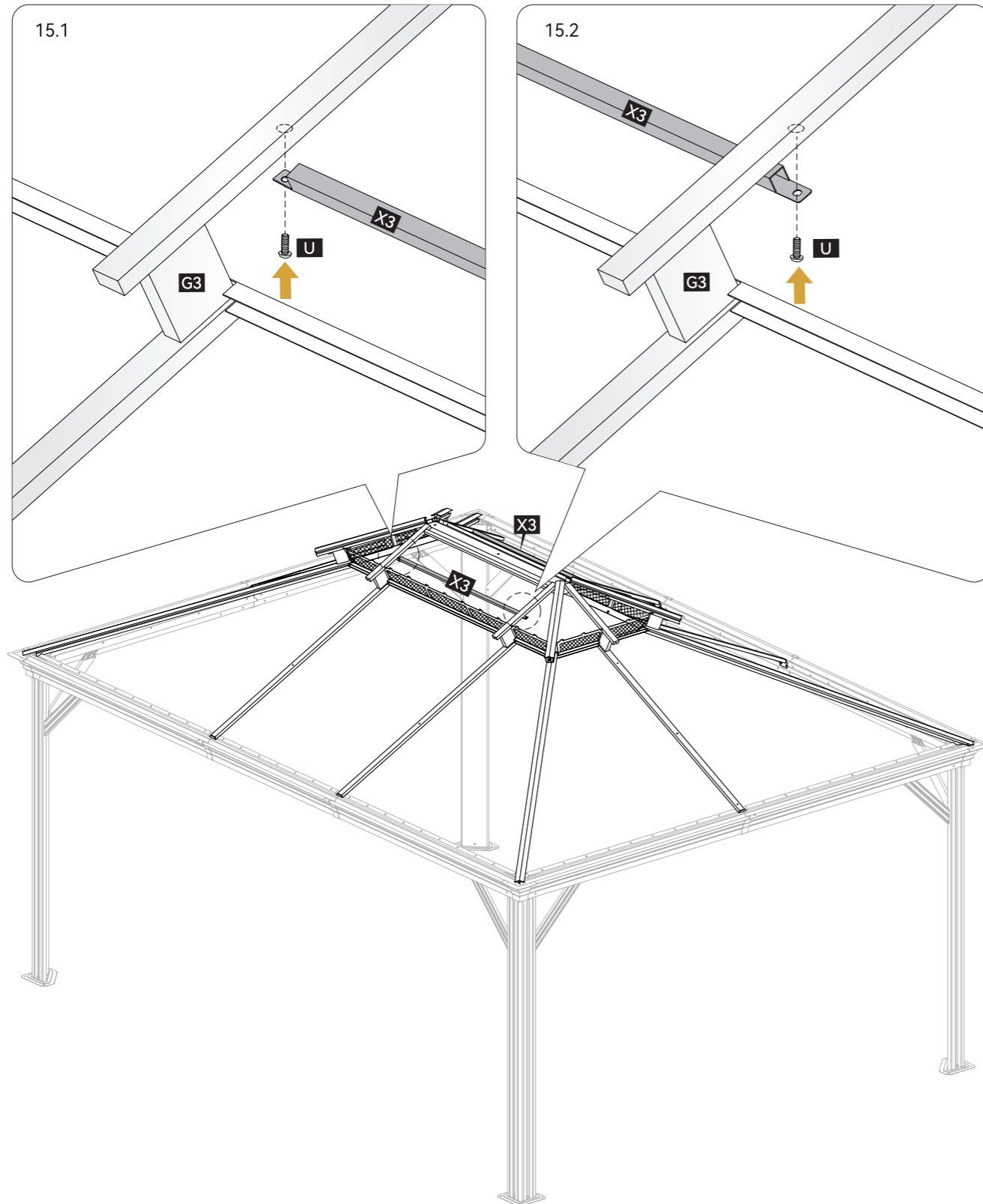
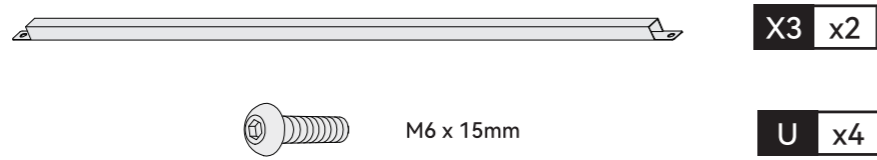

TOP PLATE INSTALLATION

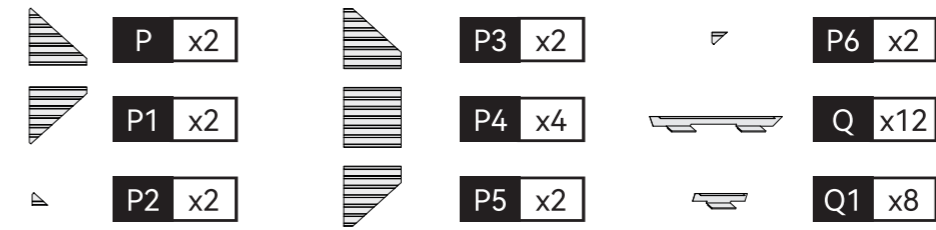

STEP

16

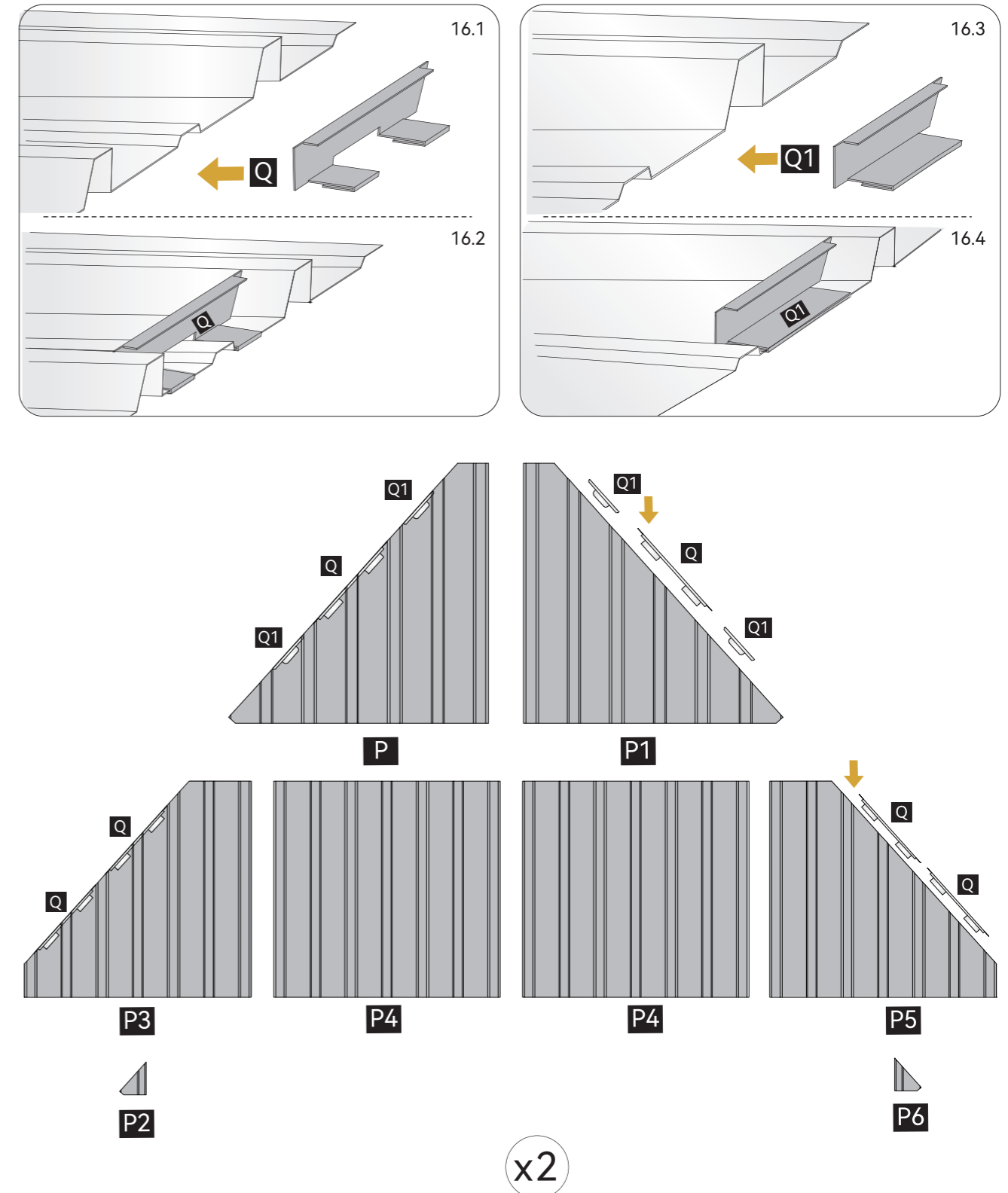

STEP

17

TOP PLATE INSTALLATION

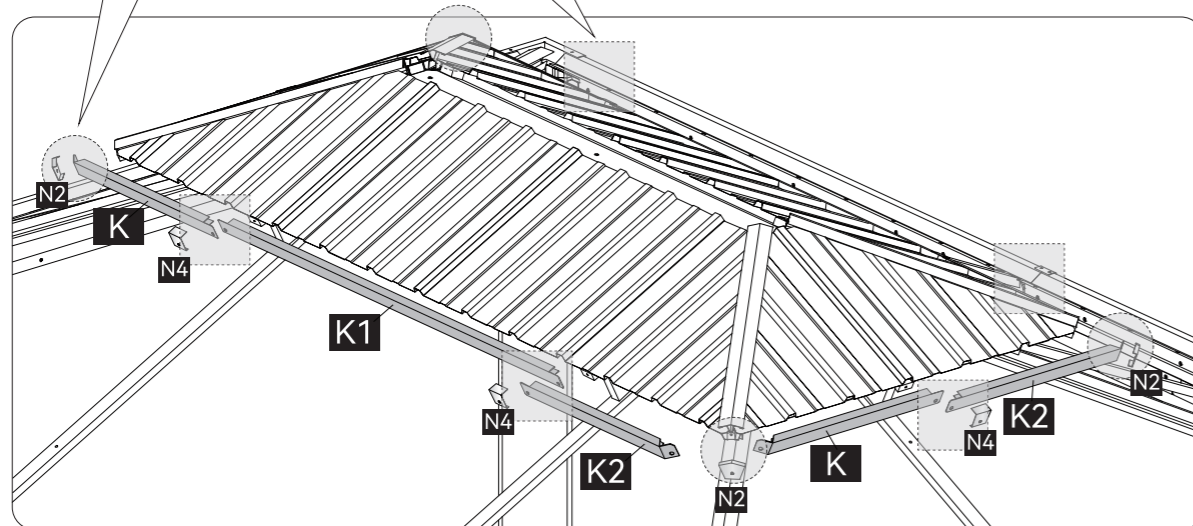
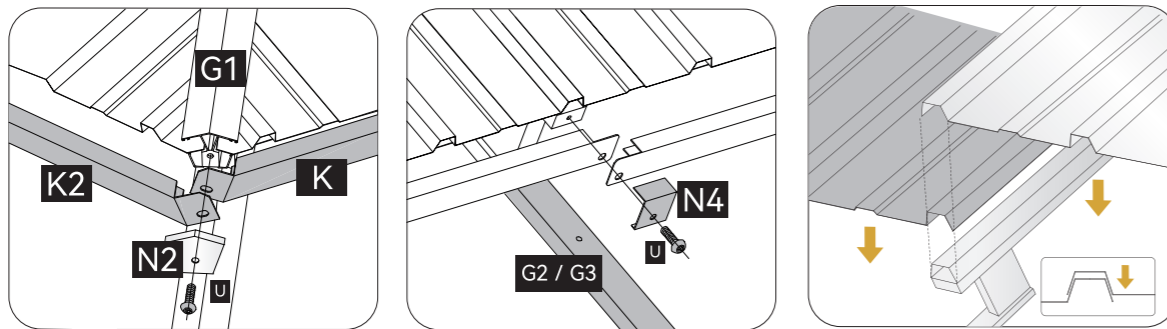
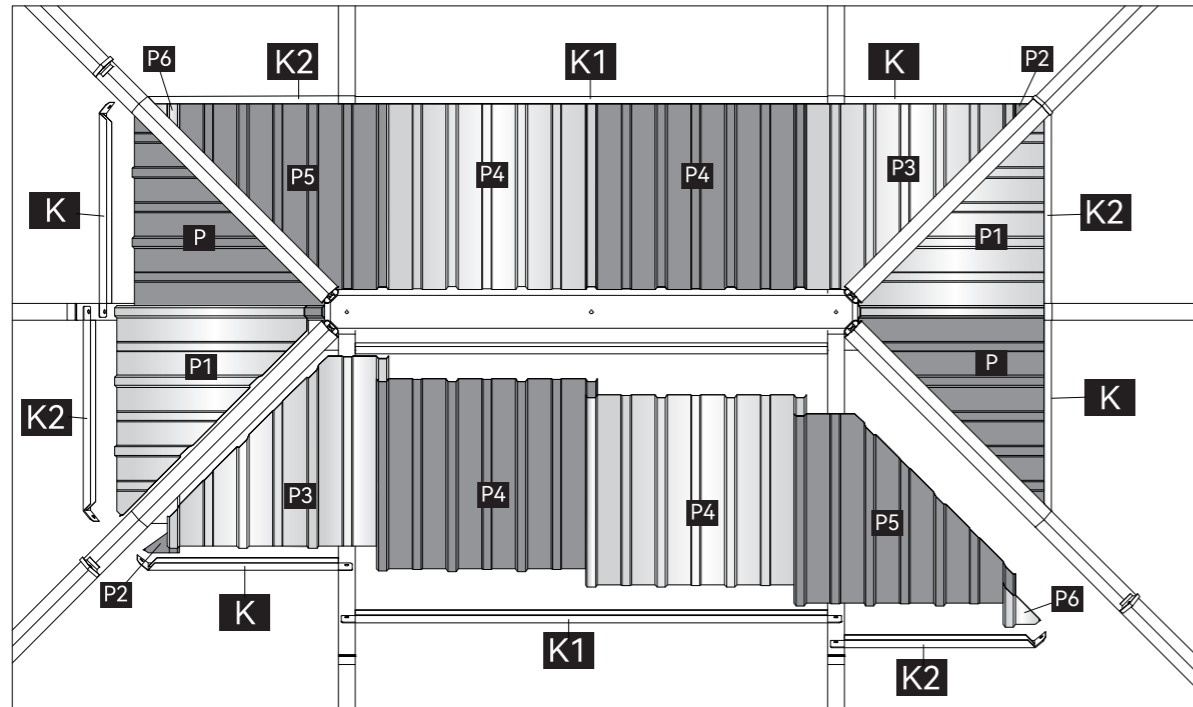
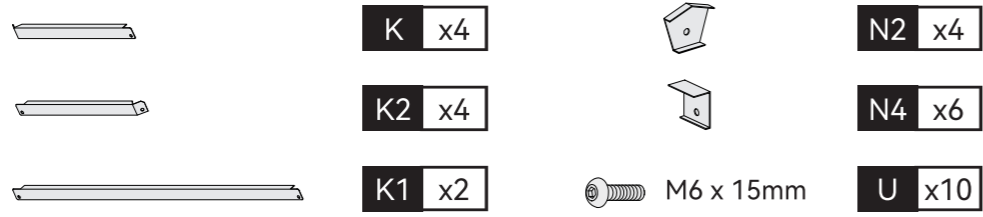

TOP PLATE INSTALLATION

STEP

18

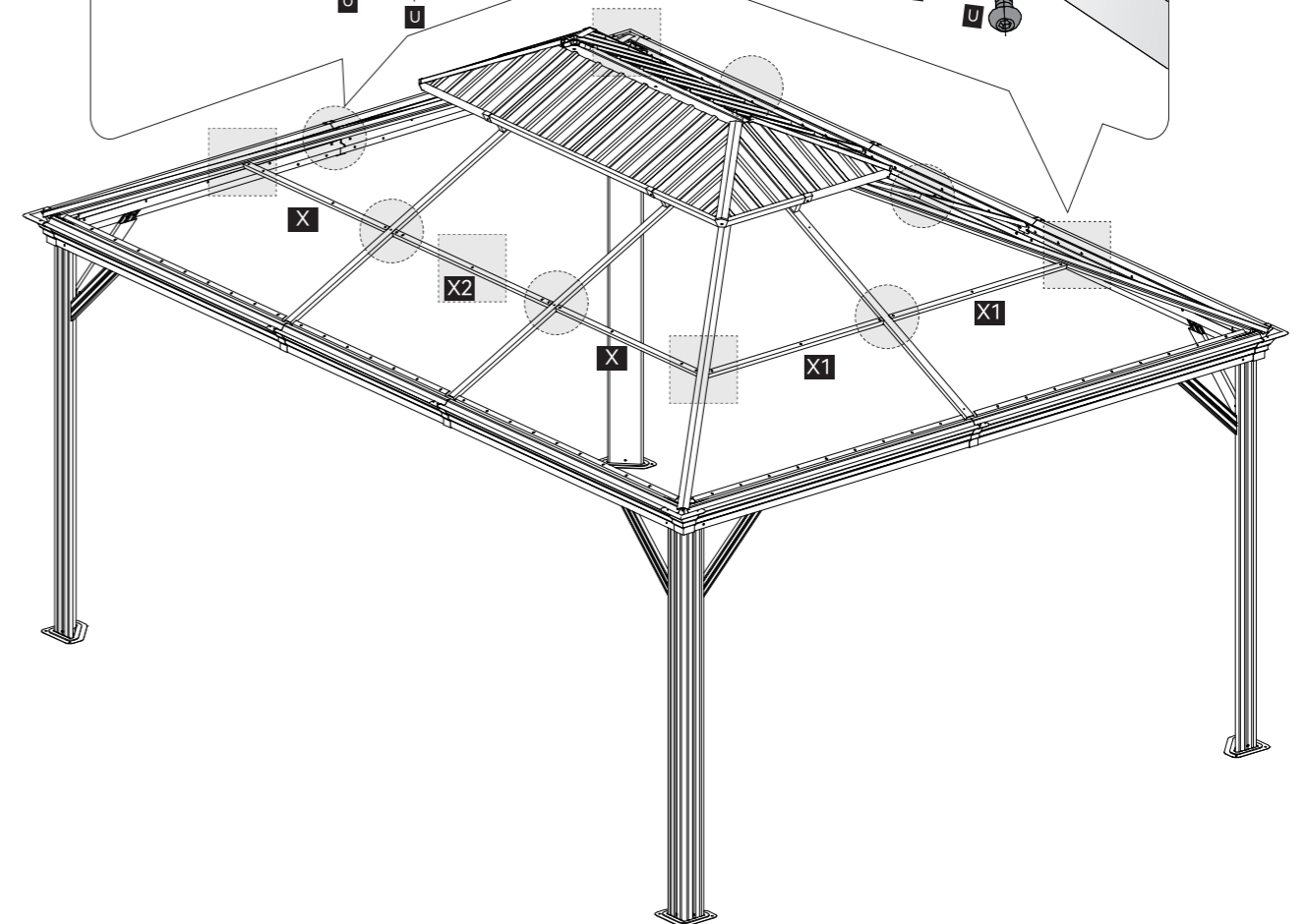
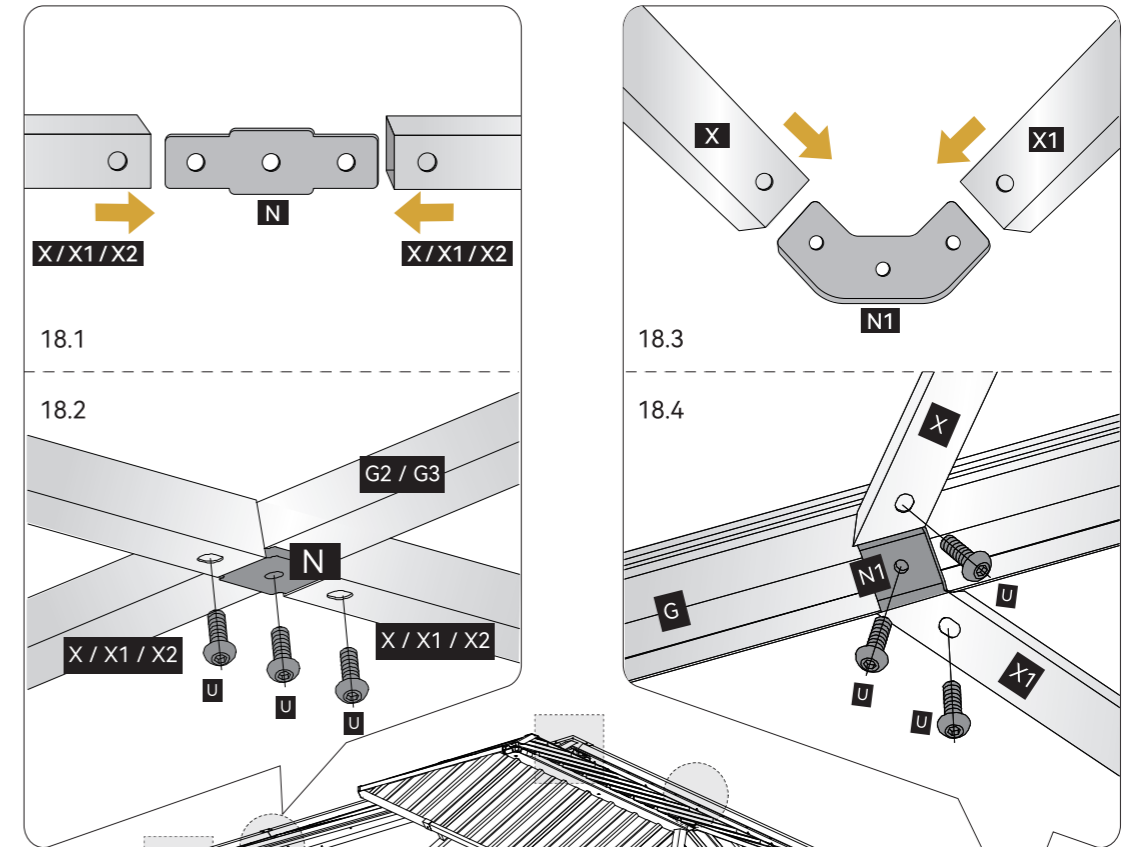
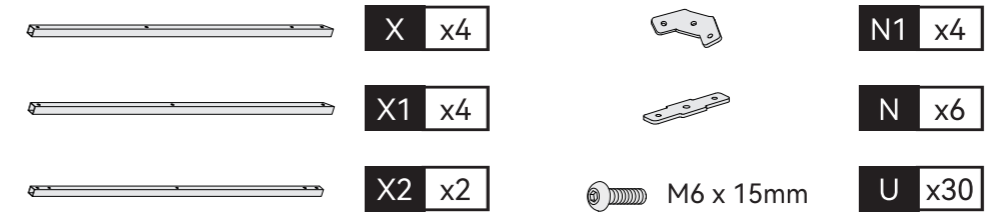

STEP

19

TOP PLATE INSTALLATION

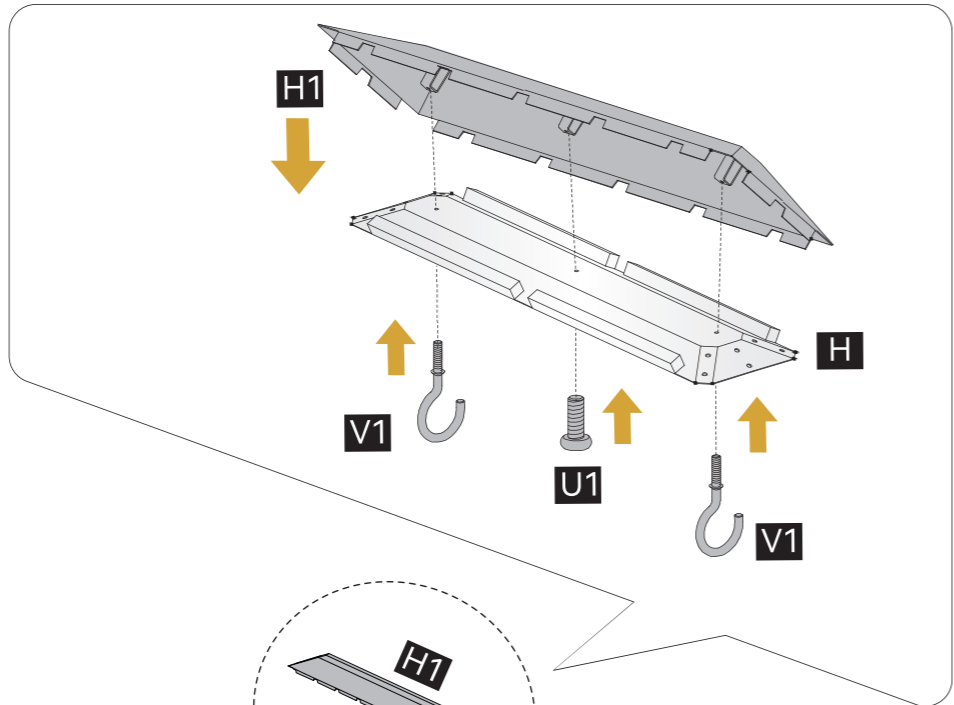
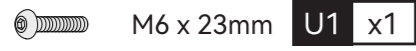
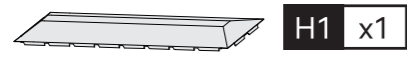

TOP PLATE INSTALLATION



STEP

20

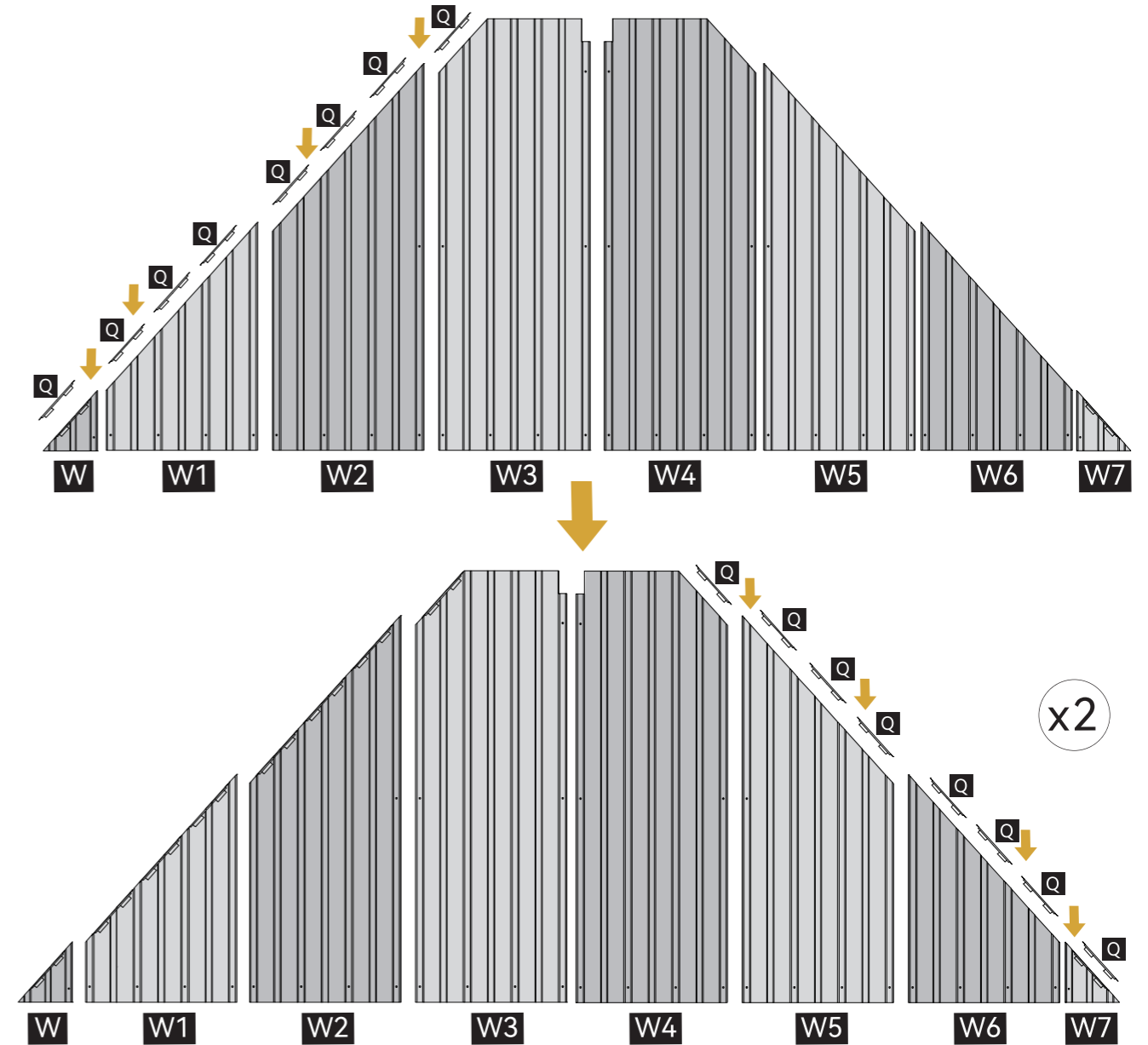
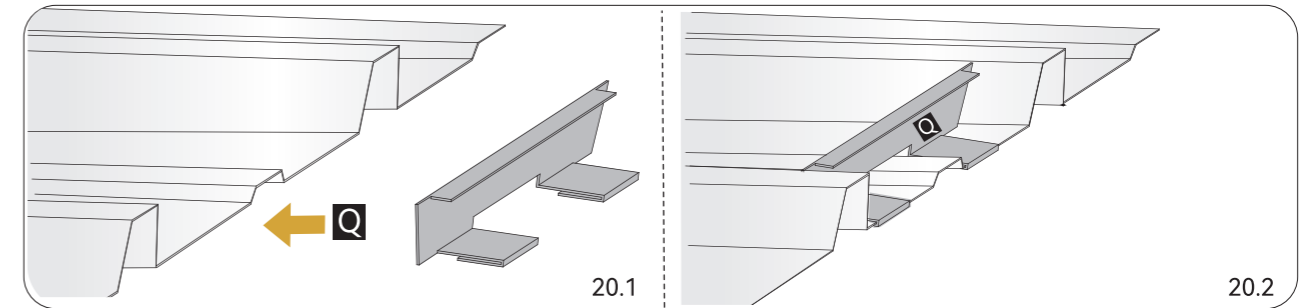

STEP

21

TOP PLATE INSTALLATION

- S x2 S3 x2 S6 x2 Q x28
- S1 x2 S4 x4 S7 x2 Q1 x8
- S2 x2 S5 x2 S8 x2

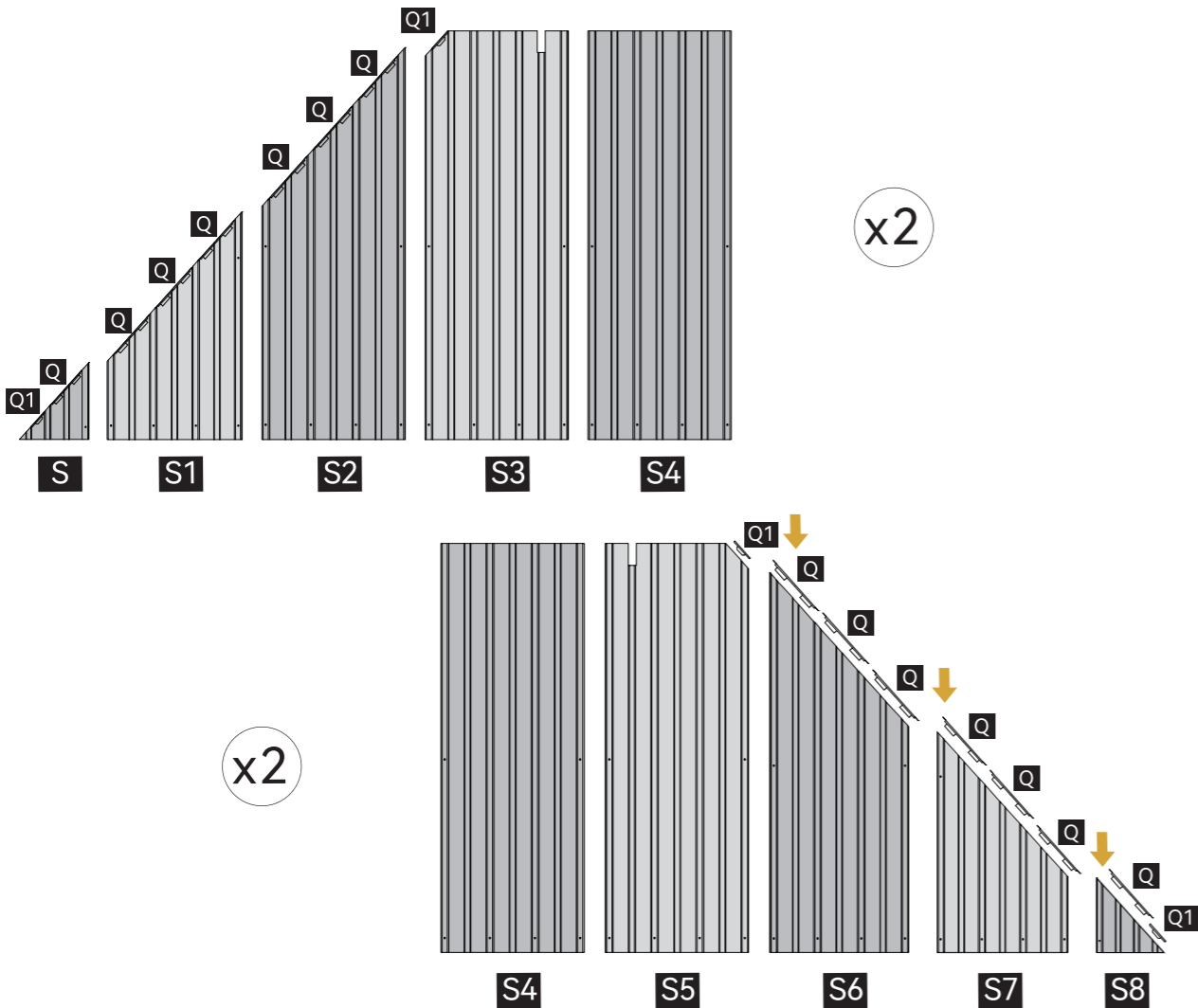
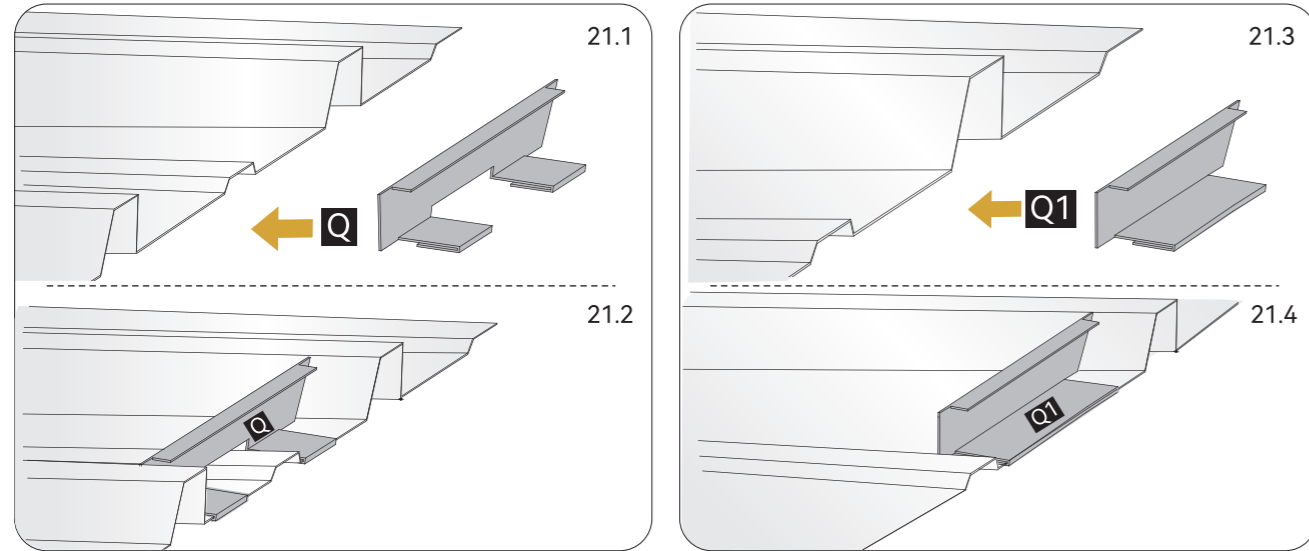

TOP PLATE INSTALLATION

STEP



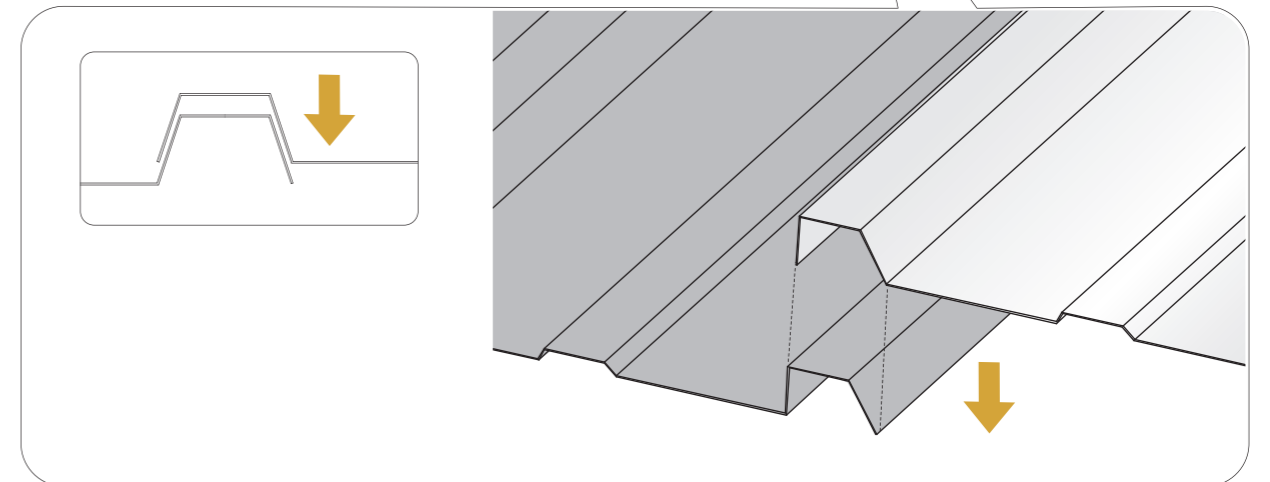
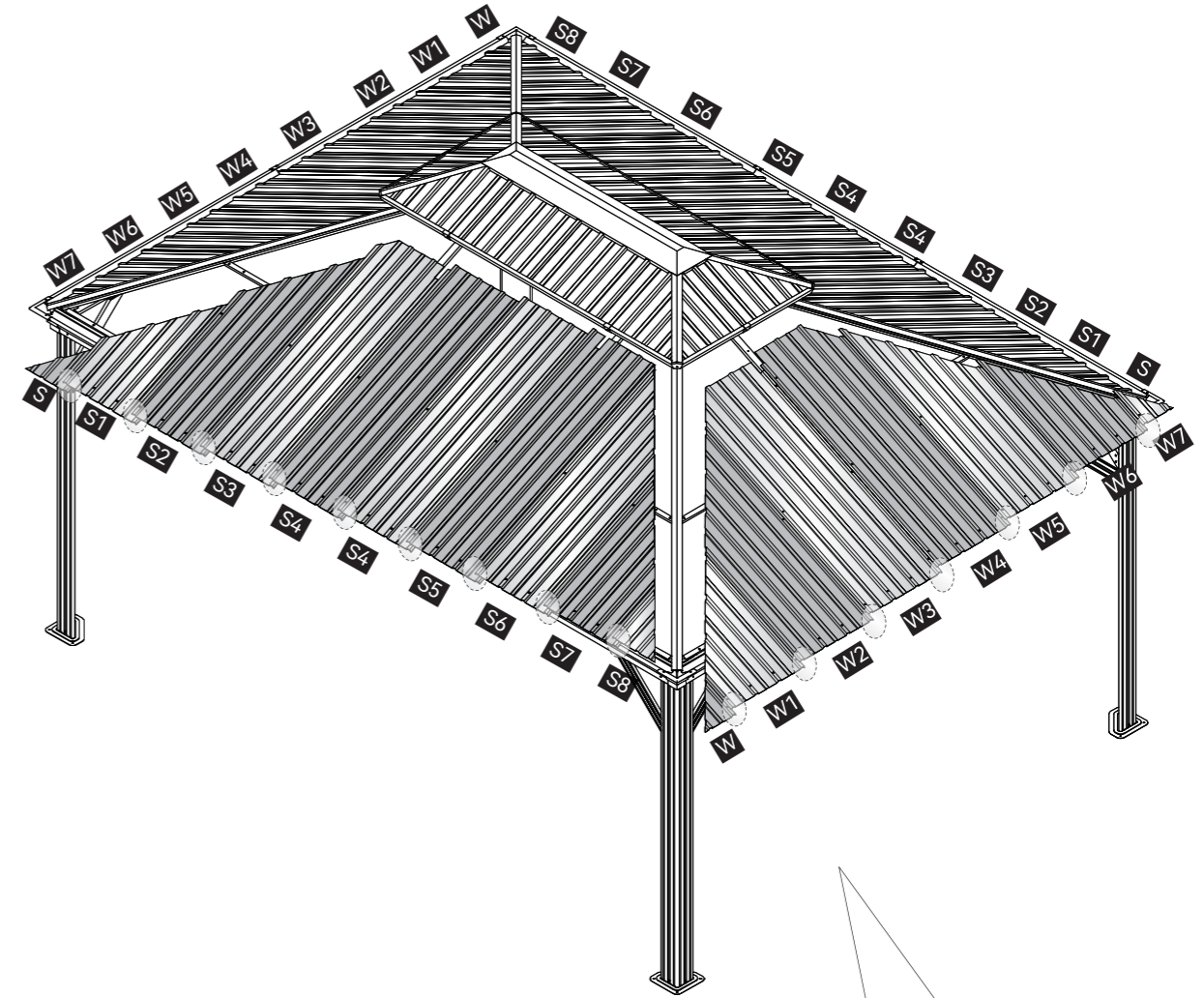

22



STEP

23

TOP PLATE INSTALLATION

-  M6 x 47mm **Z** x18
-  M6 x 42mm **Z1** x4
-  M6 x 23mm **Z2** x86
-  M6 x 23mm **U1** x2
-  **N3** x110

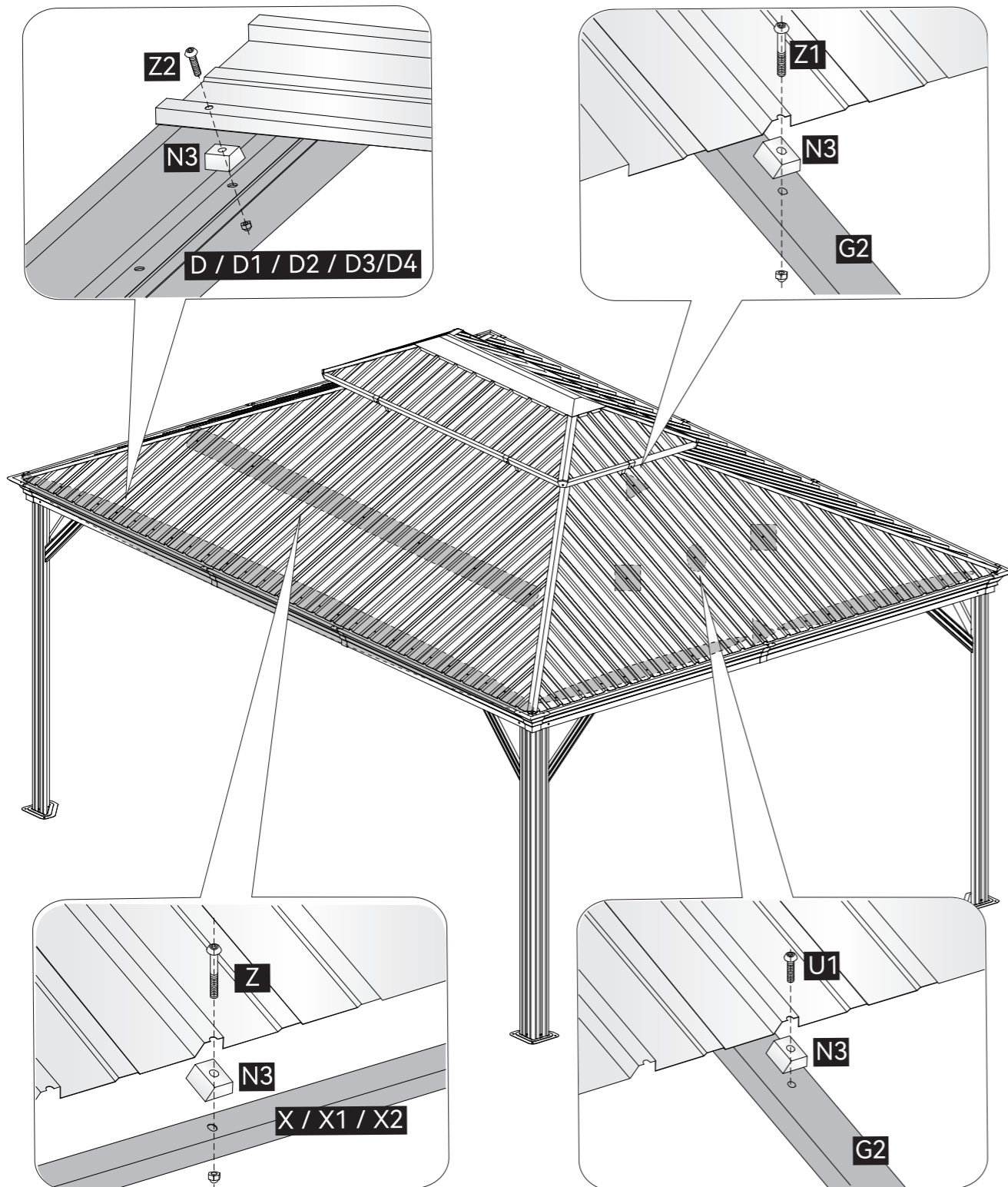

ACCESSORY INSTALLATION

STEP

24

-  **R1** x4
-  **R2** x4

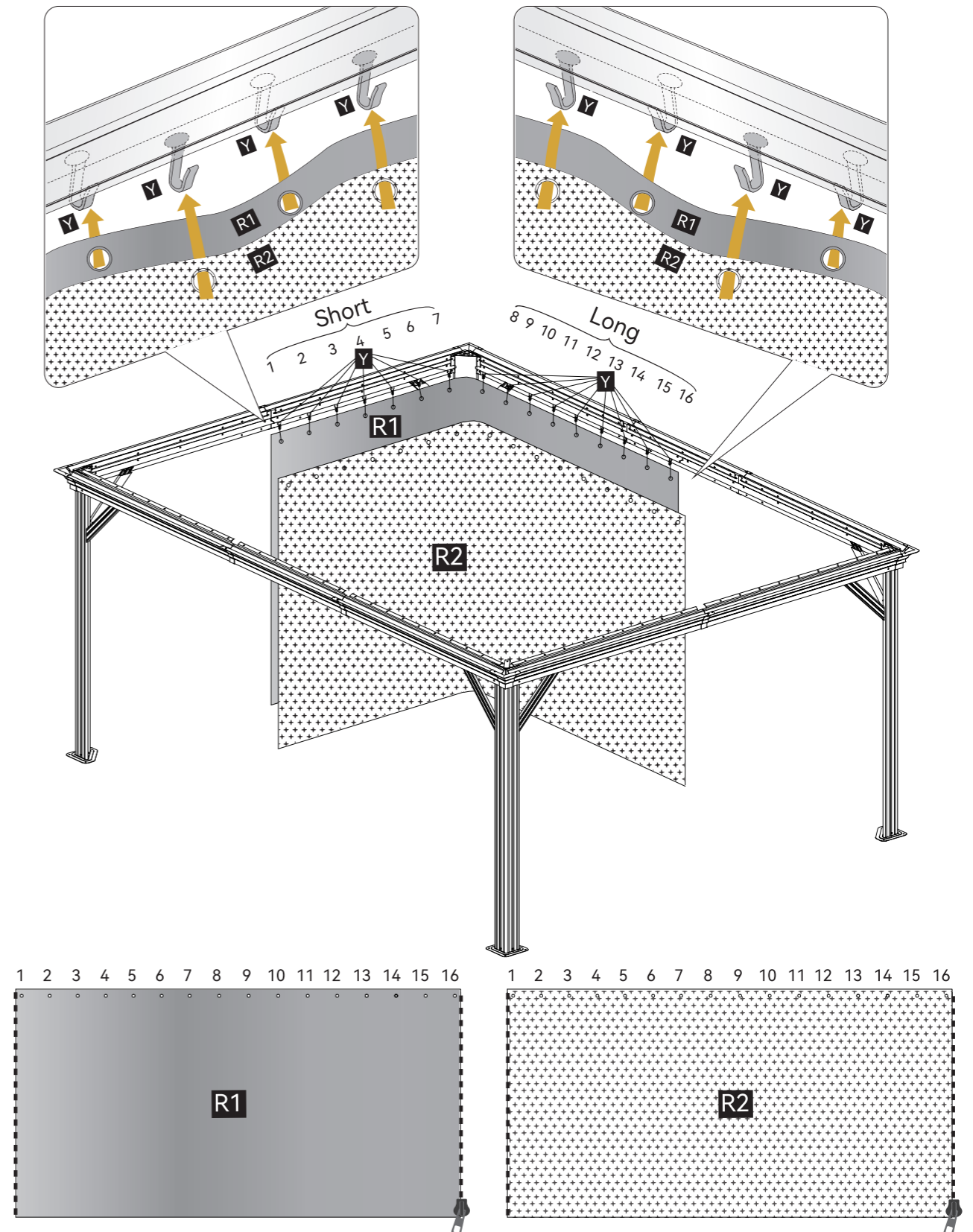

STEP

25

ACCESSORY INSTALLATION

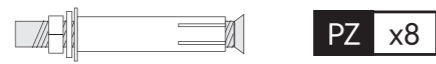

Install On
Hard Floor

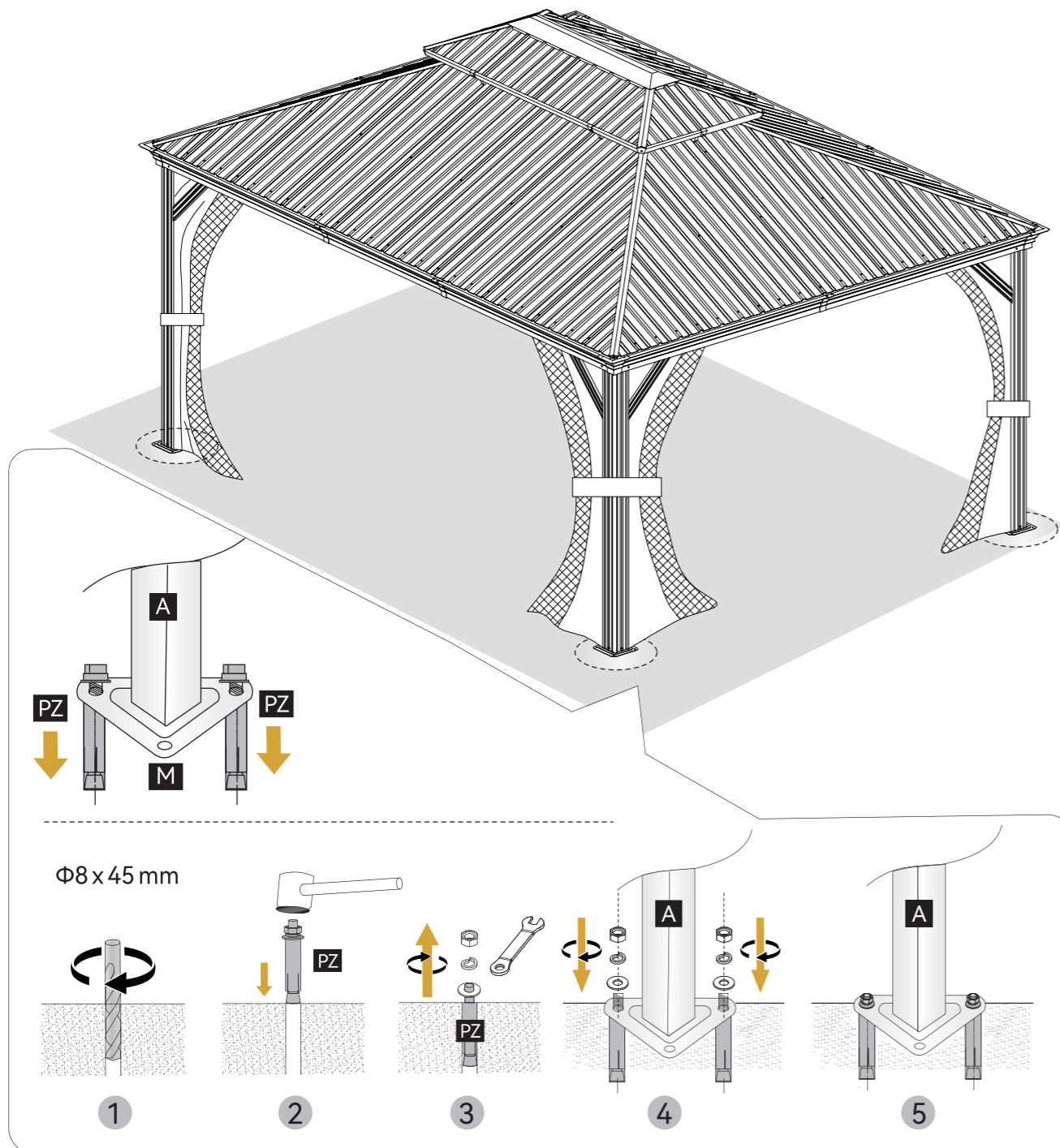

ACCESSORY INSTALLATION



Install On
Lawn

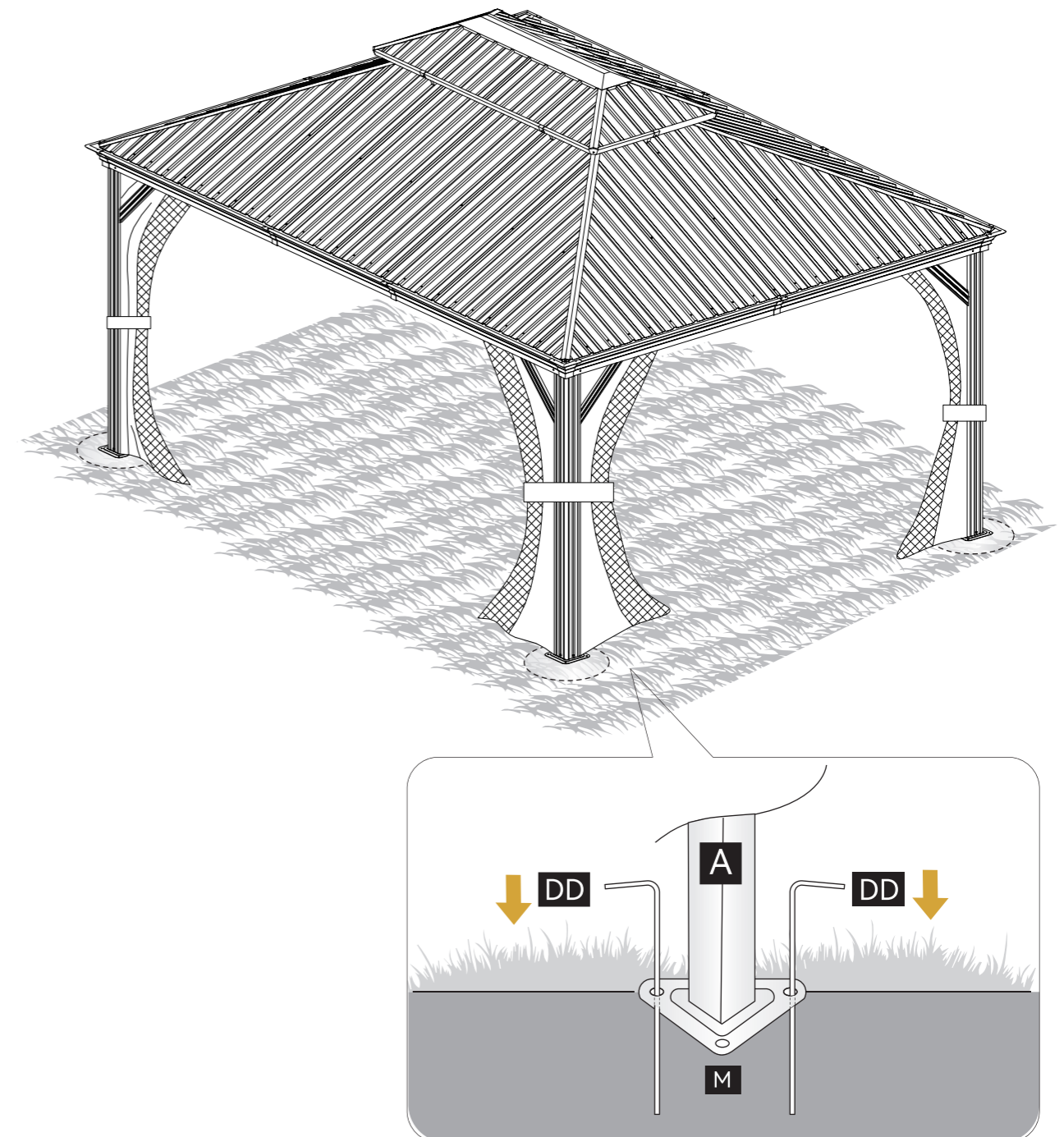

STEP

26