

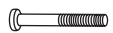

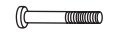

① x36		Ⓐ x10		
② x9		Ⓑ x4		
③ x35		Ⓒ x4		
④ x20		Ⓓ x1		
⑤ x7		Ⓗ x45		M6x $\frac{52}{2.0}$
⑥ x4		Ⓗ1 x66		M6x $\frac{30}{1.2}$
⑦ x4		Ⓚ x111		
⑧ x4		Ⓛ x1		
		Ⓜ x1		

1

	(H) x18
	(H1) x24
	(K) x42

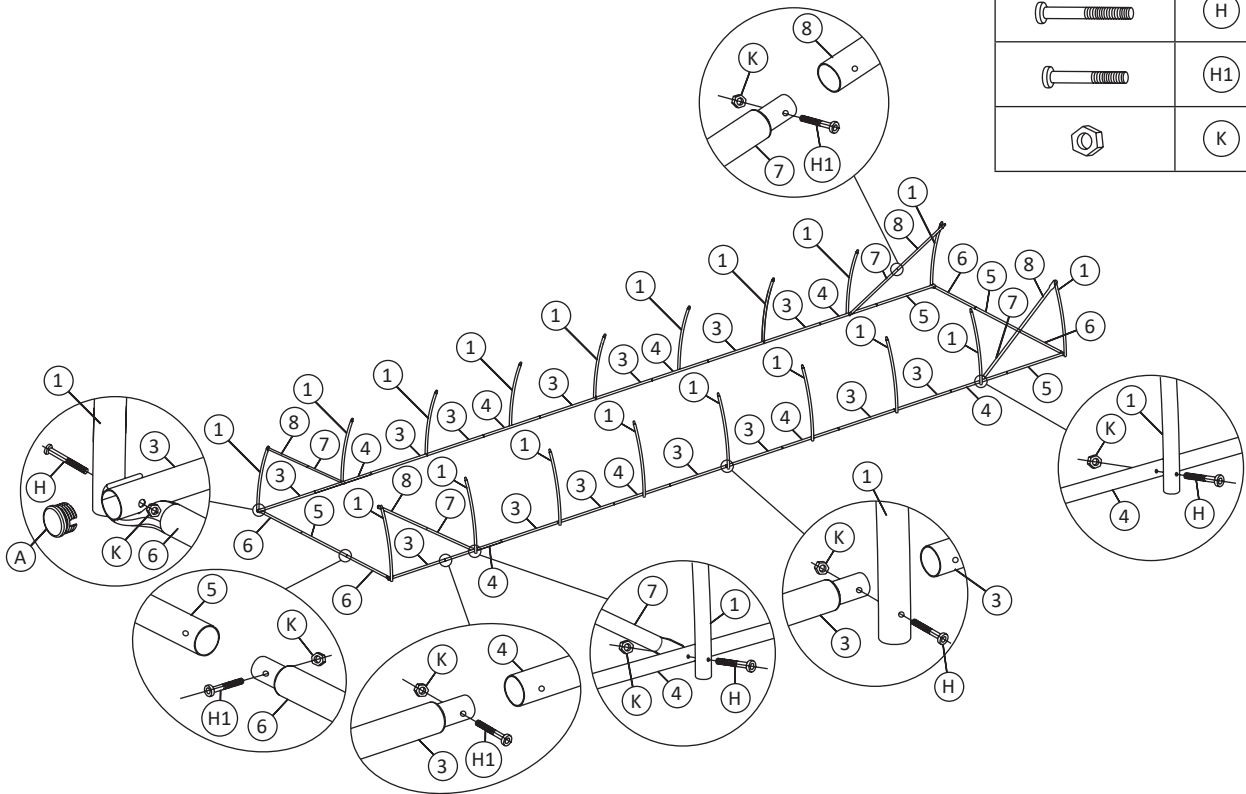

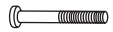
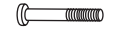
2

	(H) x6
	(H1) x7
	(K) x13

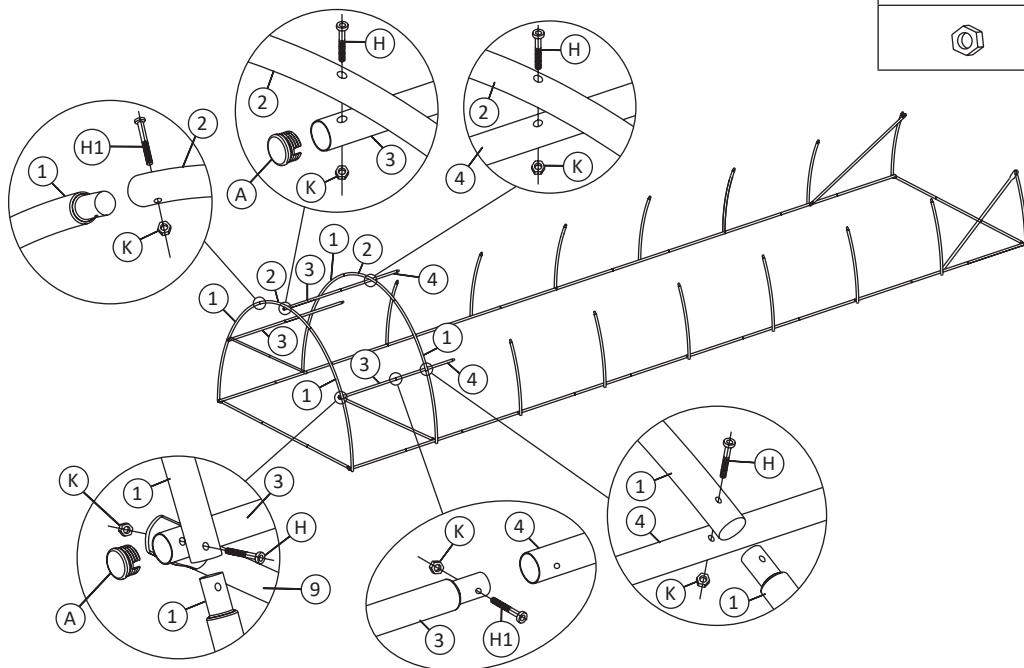

3

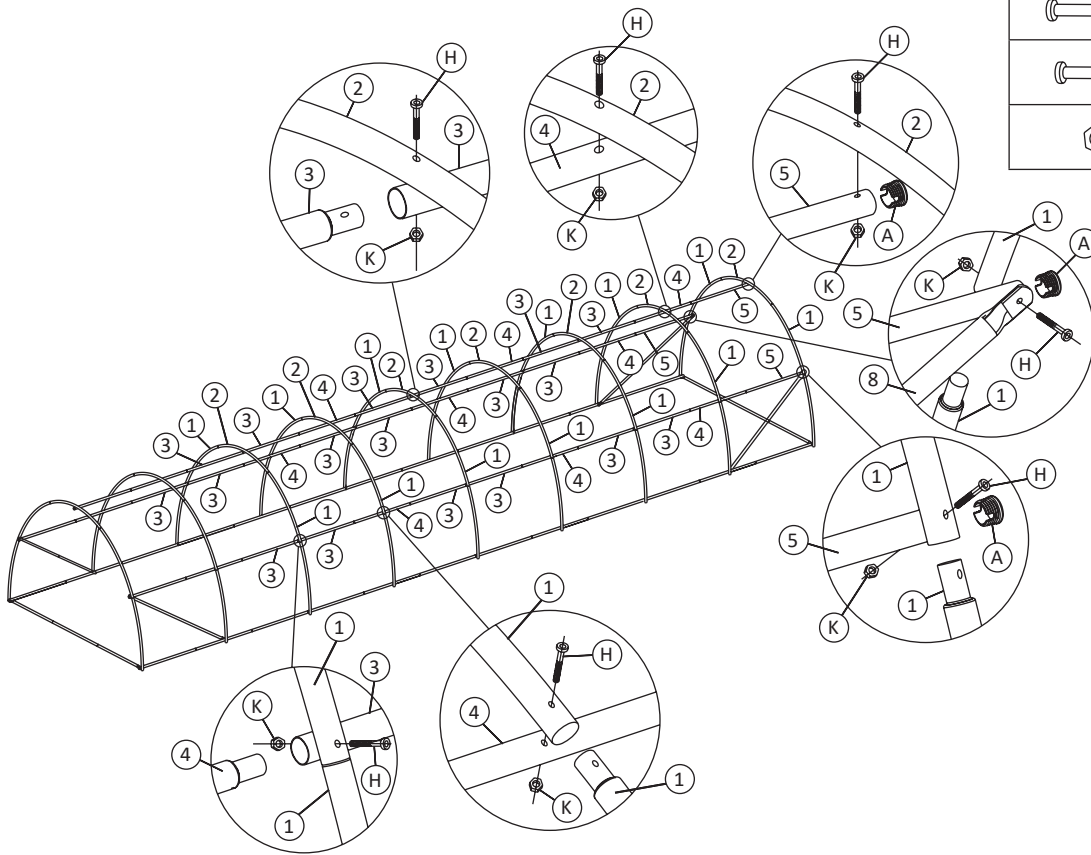

	Ⓜ H x21
	Ⓜ H1 x35
	Ⓜ K x56

4

