

Top View

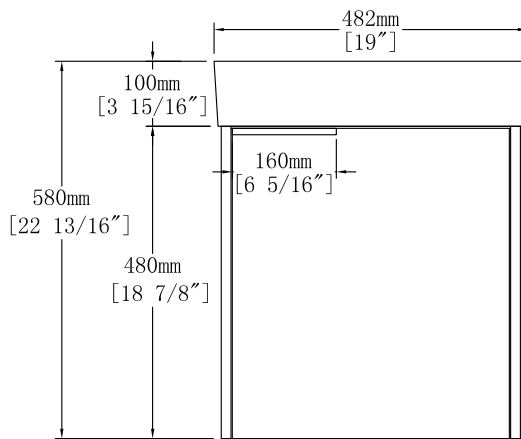

Front View

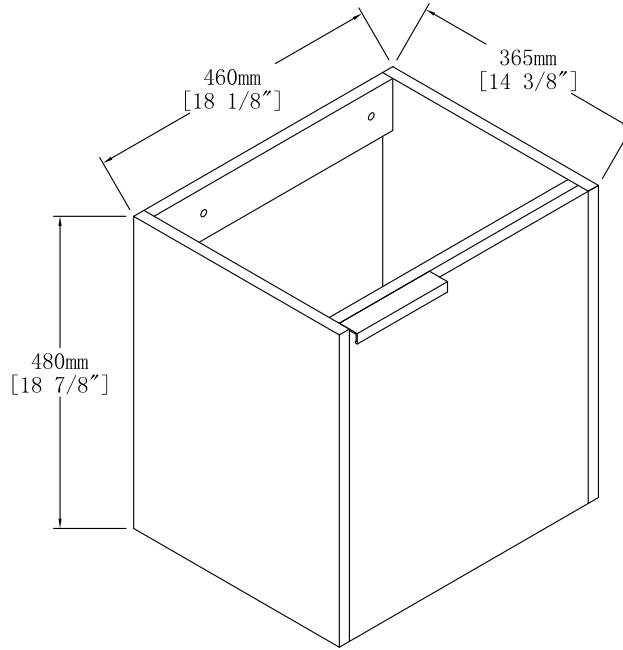
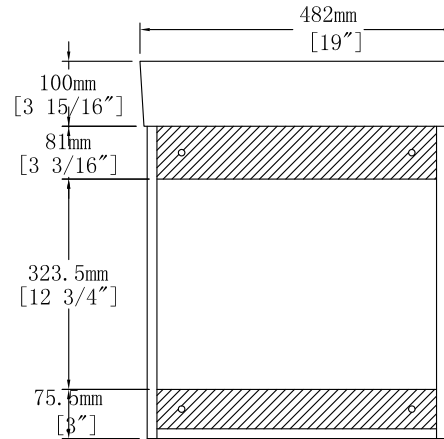

Back View

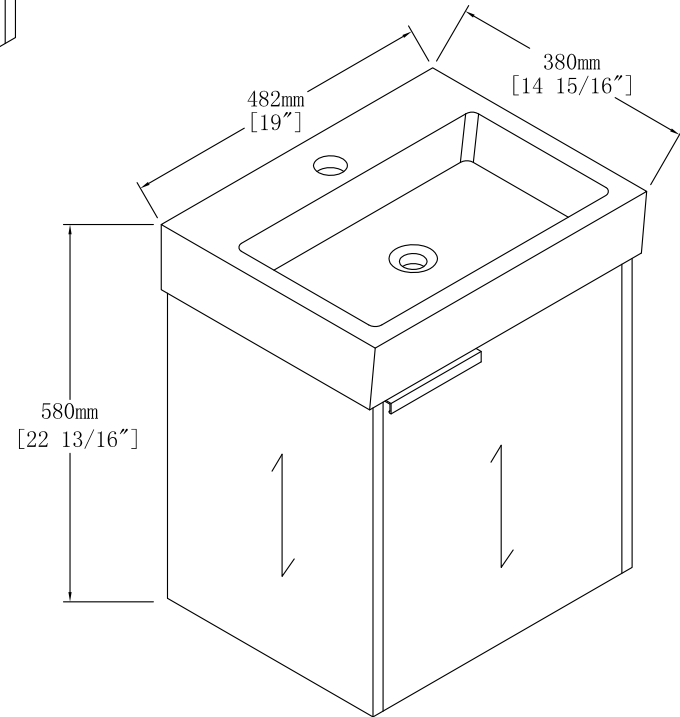

	Item NO.	BV C01518	Version	V1
	Projece		Date	2022-3-25