











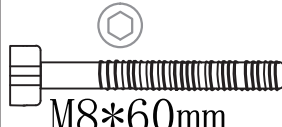

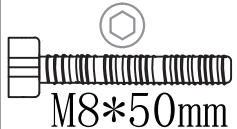



# ASSEMBLY INSTRUCTIONS

A		X 1PC	J		X 2PCS
B		X 1PC	K	 M8*60mm	X 4PCS
C		X 1PC	L	 M8*50mm	X 4PCS
D		X 1PC	M	 M8	X 8PCS
E		X 1PC	N	 M8*22mm	X 8PCS
F		X 1PC	O	 5*40mm	X 4PCS
G		X 1PC	P	 M6*25mm	X 4PCS
H		X 1PC	Q	 M8	X 1PC
I		X 1PC	R	 M6	X 1PC

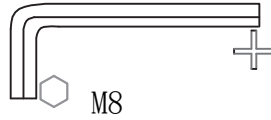

# ASSEMBLY INSTRUCTIONS

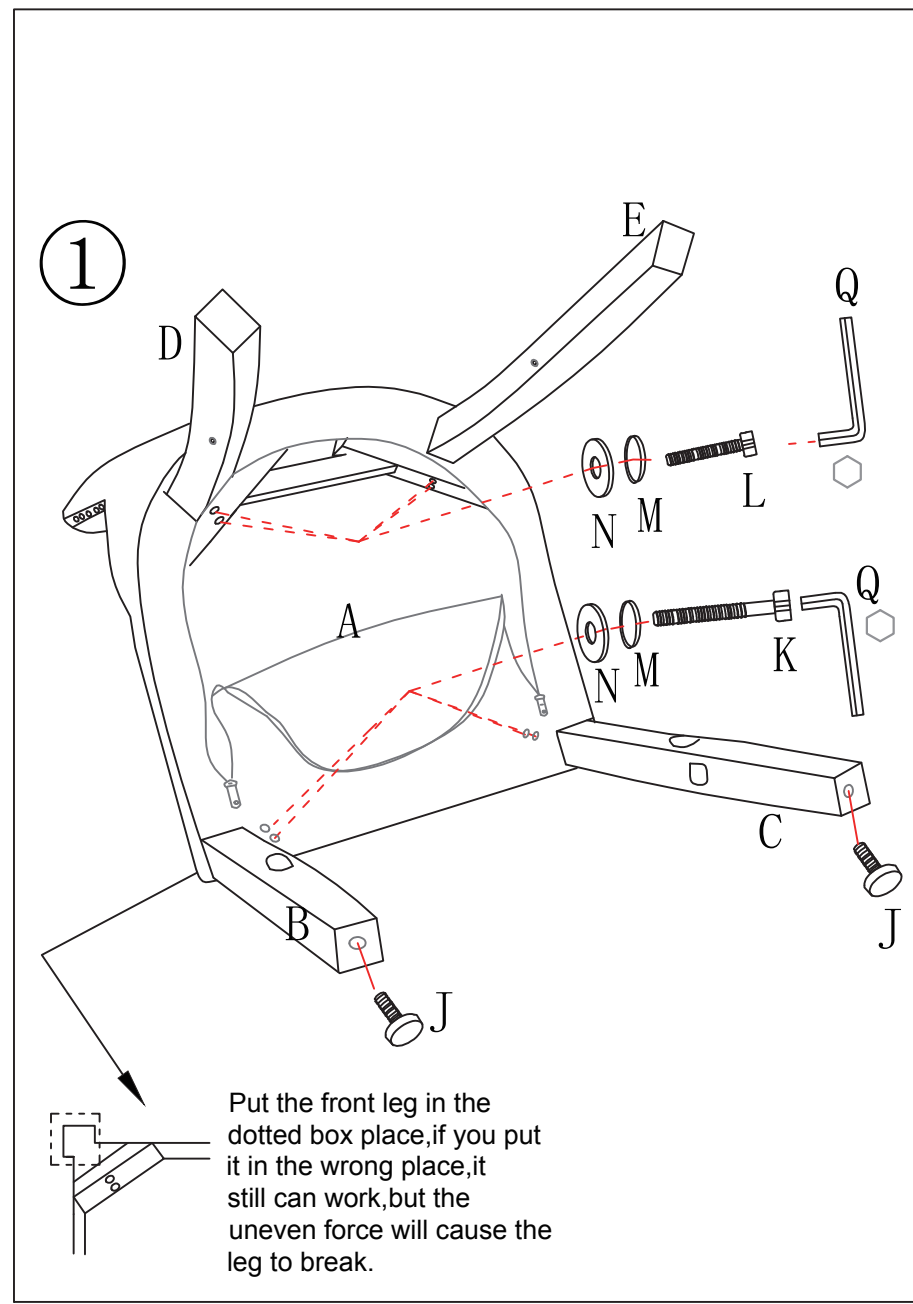
②

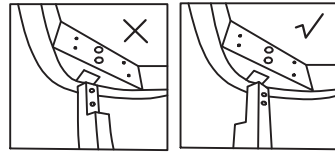

Tighten all the screws to 80% of maximum tightness

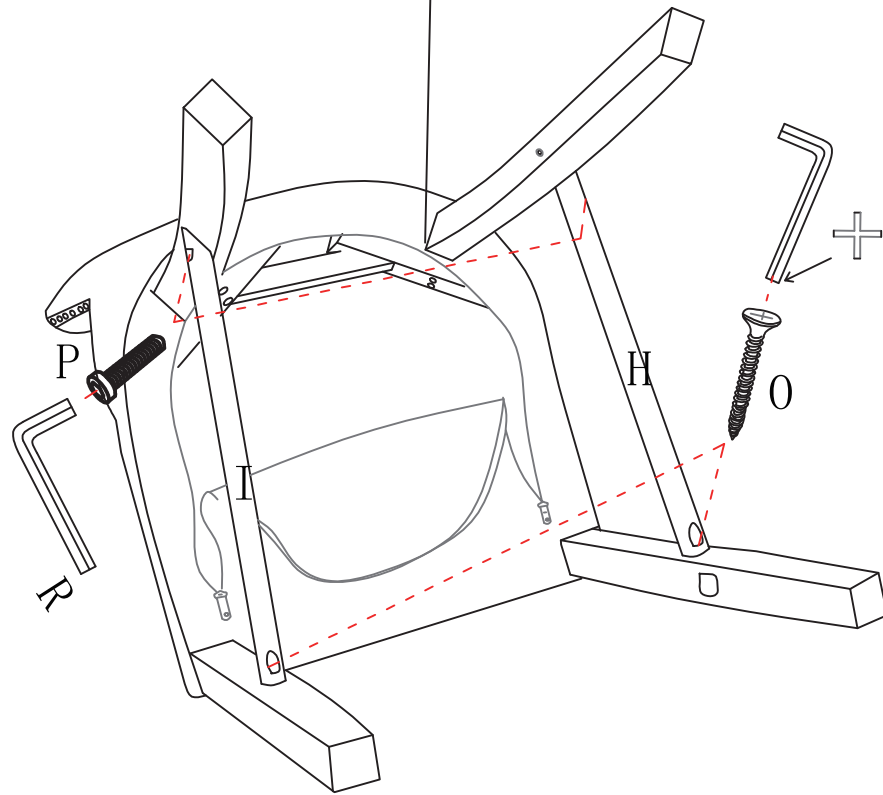

③

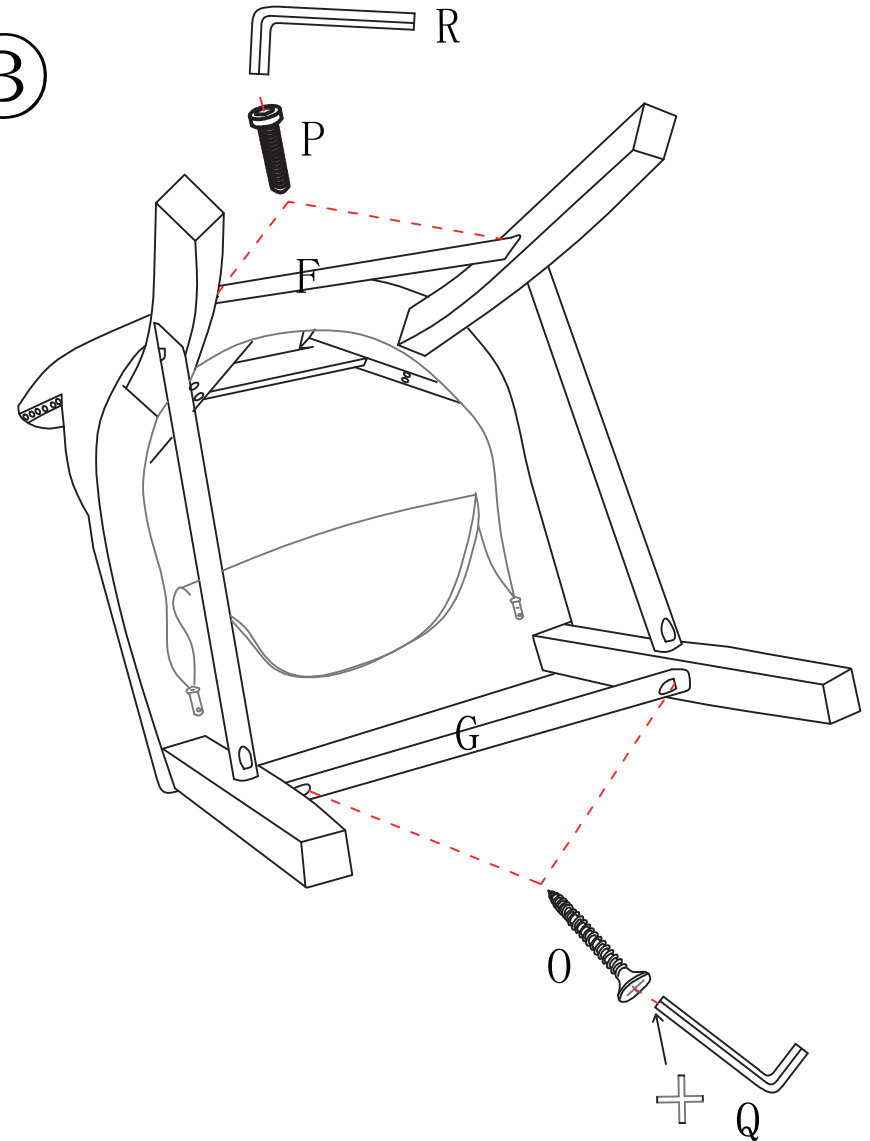

# ASSEMBLY INSTRUCTIONS

④

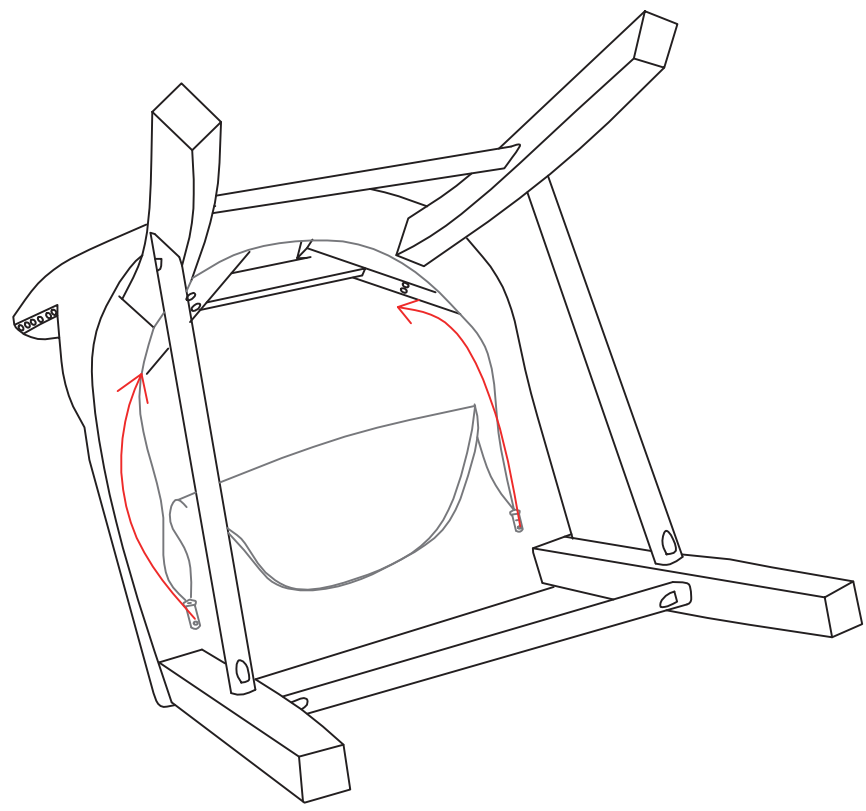

⑤

