

Instruction Manual

Round Folding Table 100cm



CONTENTS

Safety and care advice	1
Components	2
Assembly instructions	4
Copyright	10

⚠ SAFETY AND CARE ADVICE ⚠

PLEASE READ THESE INSTRUCTIONS CAREFULLY AND KEEP FOR FUTURE REFERENCE

- **Warning:** Please lift with care.
- Check you have all the components and tools listed on pages 2 and 3.
- Remove all fittings from the plastic bags and separate them into their groups.
- Keep children and animals away from the work area, small parts could choke if swallowed.
- Make sure you have enough space to lay out the parts before starting.
- Do not stand or put weight on the product, this could cause damage.
- Assemble the item as close to its final position (in the same room) as possible.
- Assemble on a soft level surface to avoid damaging the unit or your floor (use opened out unit carton).



- We do not recommend the use of power drill/drivers **for inserting screws**, as this could damage the unit. Only use hand screwdrivers.
- Dispose of all packaging carefully and responsibly.

CARE AND MAINTENANCE

- Only clean using a damp cloth and mild detergent, do not use bleach or abrasive cleaners.
- From time to time check that there are no loose screws on this unit.
- This product should not be discarded with household waste. Take to your local authority waste disposal center.

Note *If required the next page can be cut out and used as reference throughout the assembly. Keep this page with these instructions for future reference.*

COMPONENTS

Please check you have all the panels listed below:

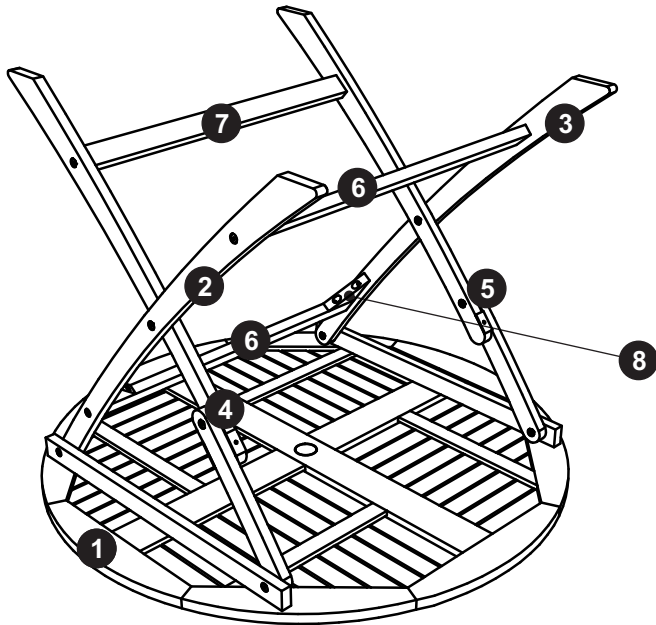

1. Tabletop	x 1	6. long bar	x 2
2. Leg 1	x 1	7. short bar	x 1
3. Leg 2	x 1	8. support legs	x 2
4. Leg 3	x 1		
5. Leg 4	x 1		



COMPONENTS

Please check you have all the fittings listed below:

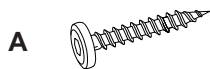

Screw ($\Phi 6 \times 35 \text{mm}$) x 4

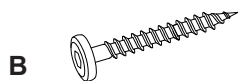

Screw ($\Phi 7 \times 60 \text{mm}$) x 6

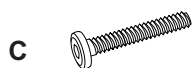

Bolt ($\Phi 8 \times 30 \text{mm}$) x 6

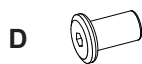

Caps ($\Phi 8 \times 15 \text{mm}$) x 6



Washers ($\Phi 8 / 18 \times 2 \text{mm}$) x 6

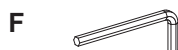

Allen key x 2





Parasole Cap





ASSEMBLY INSTRUCTIONS

Step 1

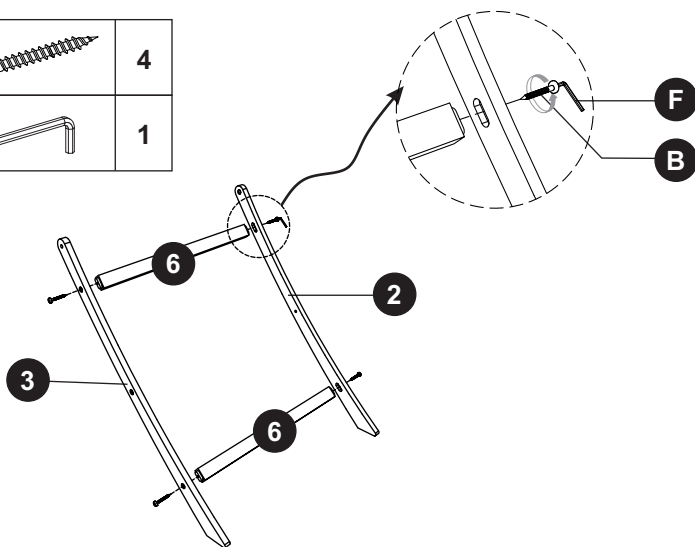
B		4
F		1



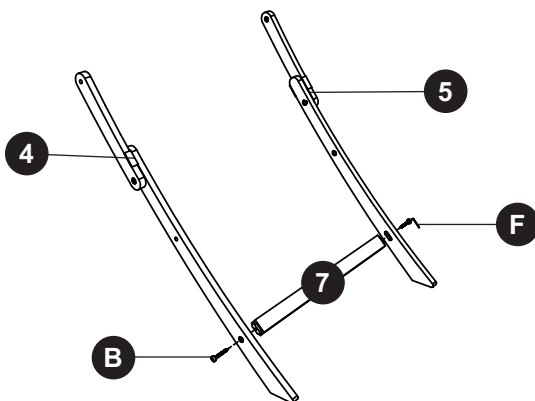

Step 2

B		2
F		1



ASSEMBLY INSTRUCTIONS

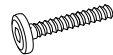

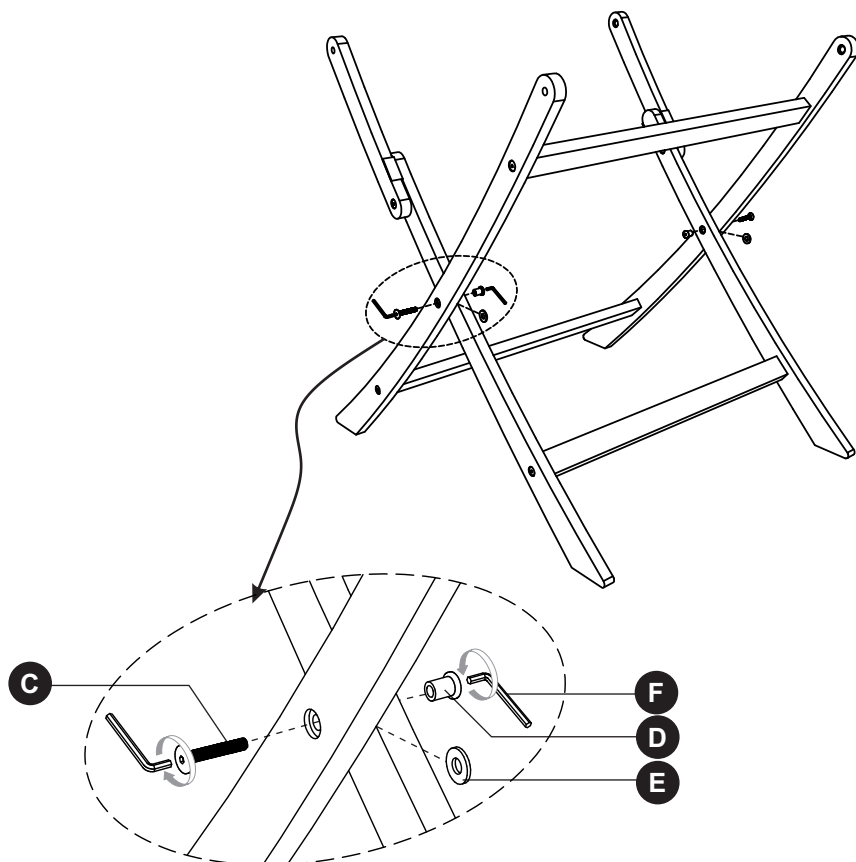

Step 3

C		2
D		2
E		2
F		2

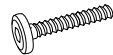

ASSEMBLY INSTRUCTIONS

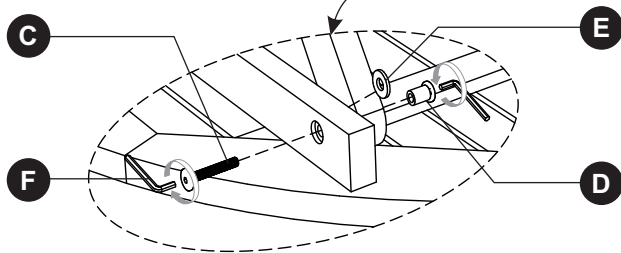
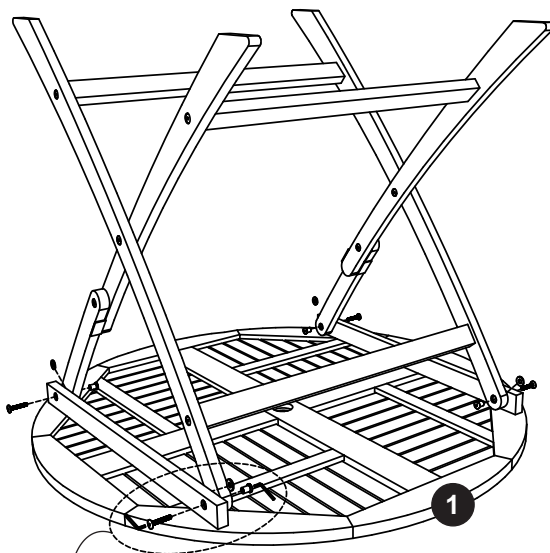

Step 4

C		4
D		4
E		4
F		2

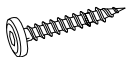

ASSEMBLY INSTRUCTIONS

Step 5

A		4
F		1
G		1

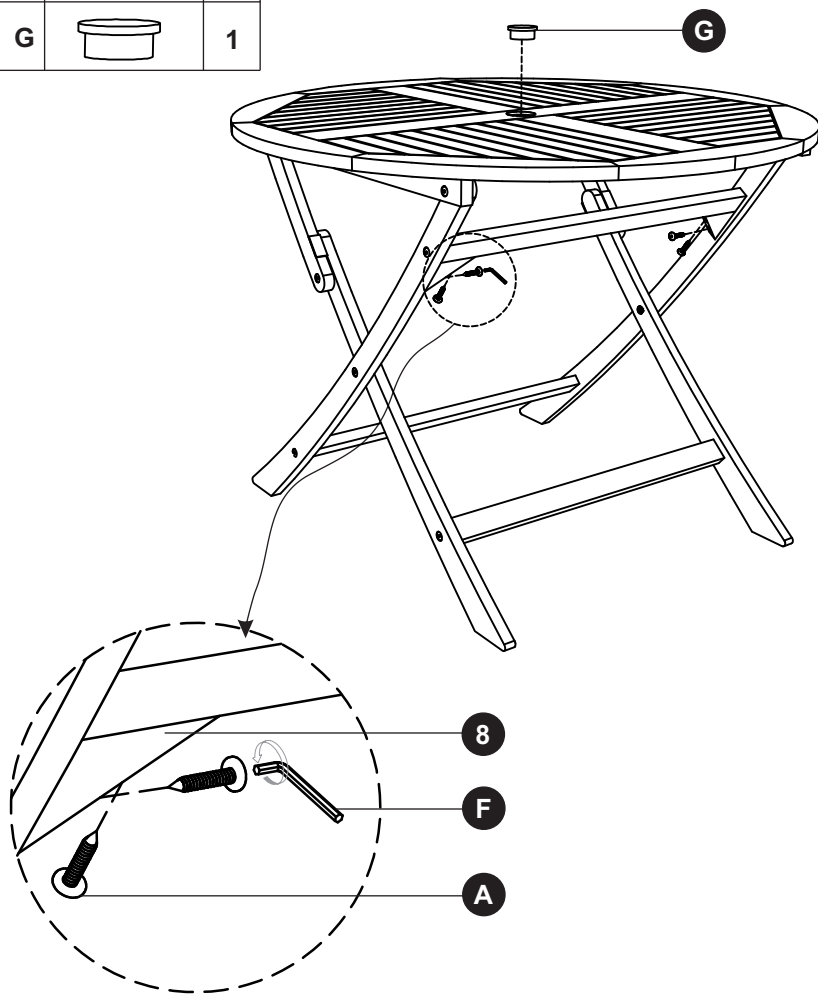

ASSEMBLY INSTRUCTIONS

Step 6

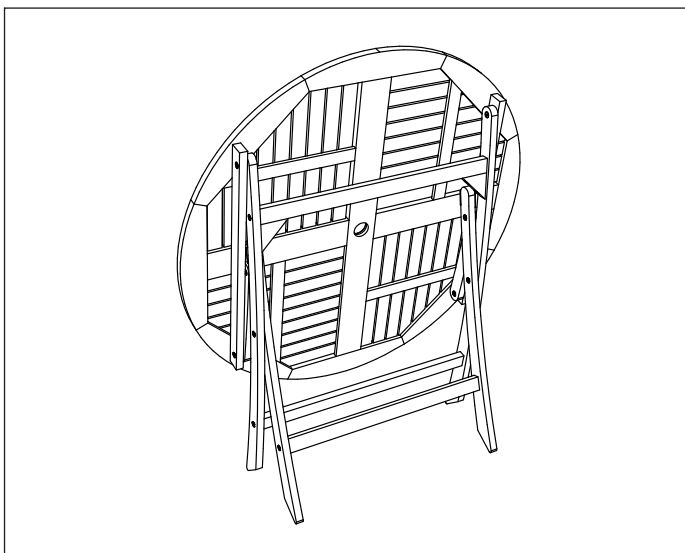

Congratulations! Now you have finished assembling the product.

IF YOU FIND A DEFECTIVE PART

We fully stock all parts and components. Any defective part can be quickly replaced. Take note of the defective part number in manual and we will arrange a quick replacement.

COPYRIGHT

All material in this instruction manual is copyrighted

Any unauthorised use may violate worldwide copyright, trademark and other laws.