

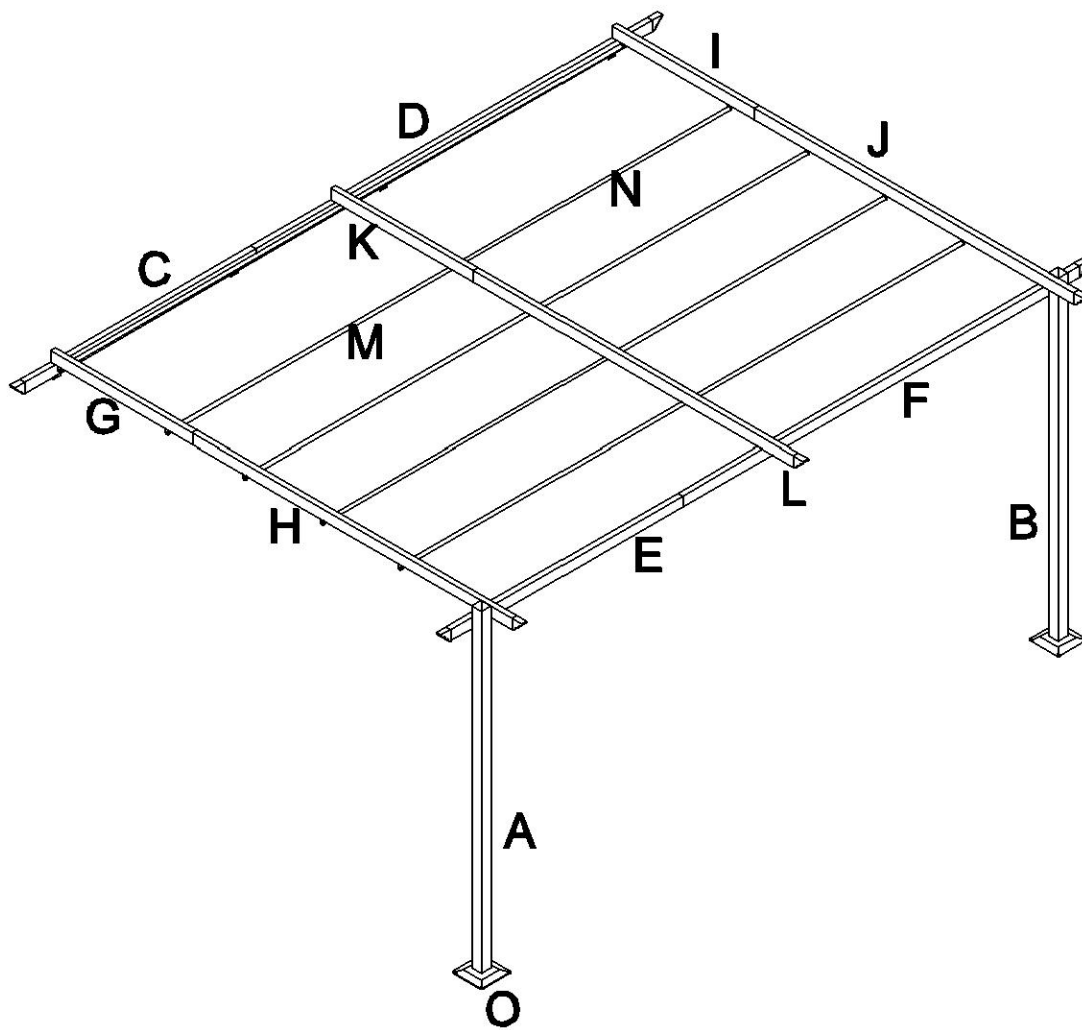

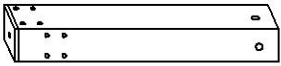

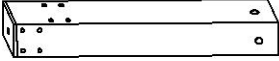





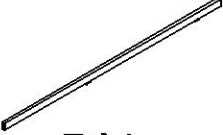

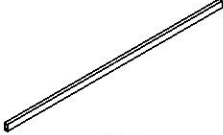

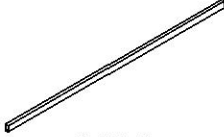

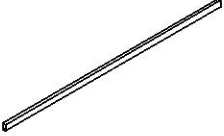
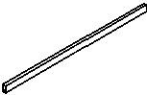

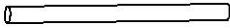
Installation & Assembly

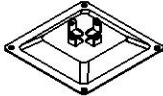
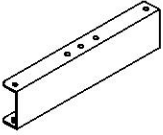
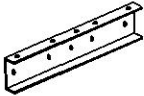

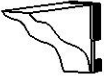
 <p>A*1</p>	 <p>B*1</p>	 <p>C*1</p>
 <p>D*1</p>	 <p>E*1</p>	 <p>F*1</p>
 <p>G*1</p>	 <p>H*1</p>	 <p>I*1</p>
 <p>J*1</p>	 <p>K*1</p>	 <p>L*1</p>
 <p>M*6</p>	 <p>N*6</p>	 <p>O*2</p>
 <p>P*2</p>	 <p>Q*3</p>	 <p>R*1</p>
 <p>S*1</p>	 <p>T*7</p>	 <p>U*5</p>
 <p>V*12</p>	 <p>W*2</p>	 <p>X*1</p>



Y*1



Z*1



X38

M6*15



X24

M6*10



X3

M6*40



X4

M6*75

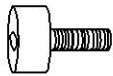

X16

M6*15



X12

M6*50

1

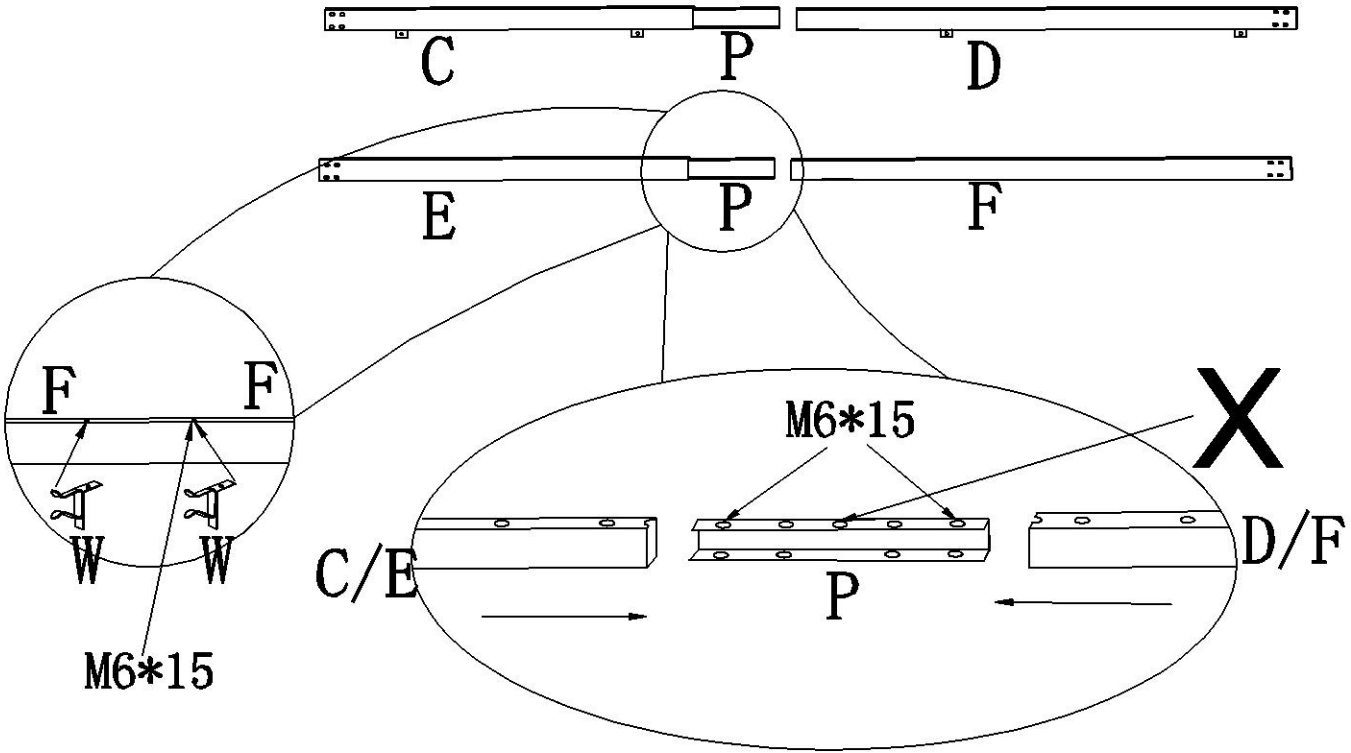
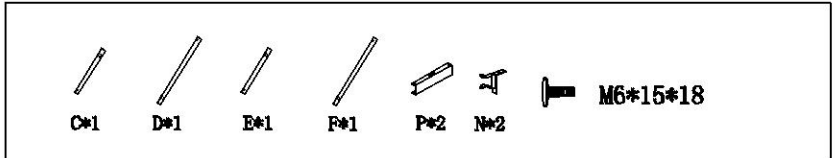

2

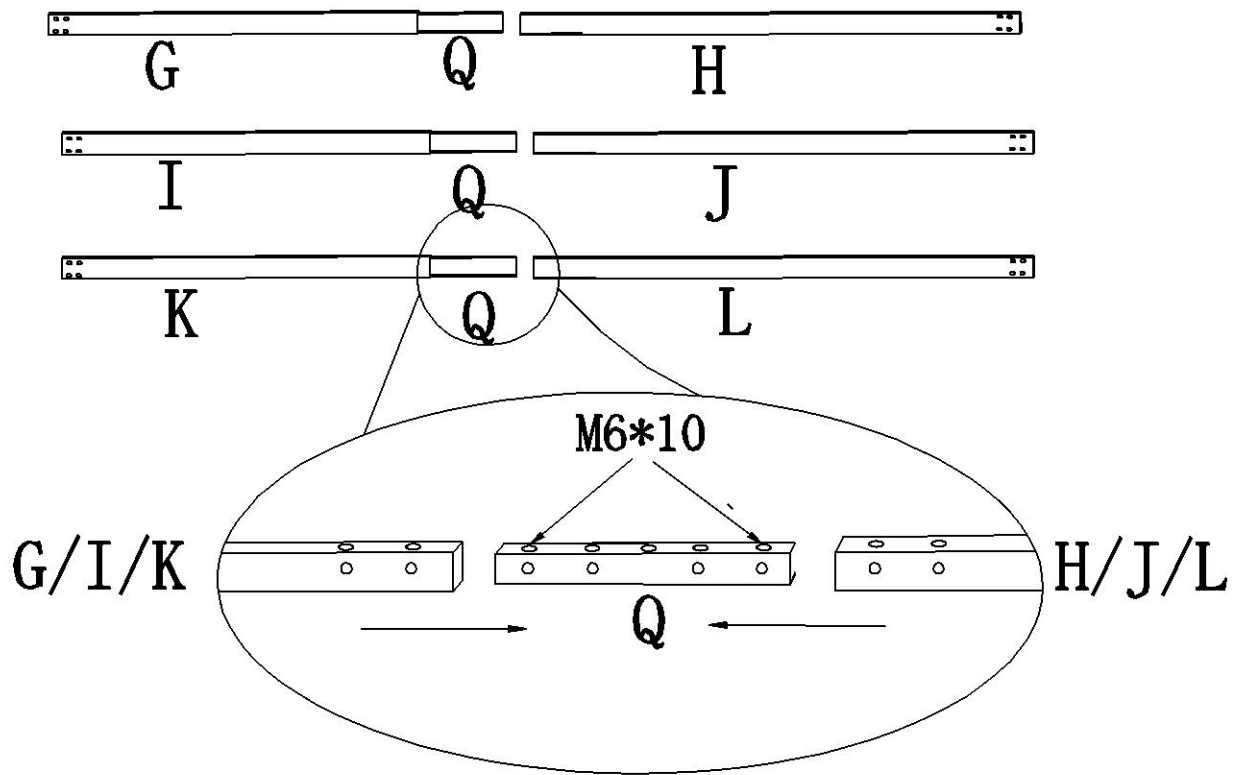
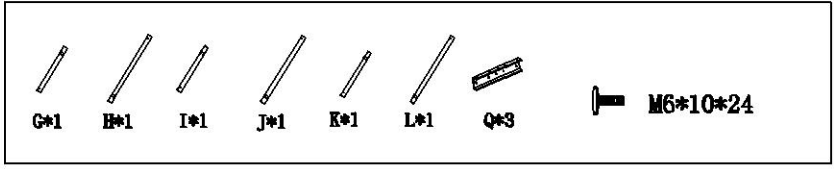

3

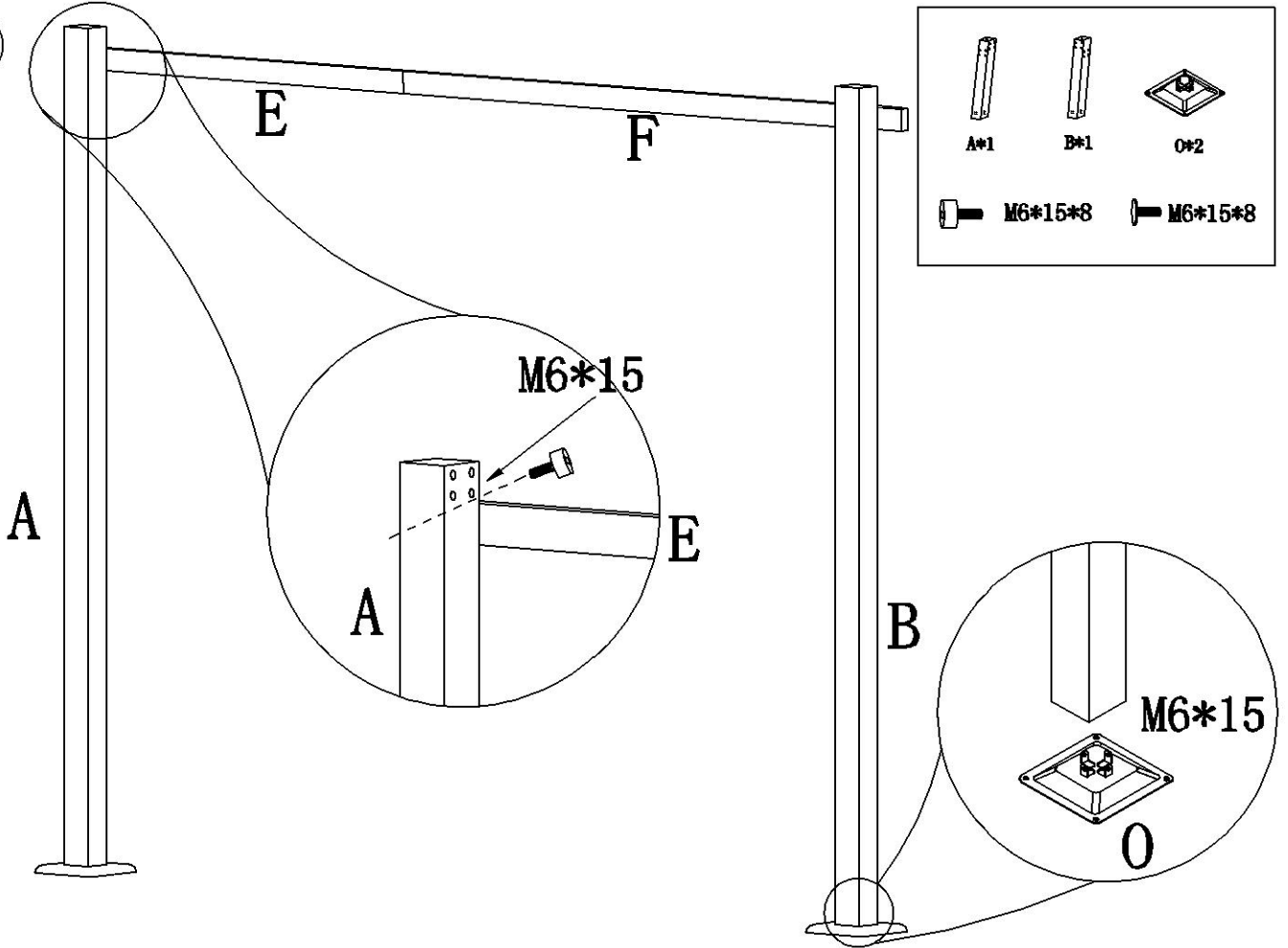

4

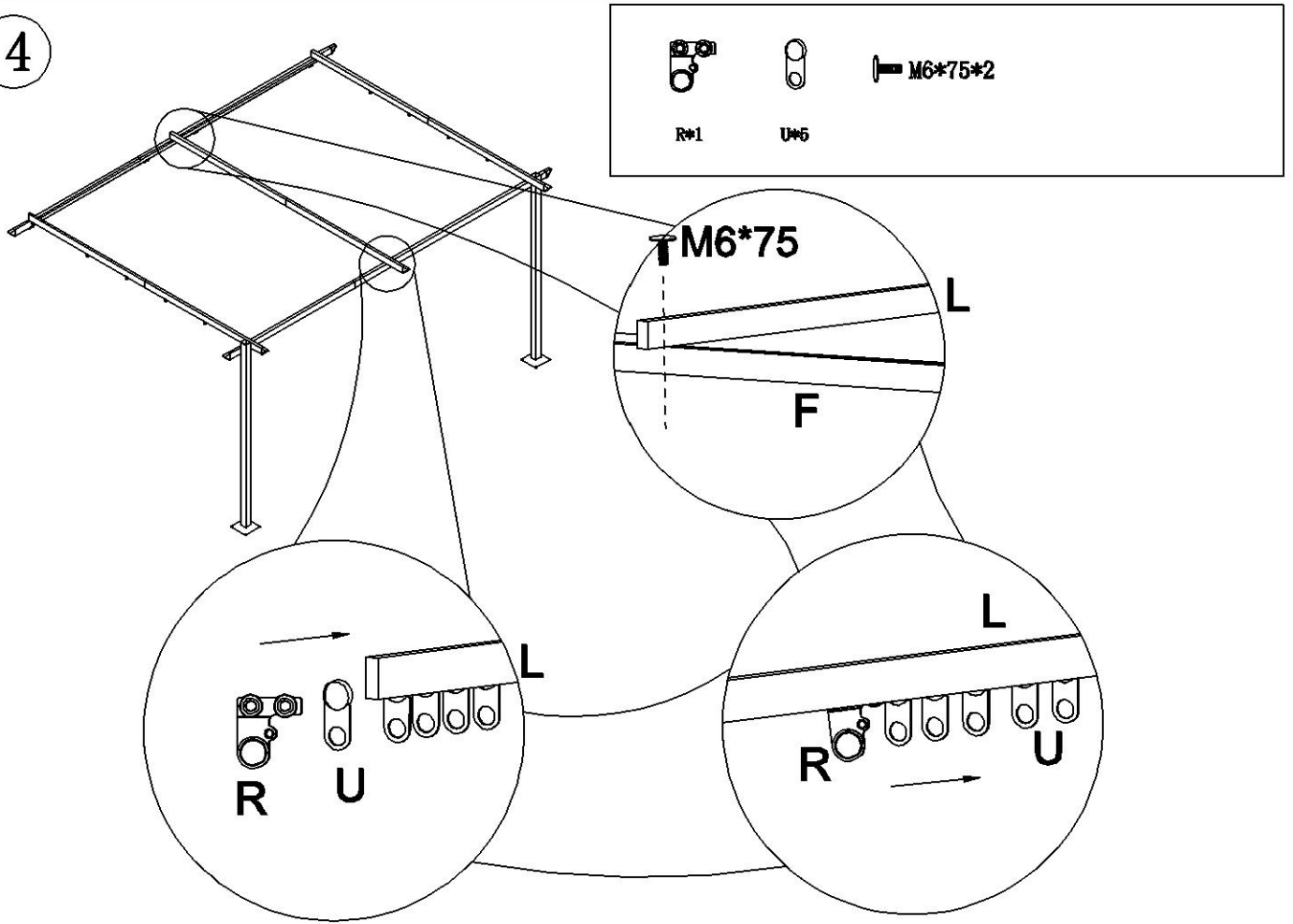

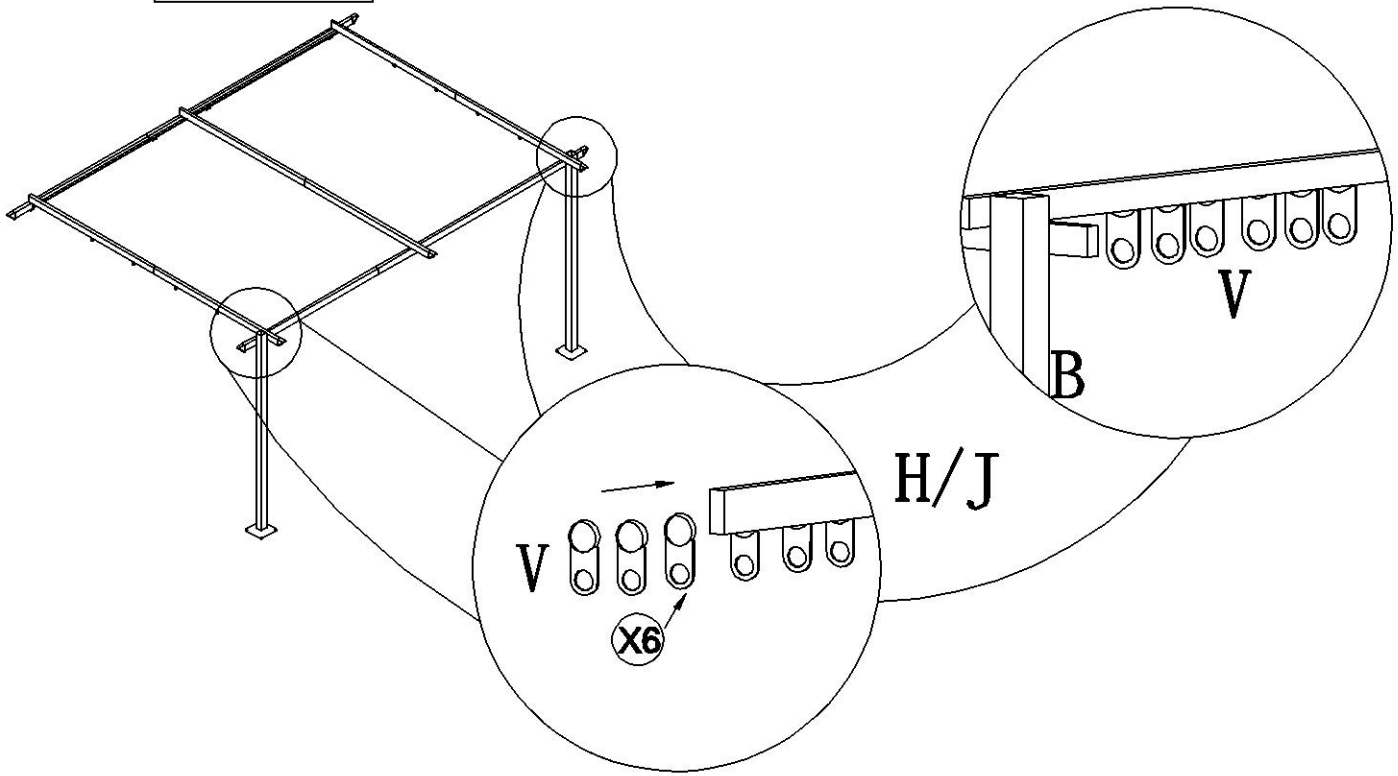

5

V*12



6

 M6*15*8  M6*75*2

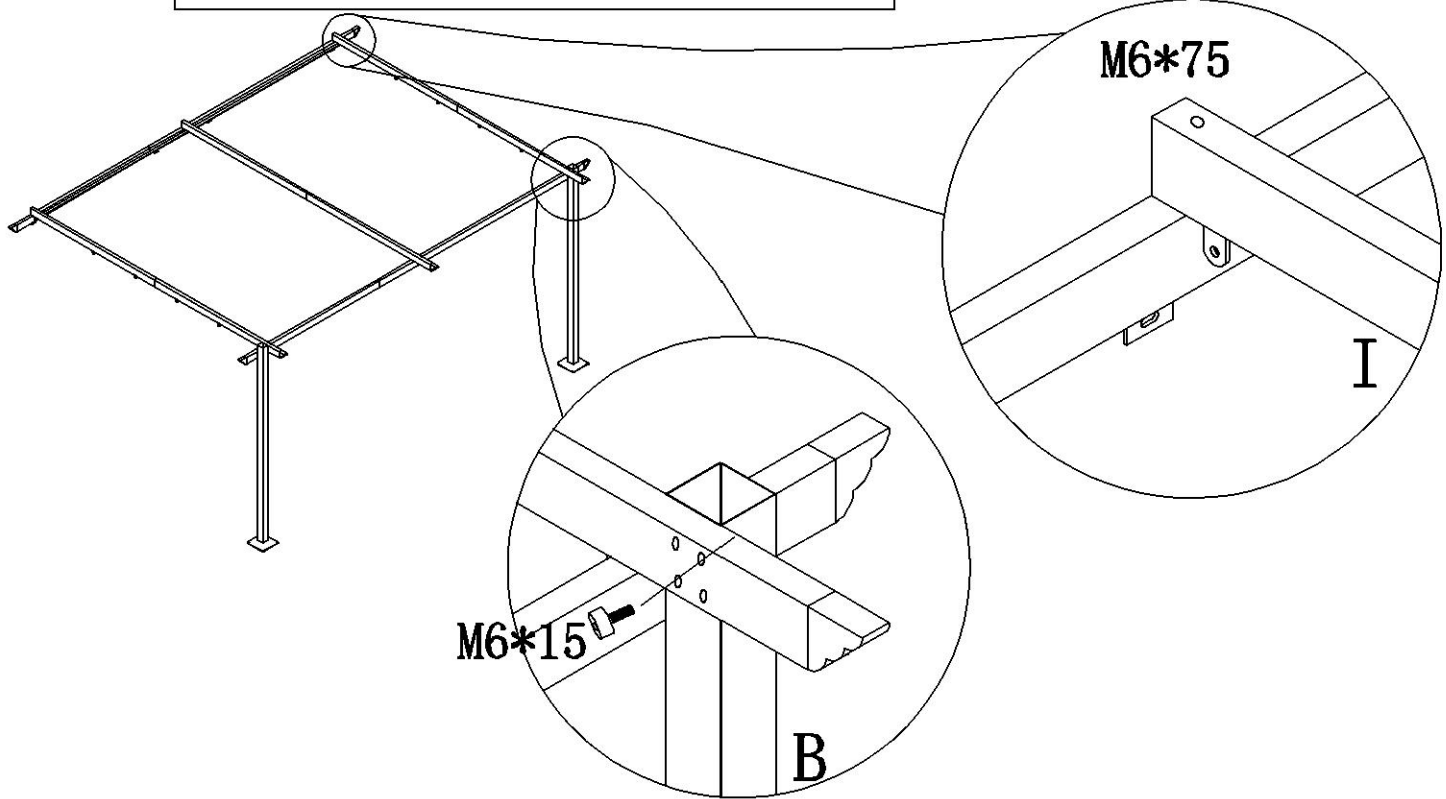

7

1

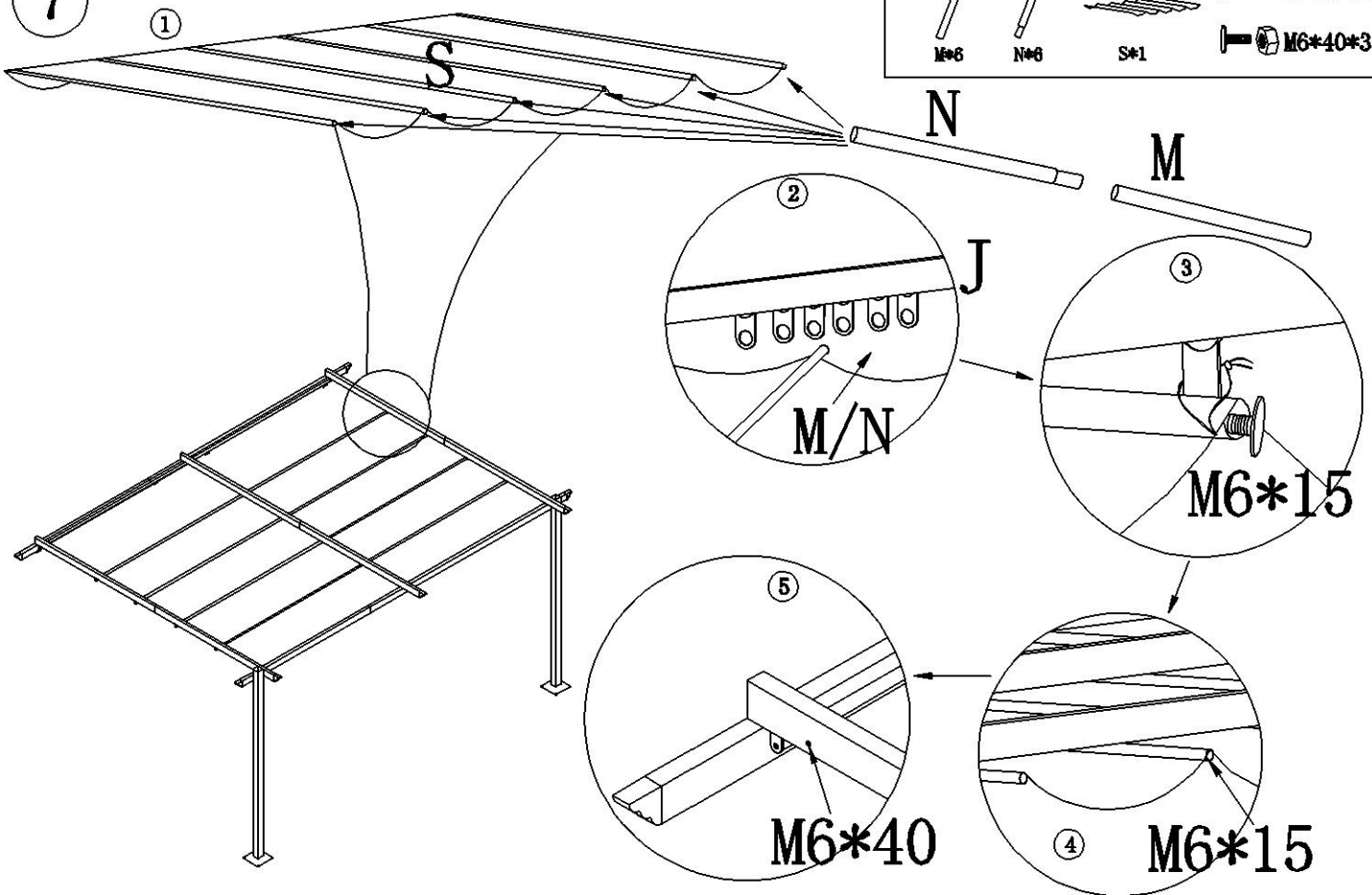

8

