

# ASSEMBLY INSTRUCTIONS

## ASSEMBLY TIPS:

- 1 . Remove hardware from box and sort by size.
- 2 . Please check to see that all hardware and parts are present prior to start of assembly.
- 3 . Please follow attached instructions in the same sequence as numbered to assure fast & easy assembly.



### Warning !

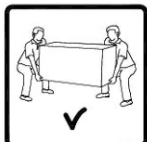

- 1 . Don't attempt to repair or modify parts that are broken or defective. Please contact the store immediately.
- 2 . This product is for home use only and not intended for commercial establishment.





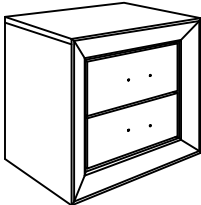
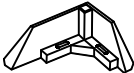
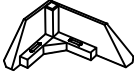

ASSEMBLY TIME

15 MINUTES

## PARTS IDENTIFICATION

A.		NIGHT STAND		1 PC
B.		RIGHT FRONT LEG	<b>FR</b>	1 PC
C.		LEFT FRONT LEG	<b>FL</b>	1 PC
D.		RIGHT BACK LEG	<b>BR</b>	1 PC
E.		LEFT BACK LEG	<b>BL</b>	1 PC

## HARDWARE IDENTIFICATION

1.		BOLT		8 PCS
2.		LOCK WASHER		8 PCS
3.		FLAT WASHER		8 PCS
4.		ALLEN WRENCH		1 PC

NOTE : PHILLIPS HEAD SCREW DRIVER IS REQUIRED IN THE ASSEMBLY PROCESS. HOWEVER, MANUFACTURER DOES NOT PROVIDE THIS ITEM.

ASSEMBLY INSTRUCTIONS

STEP 1

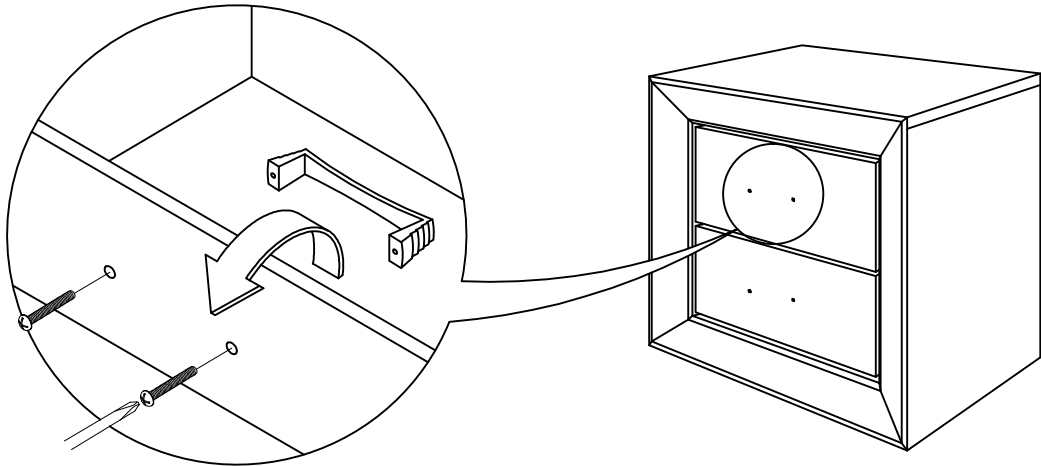

STEP 2

