

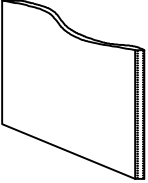

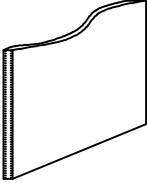

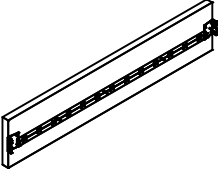

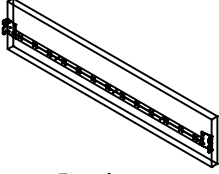

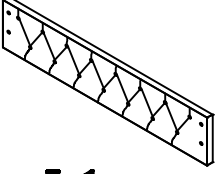
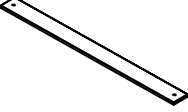



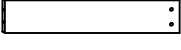
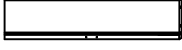
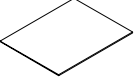









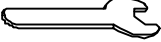



# ASSEMBLY INSTRUCTION

			
<b>A: 1pc</b>	<b>B: 1pc</b>	<b>C: 1pc</b>	<b>D: 1pc</b>
			
<b>E: 1pc</b>	<b>F: 4pcs</b>	<b>G: 9pcs</b>	<b>H: 2pcs</b>
			
<b>I: 2pcs</b>	<b>J: 2pcs</b>	<b>K: 2pcs</b>	<b>L: 2pcs</b>
			
<b>M: 2pcs</b>	<b>N: 1pcs</b>	<b>O: 2pcs</b>	
			
<b>M8*30mm</b> <b>1: 12pcs</b>	<b>M8*60mm</b> <b>2: 4pcs</b>	<b>M6*80mm</b> <b>3: 4pcs</b>	<b>M6*40mm</b> <b>4: 4pcs</b>
			
<b>M6*10mm</b> <b>5: 8pcs</b>	<b>6: 28pcs</b>	<b>7: 28pcs</b>	<b>8: 1pc</b>
			
<b>M8</b> <b>9: 1pc</b>	<b>M6</b> <b>10: 1pc</b>	<b>11: 4pcs</b>	<b>12: 18pcs</b>
			
<b>13: 8pcs</b>	<b>8*30mm</b> <b>14: 12pcs</b>	<b>8*16mm</b> <b>15: 32pcs</b>	<b>16: 12pcs</b>
			
<b>17: 12pcs</b>	<b>M8*50mm</b> <b>18: 4pcs</b>	<b>M8*13mm</b> <b>19: 4pcs</b>	<b>M8*13mm</b> <b>20: 1pc</b>

### STEP 1:

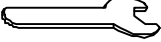
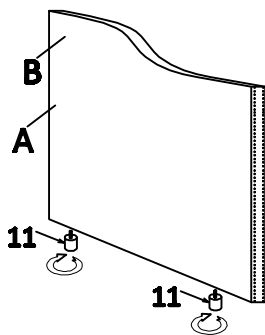

### STEP 2:

- 1 12PCS
- 6 16PCS
- 7 16PCS
- 9 1PC
- 18 4PCS
- 20 1PCS
- 19 4PCS

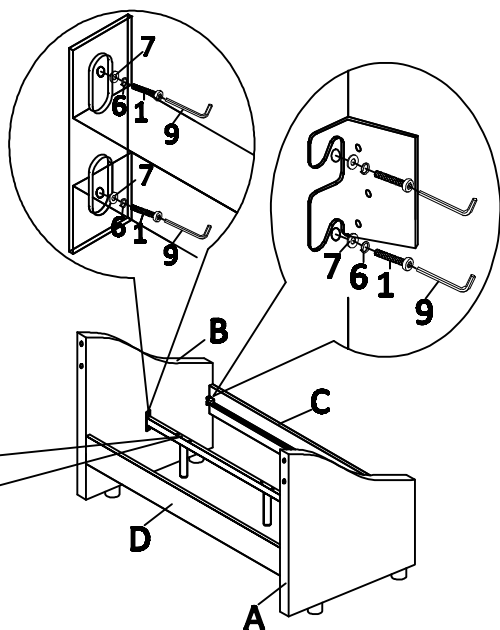

### STEP 3:

- 3 4PCS
- 4 4PCS
- 6 8PCS
- 7 8PCS
- 10 1PC
- 8 1PC
- 5 8PCS

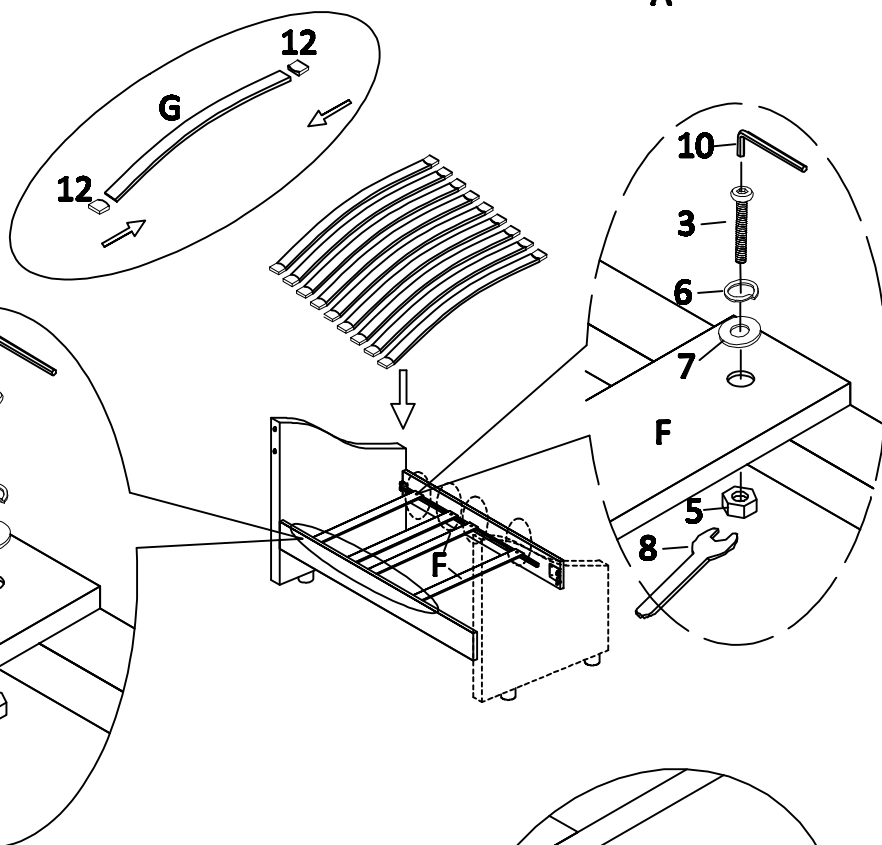

### STEP 4:

- 2 4PCS
- 6 4PCS
- 7 4PCS
- 9 1PC

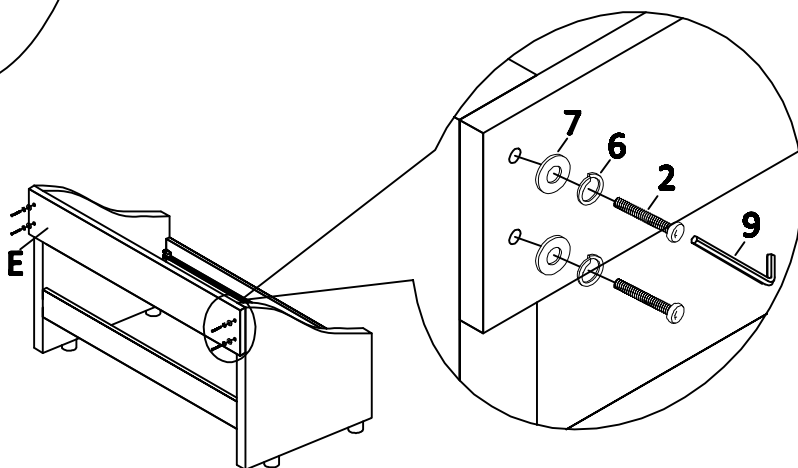

**STEP 5:**

15  32PCS

9  1PC

13  8PCS

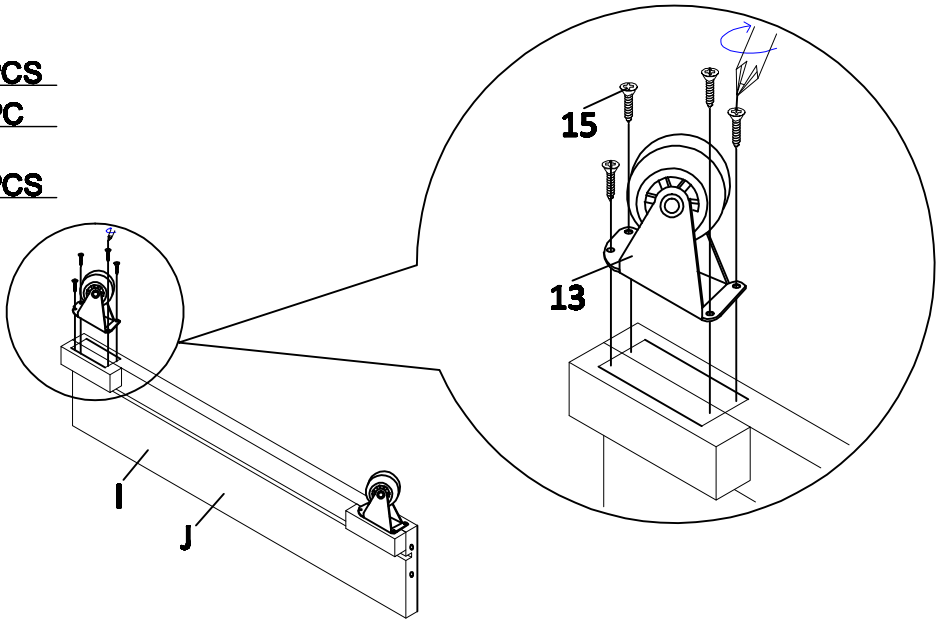

**STEP 6:**

16  12PCS

17  12PCS

**ASSEMBLY TOOLS REQUIRED (NOT INCLUDED)**

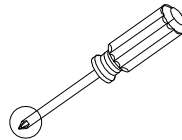
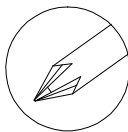

Screwdriver

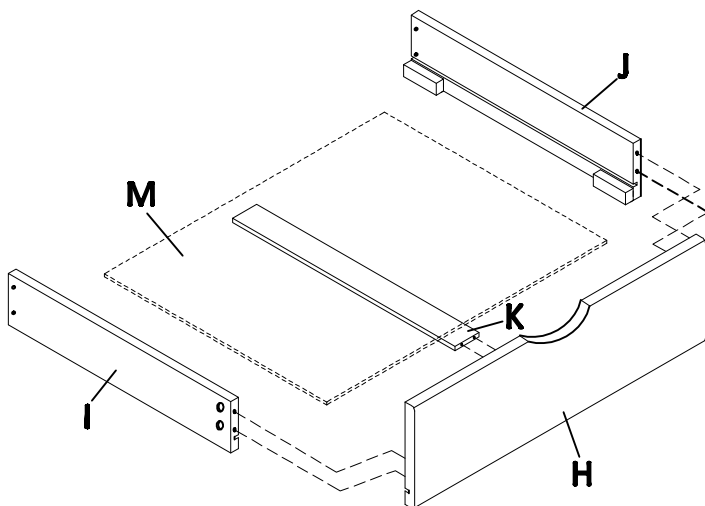
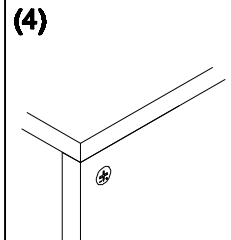
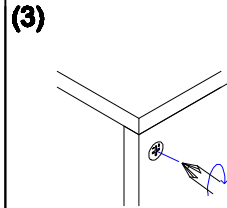
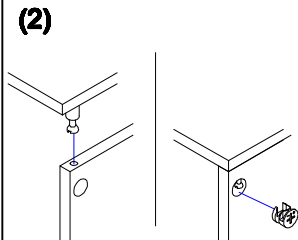
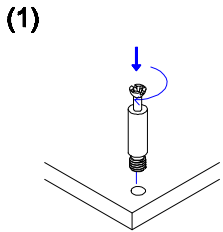

**STEP 7:**

14  12PCS

9  1PC

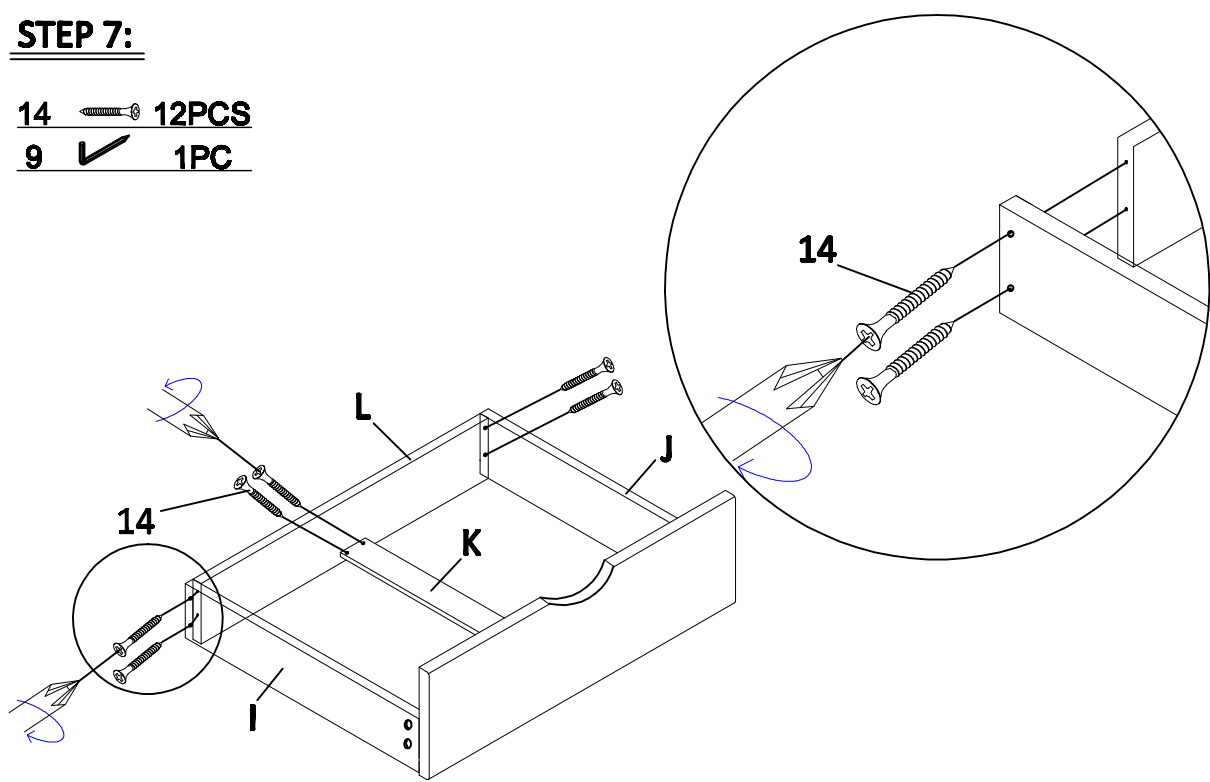

**STEP 8:**

