

NOTICE

- * Please make sure that you have all parts indicated and they are in good condition before you begin assembly of this item. Refer to part list and hardware list below for guidance.
- * This item should be assembled on a soft surface to prevent scratching the finish during assembly.
- * This item may require periodic tightening.
- * If you are having difficulty, our friendly Customer Care team is always here to help. Please Email customersupport@safavieh.com

PREPARATION

- * Before beginning assembly of product, make sure all parts are present. Compare parts with part contents list and hardware contents list.
- * If any part is missing or damaged, do not attempt to assemble the product.
- * Estimated Assembly Time: 10 minutes.
- * Tools Required for Assembly (included): Allen Key.

CARE AND MAINTENANCE

WOOD CARE: Adhesive felt pads should always be applied to areas of furniture which make direct contact with flooring, said application will prevent damage to the furniture and or surfaces on which the furniture lies. Objects placed on articles of furniture should rest on nonabrasive material as to prevent damage to the wood finish. Wipe up spills immediately and avoid common hazards such as hot dishes, harsh solvents and abrasives. Cleaning should be done with a soft lint free cotton cloth dampened with water or furniture polish.



ITEM ID: DTB3600A

ITEM DIMENSTION: 47.24" X 29.53" X 29.53"



⚠WARNING⚠





Weight Capacity - 225 LBS

Warning : Do not stand on Table

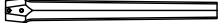
Warning : Do not over torque bolts

Part List And Hardware List

PIECE	DISCRIPTION	PICTURE	QTY	PIECE	DISCRIPTION	PICTURE	QTY
A	TOP FRAME		X1	B	LEG		X4

HW1	ALLEN KEY M4		X1	HW3	SPRING WASHER		X8
HW2	M6 X 50MM JCBC SCREW		X8	HW4	FLAT WASHER		X8

PREPARATION

- * Before beginning assembly of product, make sure all parts are present. Compare parts with part contents list and hardware contents list.
- * If any part is missing or damaged, do not attempt to assemble the product.
- * Estimated Assembly Time: 10 minutes.
- * Tools Required for Assembly (included): Allen Key.



STEP 1: PUT THE WASHERS (HW3, HW4) ON THE BOLT. IN THE ORDER SHOWN IN THE PICTURE.

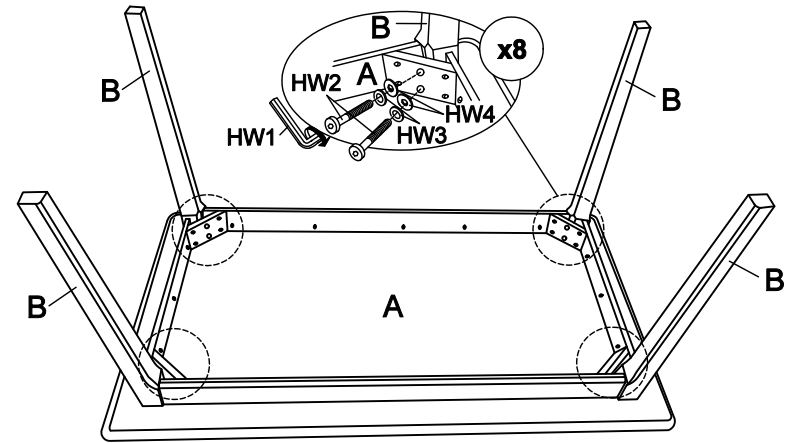

STEP 2: ATTACH THE LEGS (B) TO TOP FRAME (A) AND SCREW IN THE BOLTS.