

READ ALL INSTRUCTIONS BEFORE USE

Warning & Attention

-This gazebo is not a toy. Children are not allowed to assemble or disassemble. Please take care of children, do not let them play around when assemble or disassemble.

-Adults only for assemble or disassemble this product.









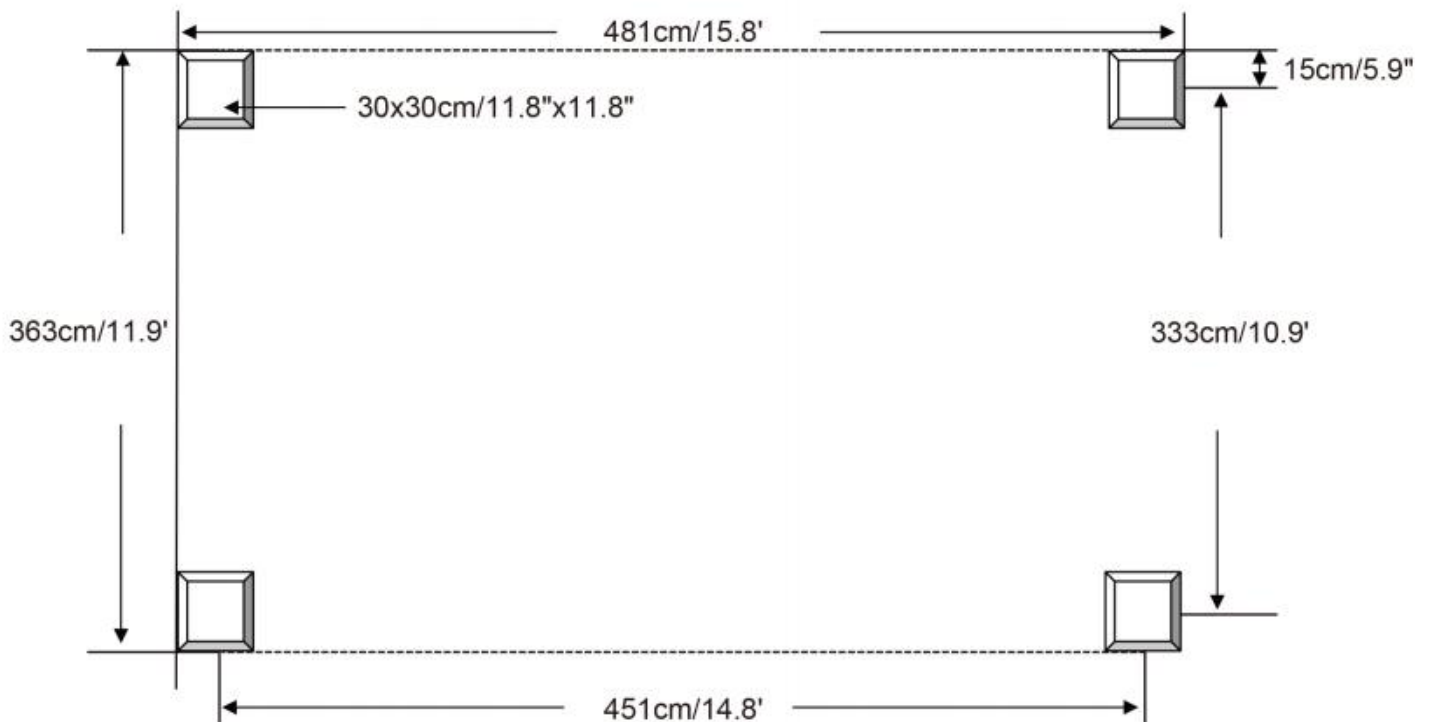

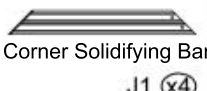
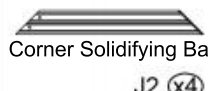
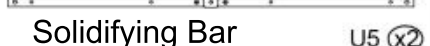

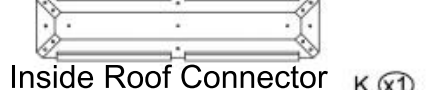
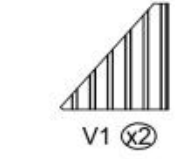
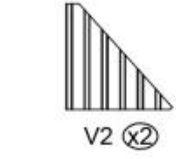



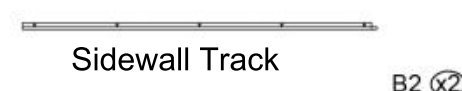

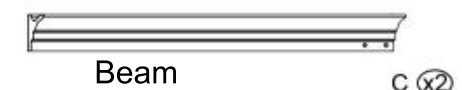

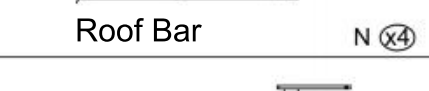



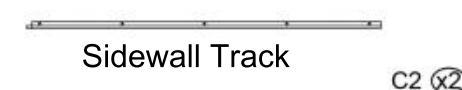
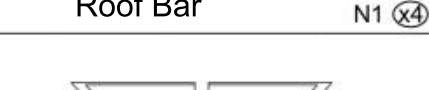
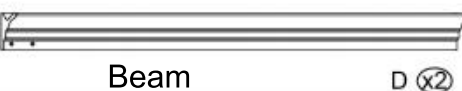
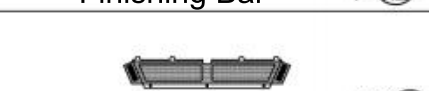

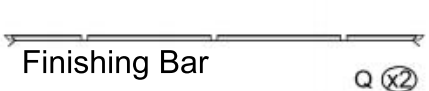

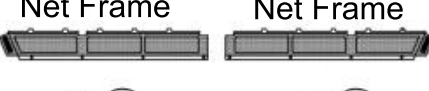

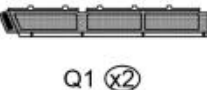
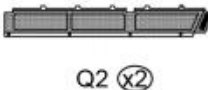



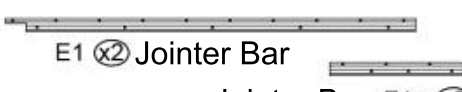
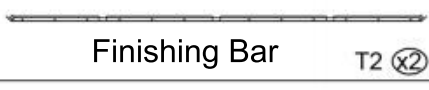





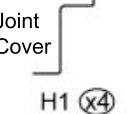
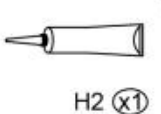

-This product is constructed with heavy duty frame, please do not lean or climb before it finish assembling.

-Even though our hardtop gazebo is sturdy, please do not stand under the gazebo during a lightning storm.







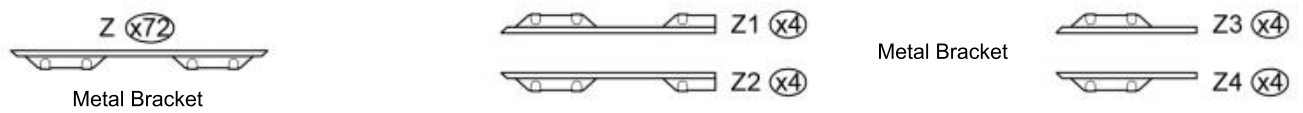
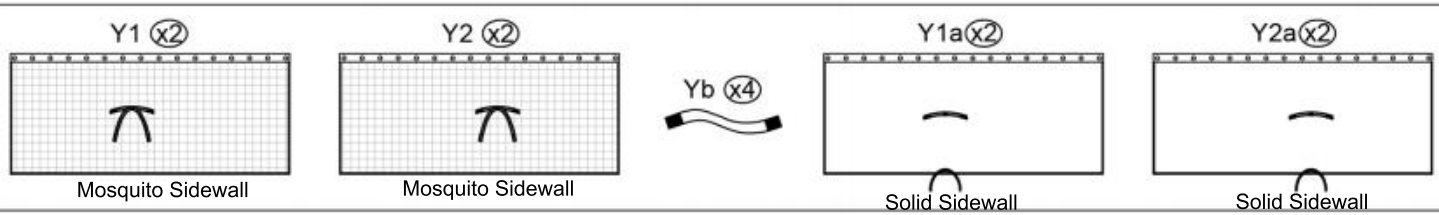
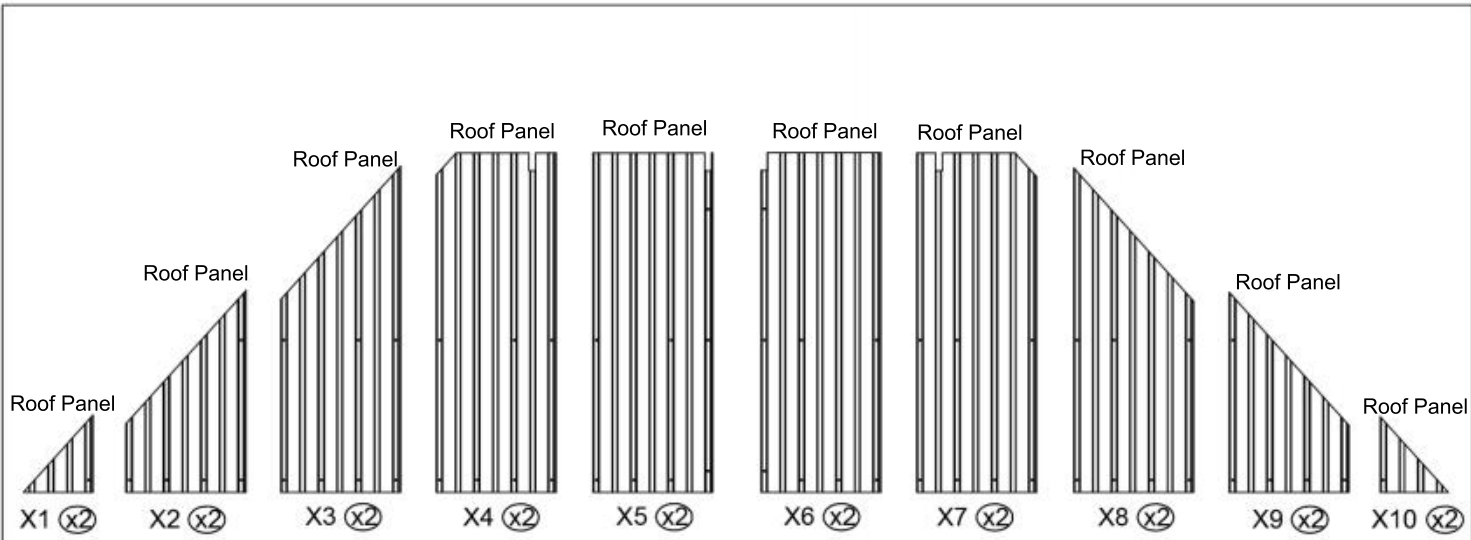

-DO NOT use this gazebo if any parts show signs of instability or damage.

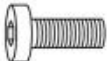
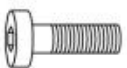
12'x16' ANCHOR BLUEPRINT

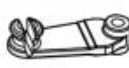
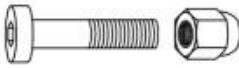
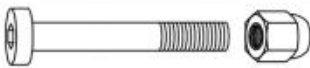

 Pole A (x4)	 Corner Solidifying Bar J1 (x4)	 Corner Solidifying Bar J2 (x4)	 Solidifying Bar U5 (x2)			
 Beam B (x2)	 Inside Roof Connector K (x1)		 Roof Panel V1 (x2)	 Roof Panel V2 (x2)		
 Joint Bar B1 (x2)	 Outside Roof Connector K1 (x1)		 Roof Panel V (x4)			
 Sidewall Track B2 (x2)	 Base L (x4)					
 Beam C (x2)	 Corner Roof Bar M (x4)					
 Jointer Bar C1 (x2)	 Roof Bar N (x4)		 Roof Panel V3 (x2)	 Roof Panel V4 (x2)	 Roof Panel V5 (x2)	 Roof Panel V6 (x2)
 Sidewall Track C2 (x2)	 Roof Bar N1 (x4)					
 Beam D (x2)	 Finishing Bar P (x2)					
 Jointer Bar D1 (x2)	 Net Frame P1 (x2)					
 D1a (x2)	 Finishing Bar Q (x2)					
 Jointer Bar D1a (x2)	 Net Frame Q1 (x2)					
 Net Frame Q2 (x2)	 Finishing End R (x8)					
 Spacer S (x136)	 Finishing Bar T1 (x2)					
 Sidewall Track D2 (x2)	 Finishing Bar T2 (x2)					
 Beam E (x2)	 Solidifying Bar U1 (x4)					
 E1 (x2)	 Solidifying Bar U2 (x4)					
 Jointer Bar E1a (x2)	 Iron Angle U3 (x4)					
 Iron Angle U4 (x6)	 Corner Cover G (x4)					
 Joint Cover H (x4)	 Joint Cover H1 (x4)	 Joint Cover H2 (x1)	 Roof Panel W1 (x2)	 Roof Panel W2 (x2)	 Roof Panel W7 (x2)	 Roof Panel W8 (x2)
			 Roof Panel W3 (x2)	 Roof Panel W4 (x2)	 Roof Panel W5 (x2)	 Roof Panel W6 (x2)

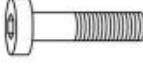

	M6x16	Screws	1# x259+4
	M6x20	Screws	2# x16+2
		Screws	3# x16+2
		Hook	4# x128
	M6x28	Screws	5# x84+2
	M6x45	Screws	6# x8+1
	M6x50	Screws	7# x40+2
	M5x16	Screws	8# x4+1
	ST4.8x13	Screws	9# x24+2
	M6x25	Screws	10# x4+1
	M6x10	Screws	11# x12+1



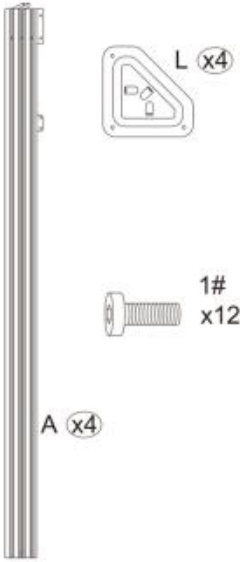

Step 1:
Set up Part A with Part L using
screws 1#.

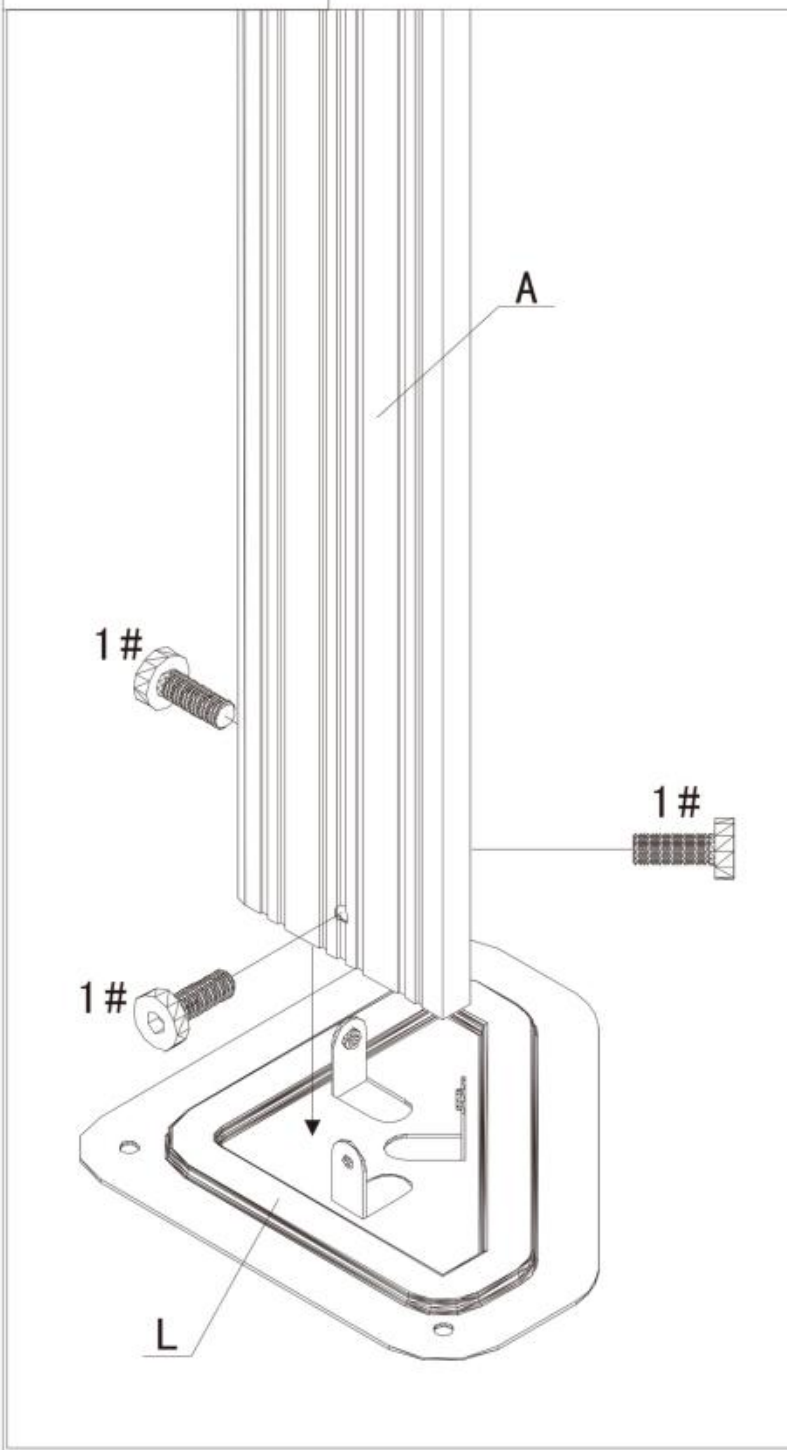
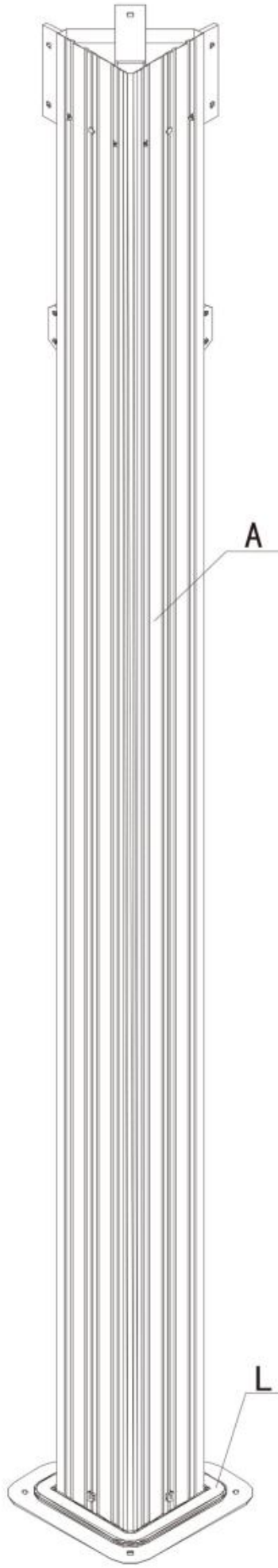

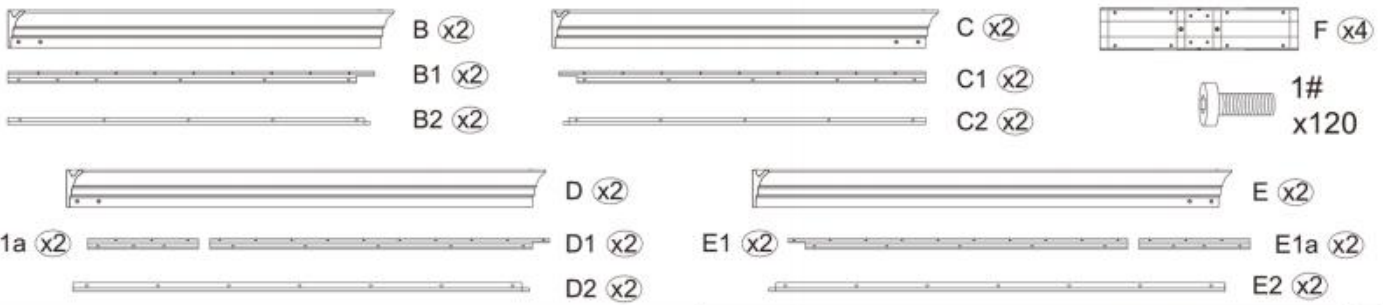

Step 2:

Connect Part C and Part B with Part F using screws 1#.

Connect Part E and Part D with Part F using screws 1#.

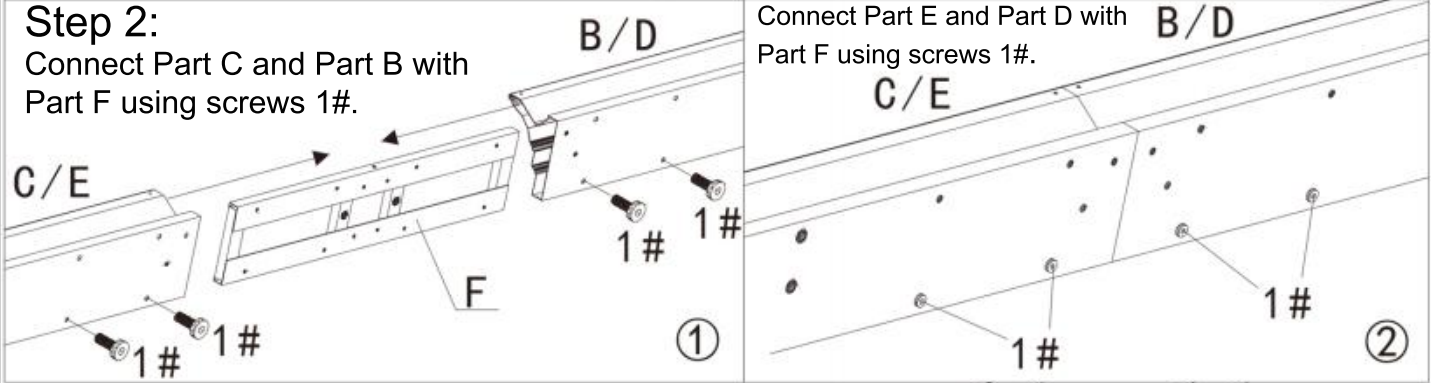

③

Step 3:

Attach Part (C2&B2) to Part (C&B) using screws 1#.

Attach Part (E2&D2) to Part (E&D) using screws 1#.

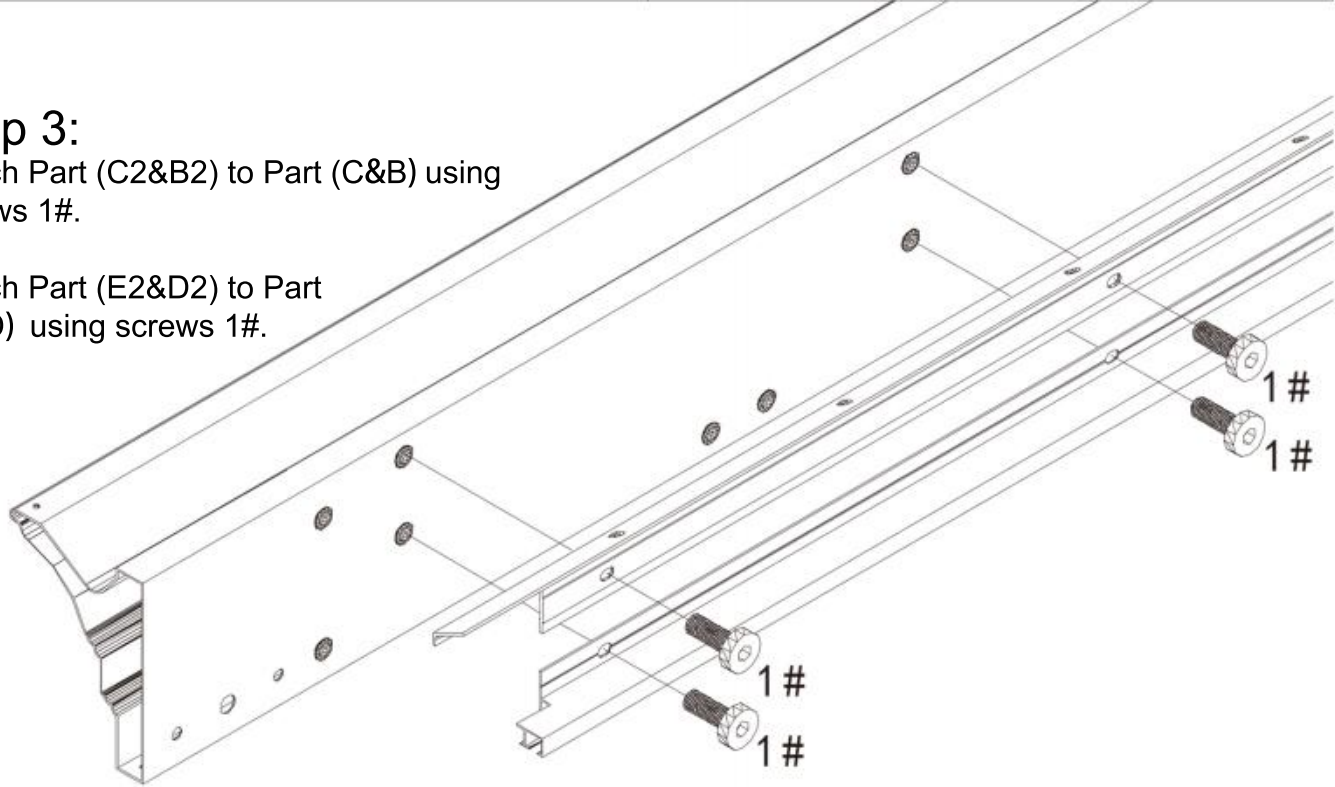

Attach Part (C1&B1) to Part(C&B) using screws 1#.

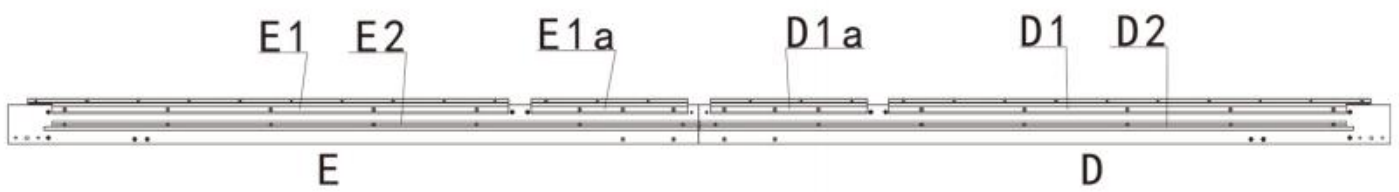
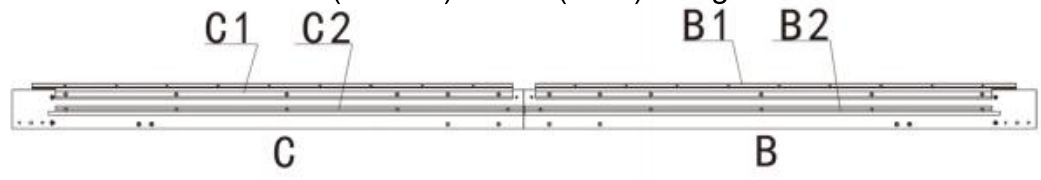

Attach Part (E1&E1a,D1&D1a) to Part(E&D) using screws 1#.



2#
x16



3#
x16

Step 4:

Connect poles and beams using screws (2&3) as shown.

Replicate four times.

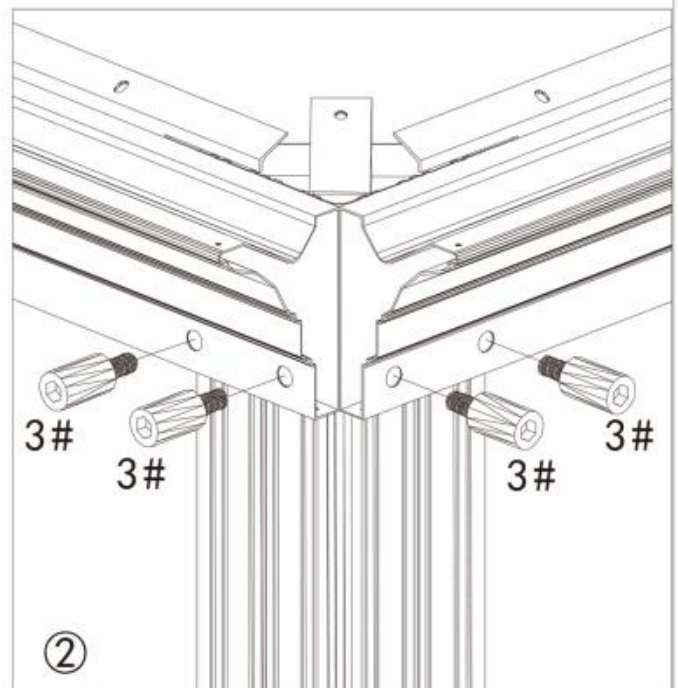
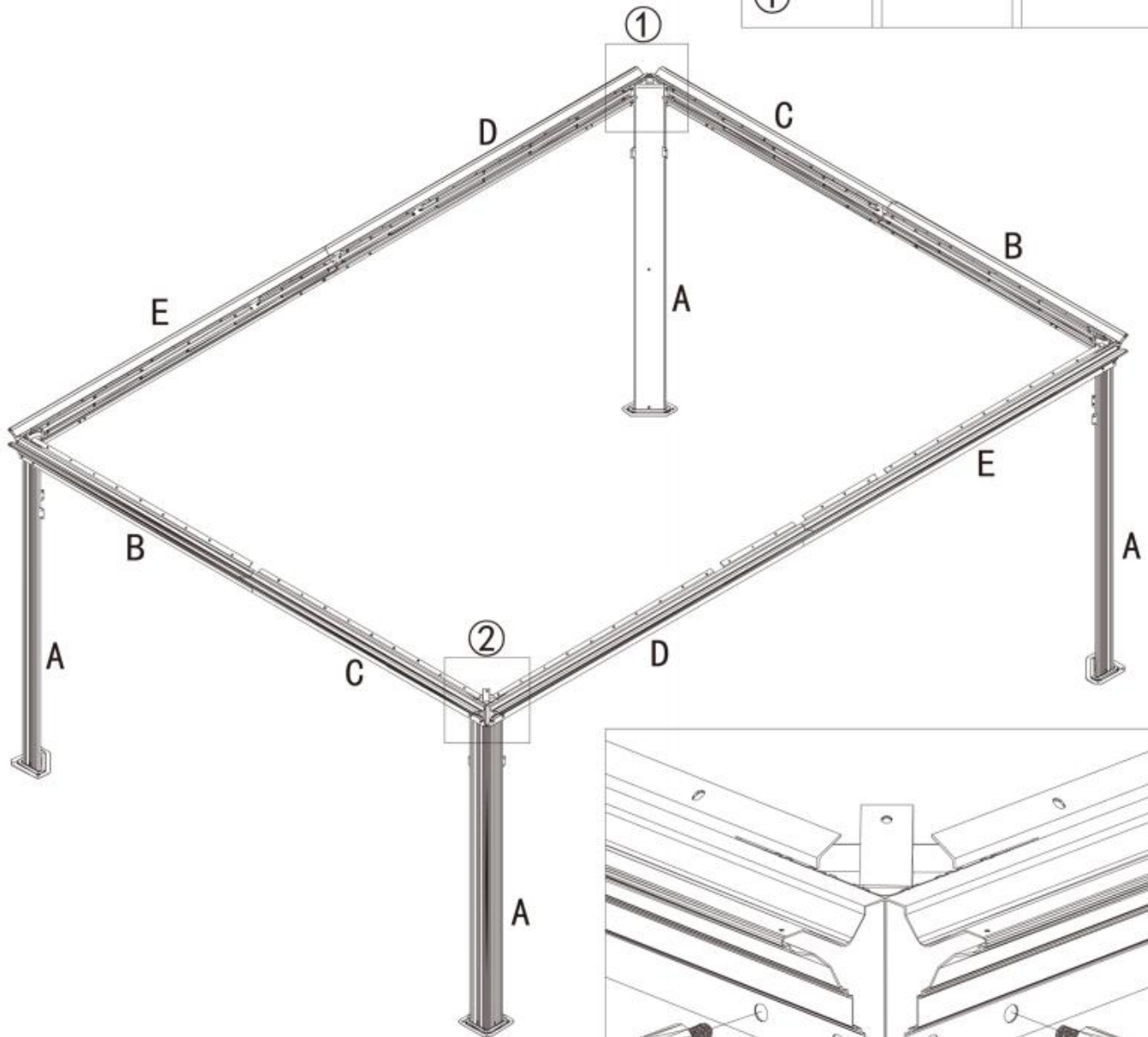
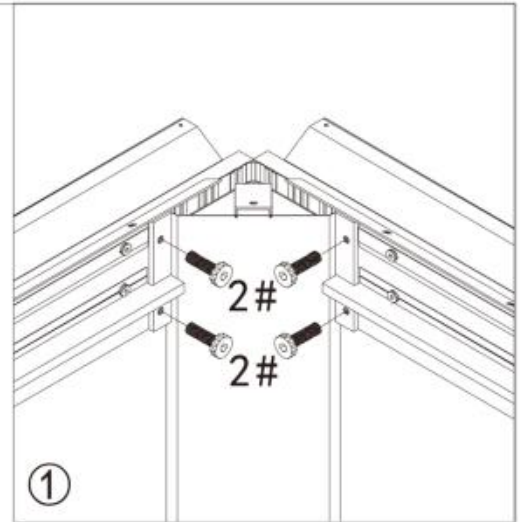

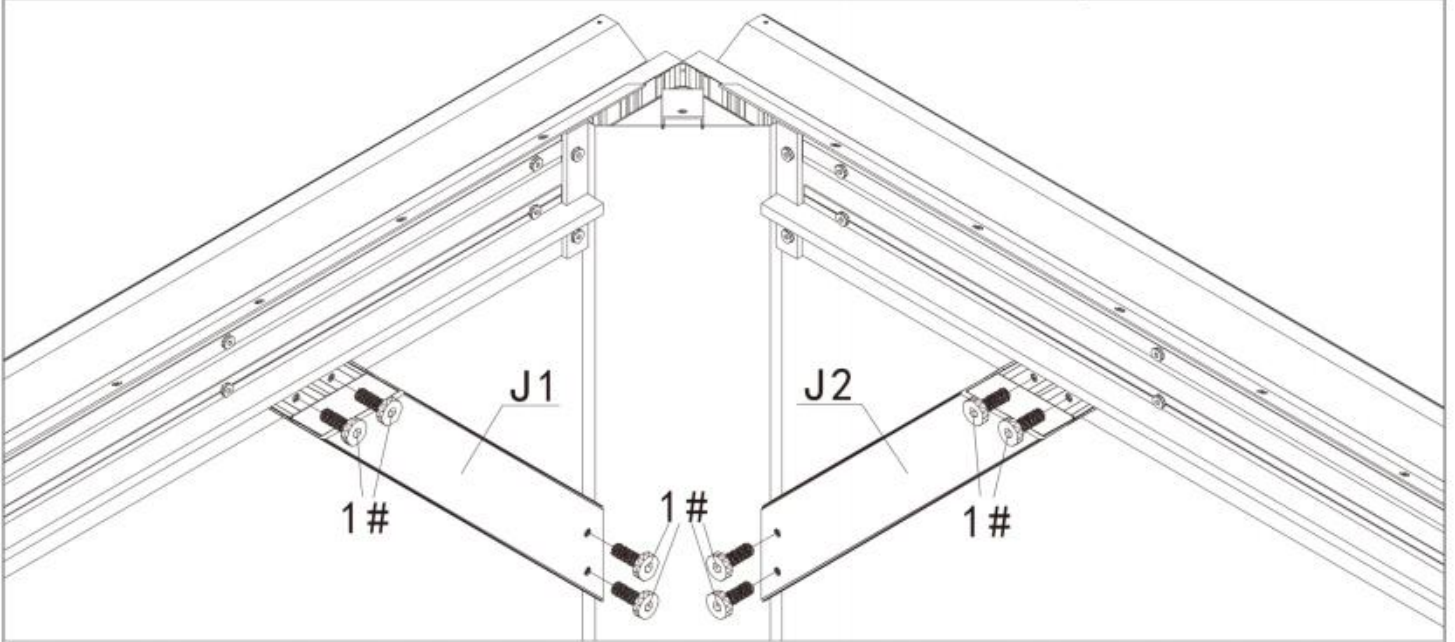
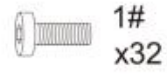

Step 5:

Affix Part (J1&J2) to the frame using screws 1#.

Replicate four times.

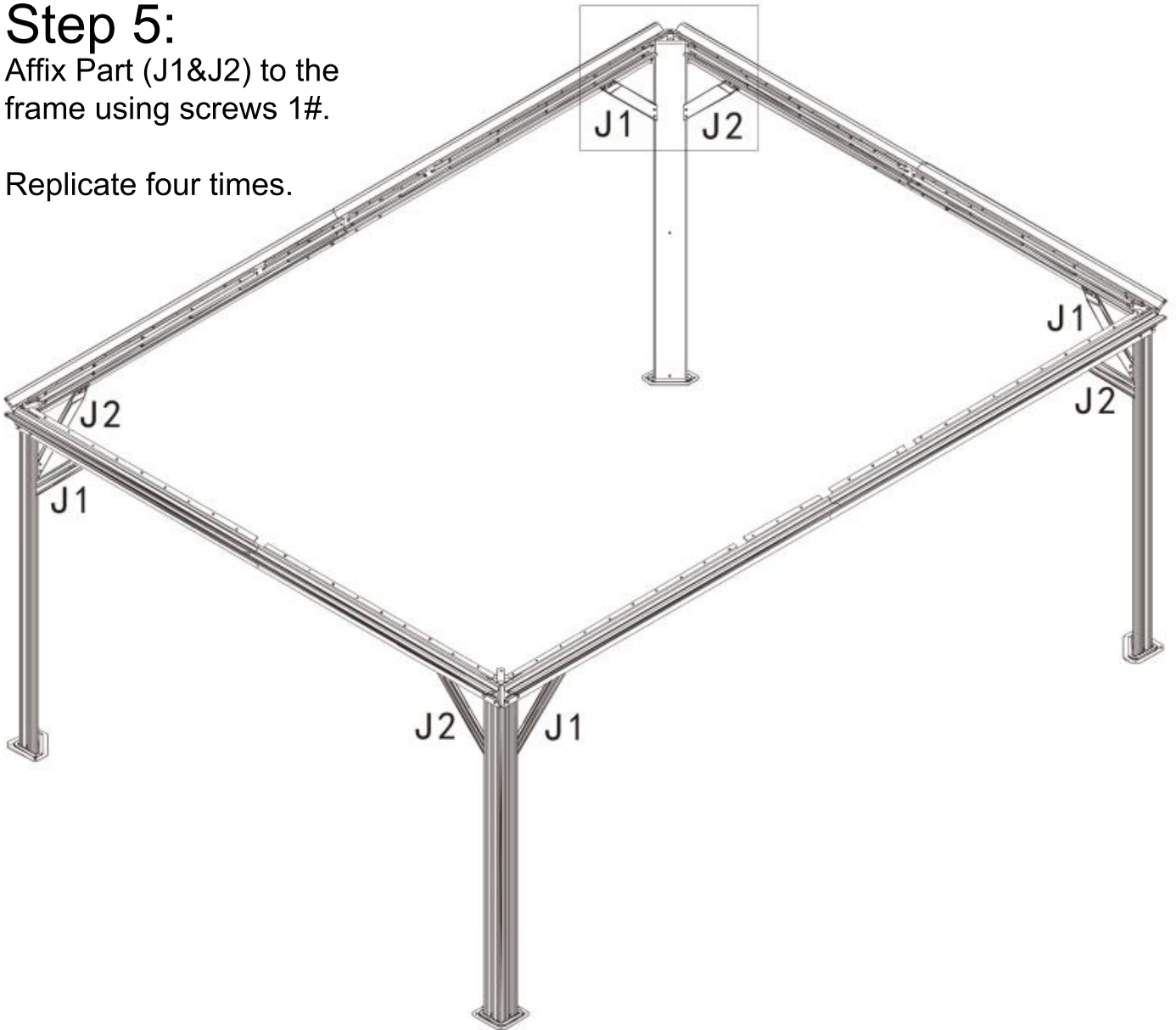



G (x4)



H (x4)



8#
x4



9#
x24



H2 (x1)

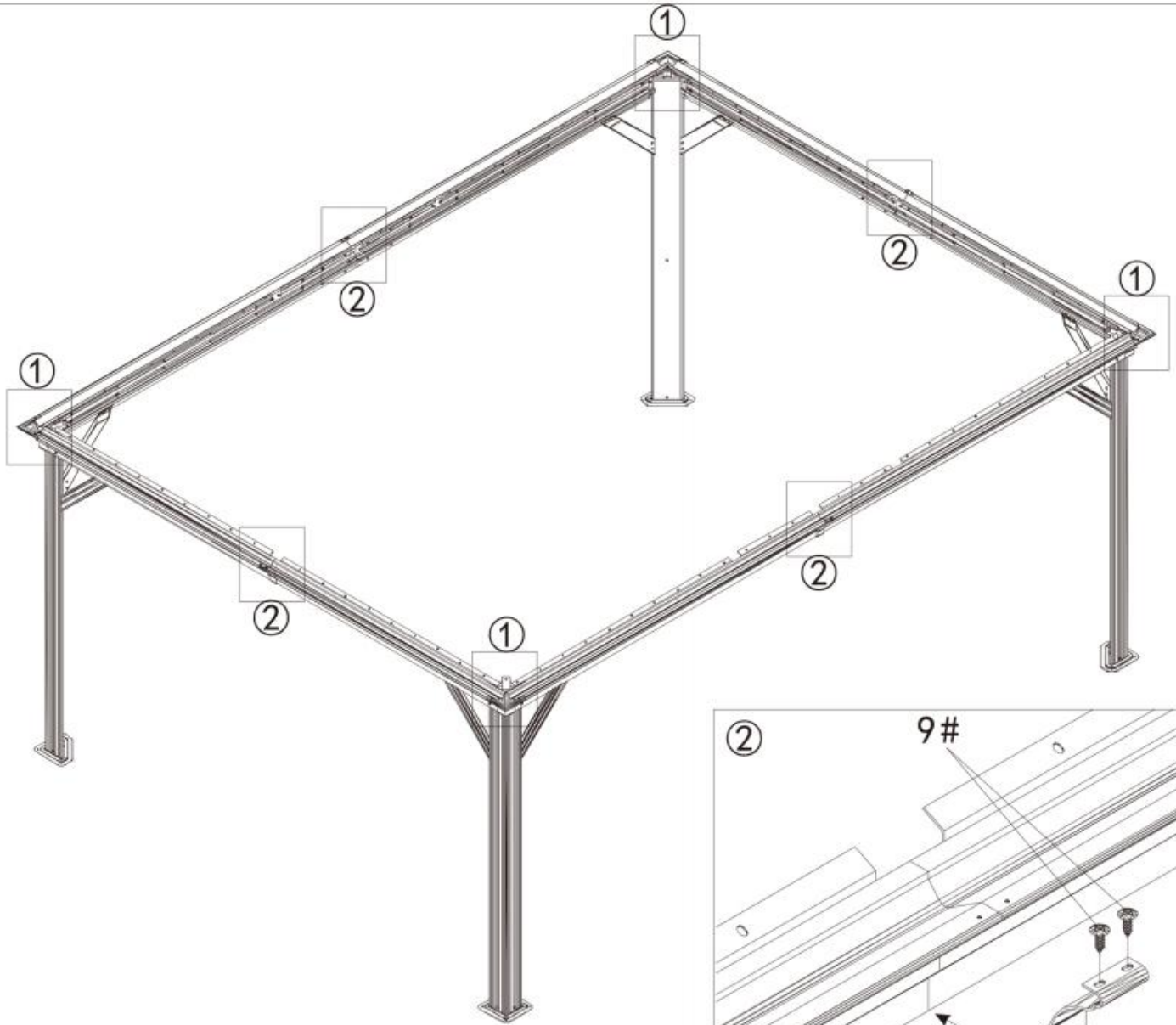

Step 6:

Cover four corners with Part G using screws 9#.

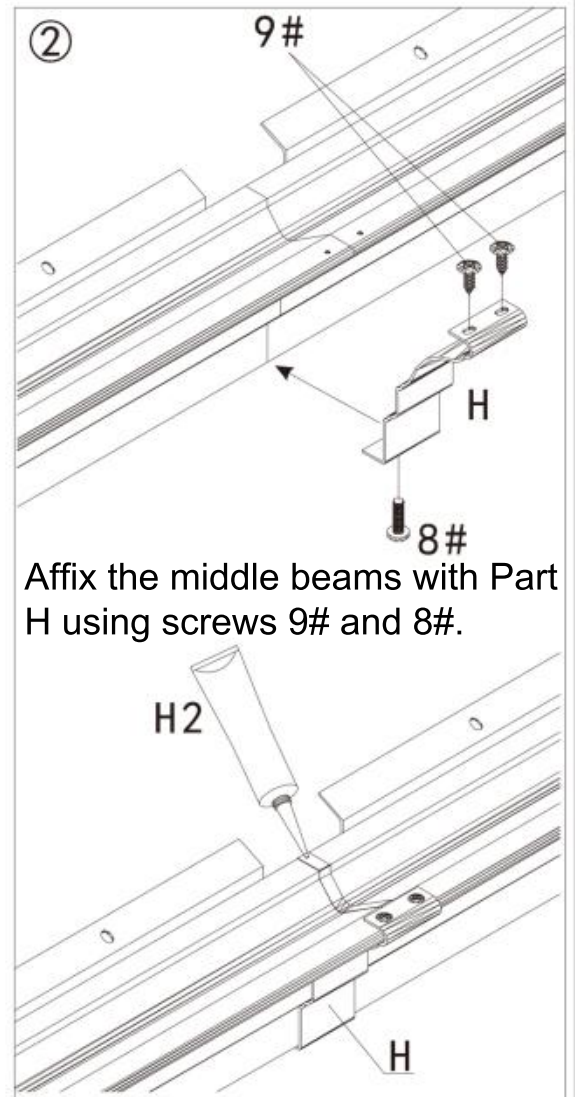
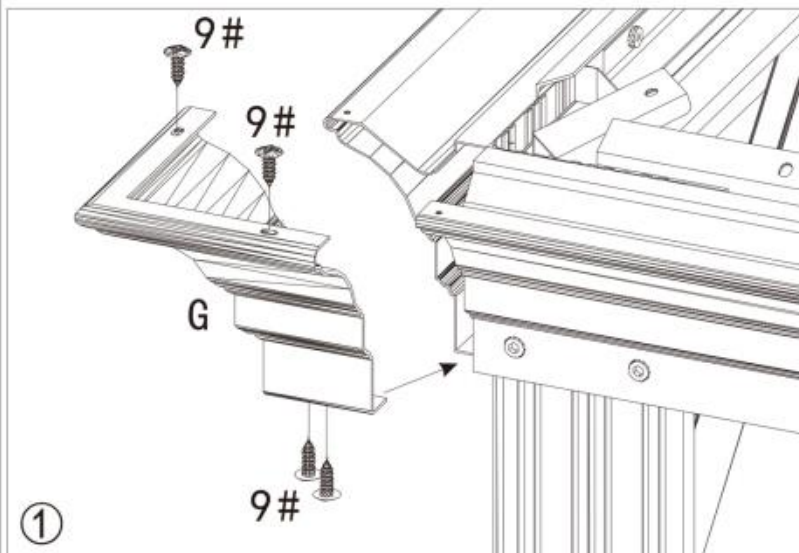

Affix the middle beams with Part H using screws 9# and 8#.

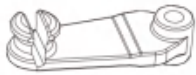

4#
x128



H1 (x4)

Step 7: Set up the hooks.

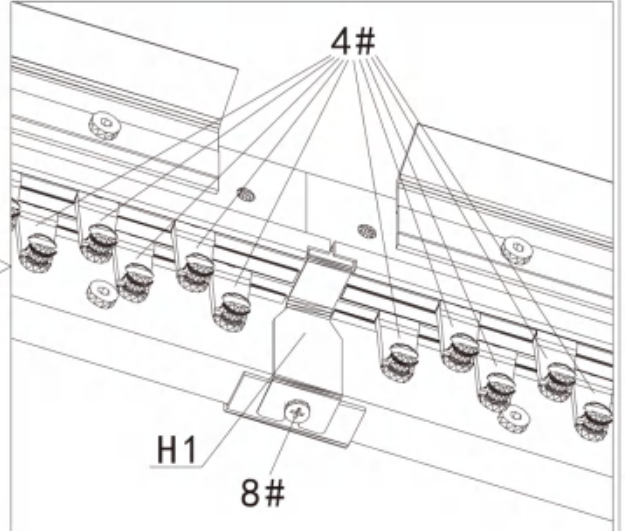
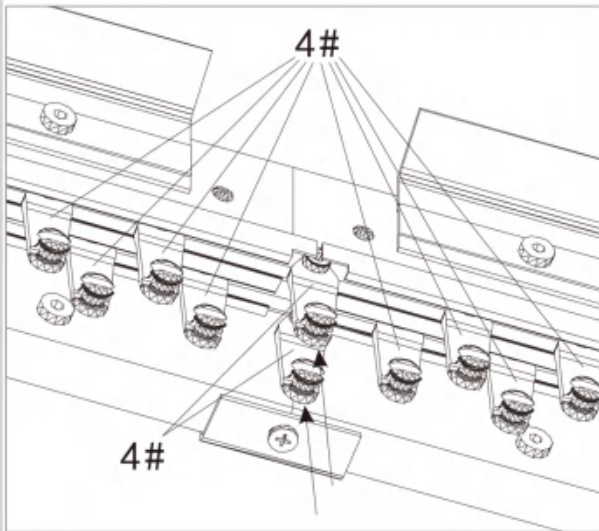
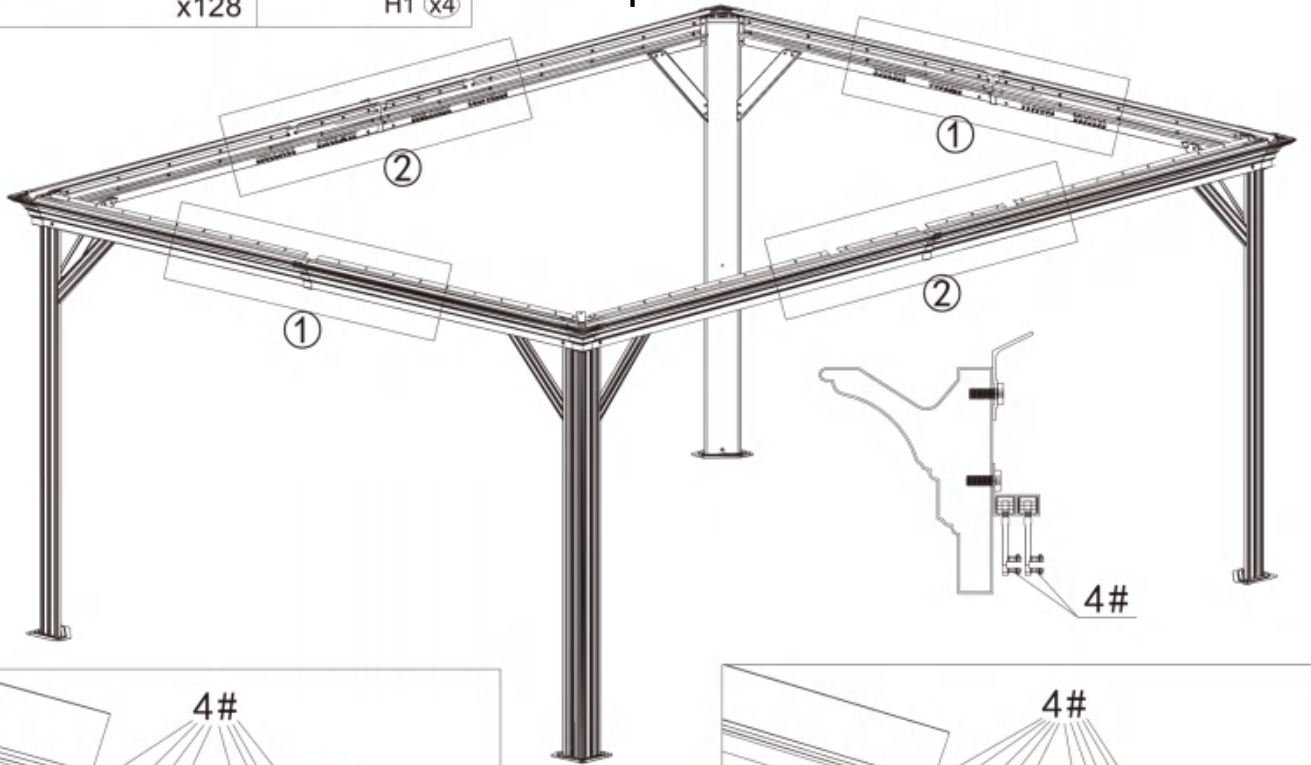

① Put 7 hooks to each sidewall track(Part C2&B2).Then put H1 to lock it using screws 8#.

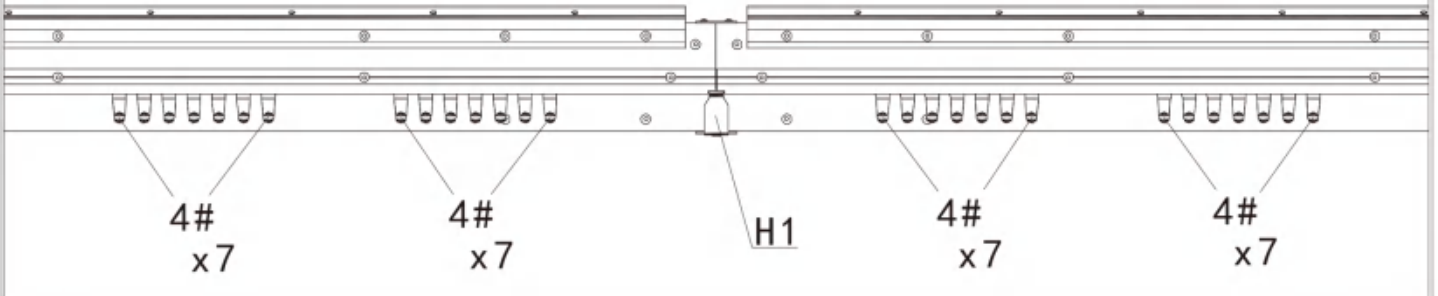

② Put 9 hooks to each sidewall track(Part E2&D2).Then put H1 to lock it using screws 8#.

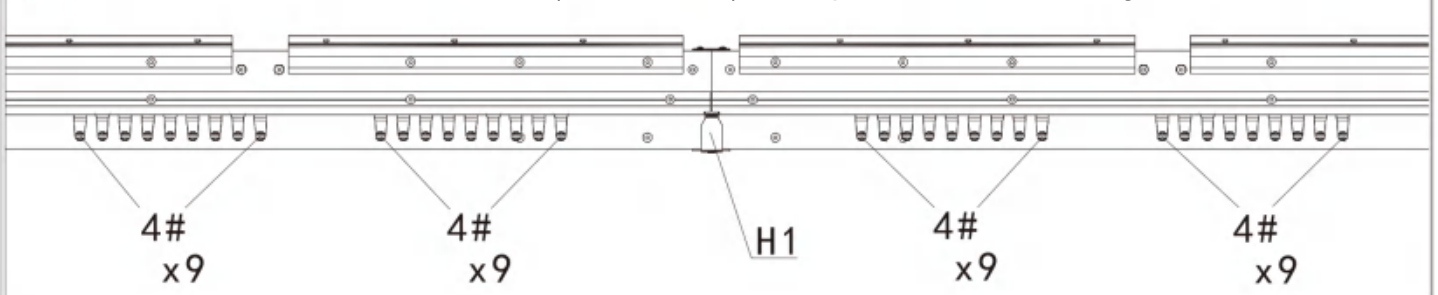



K x1



M x4



P x2



Q x2



R x4



1#
x16

Step 8: Set up roof frame

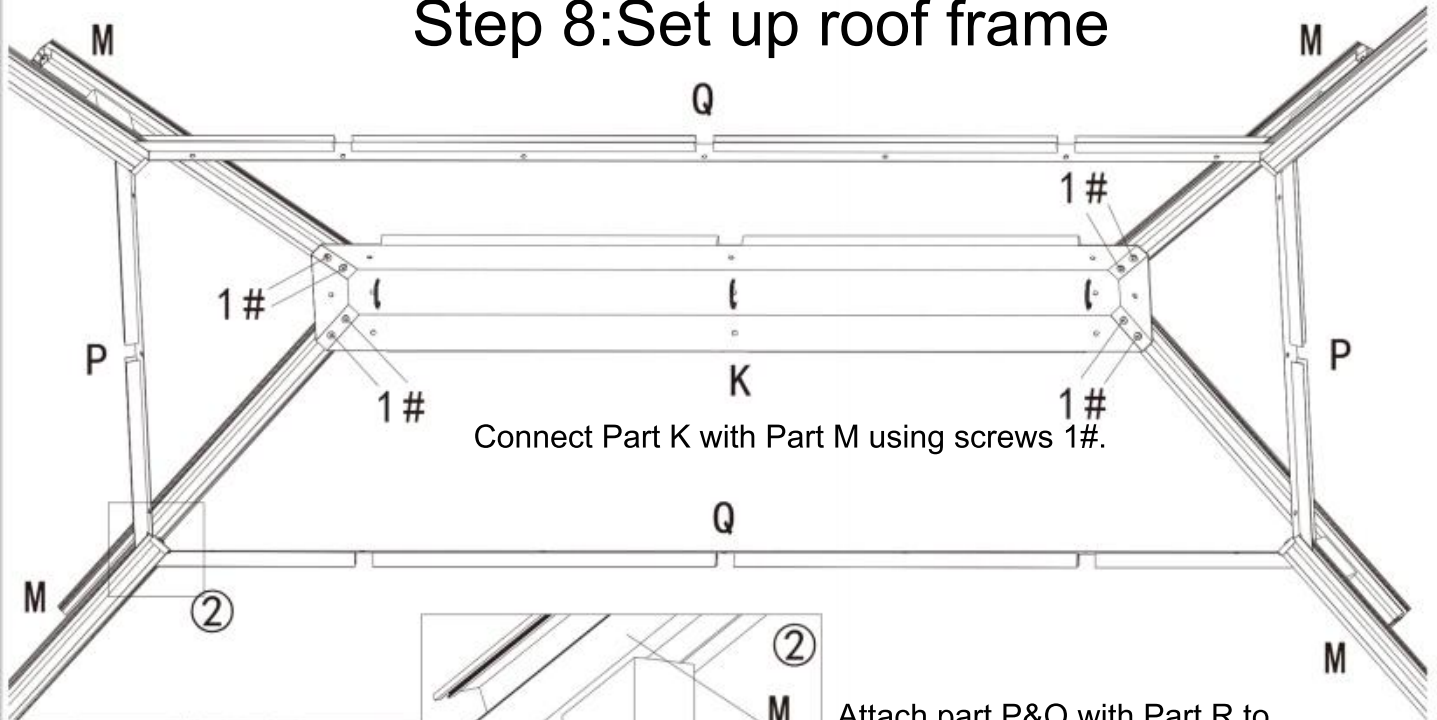

Connect Part K with Part M using screws 1#.

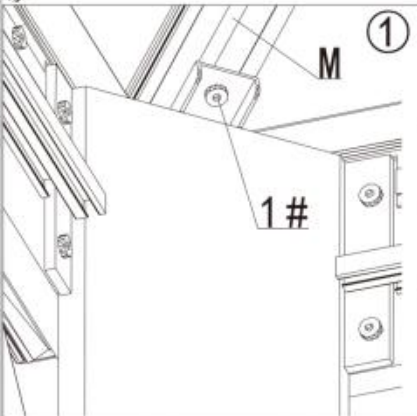

Attach Part M to the main frame using screws 1#.

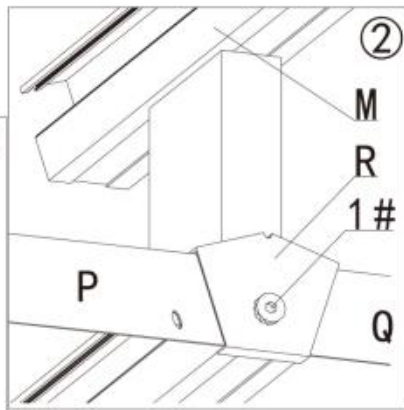

Attach part P&Q with Part R to part M using screws 1# .

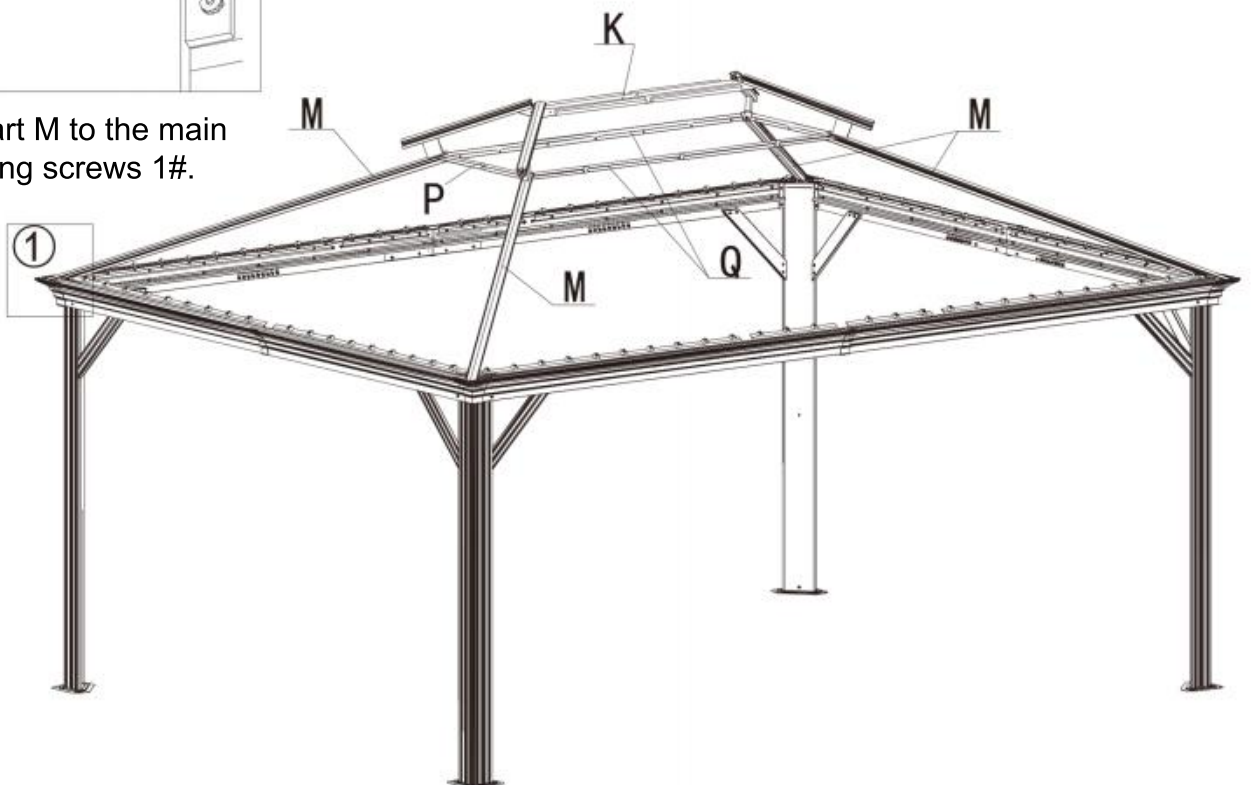

Parts Required:

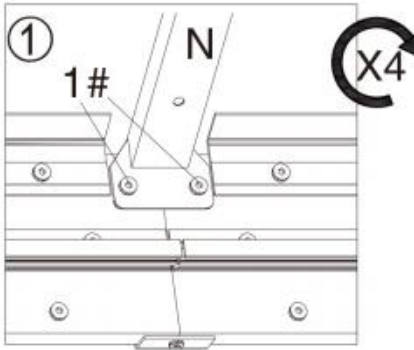
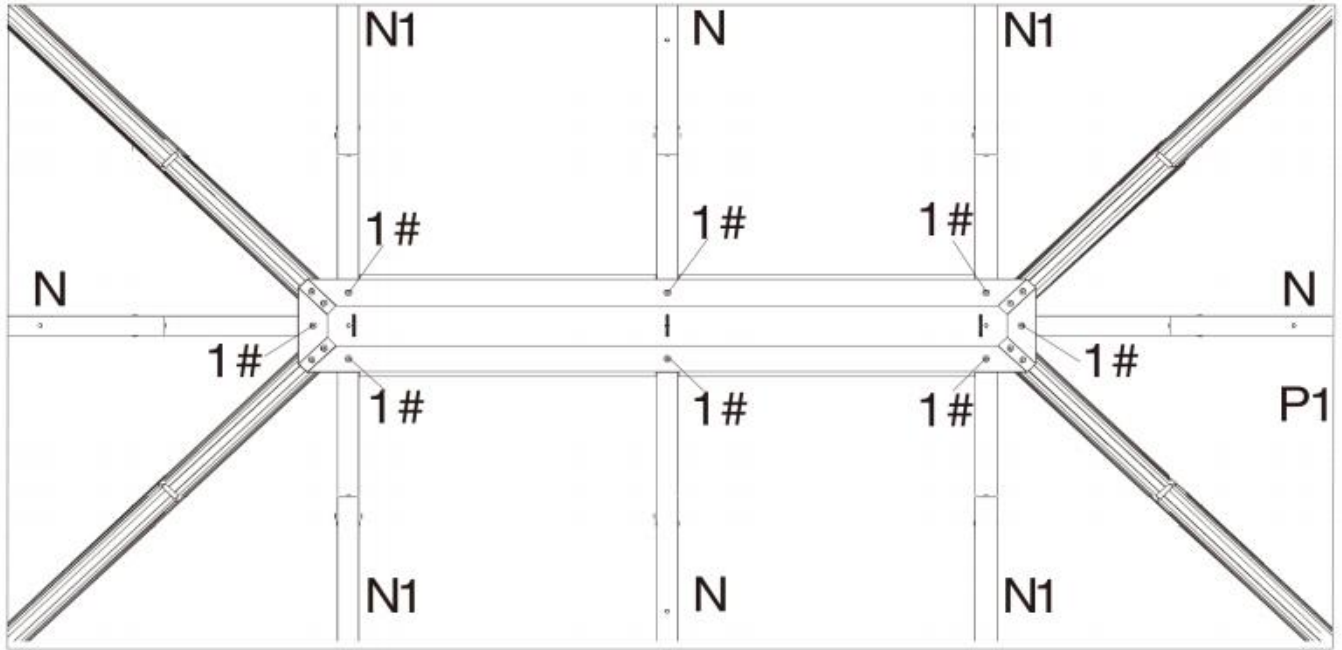
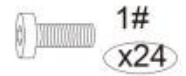
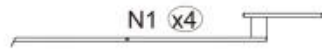
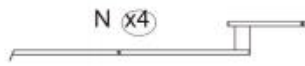

Step 9:

Attach roof bar (Part N&N1) to main frame using screw 1#.

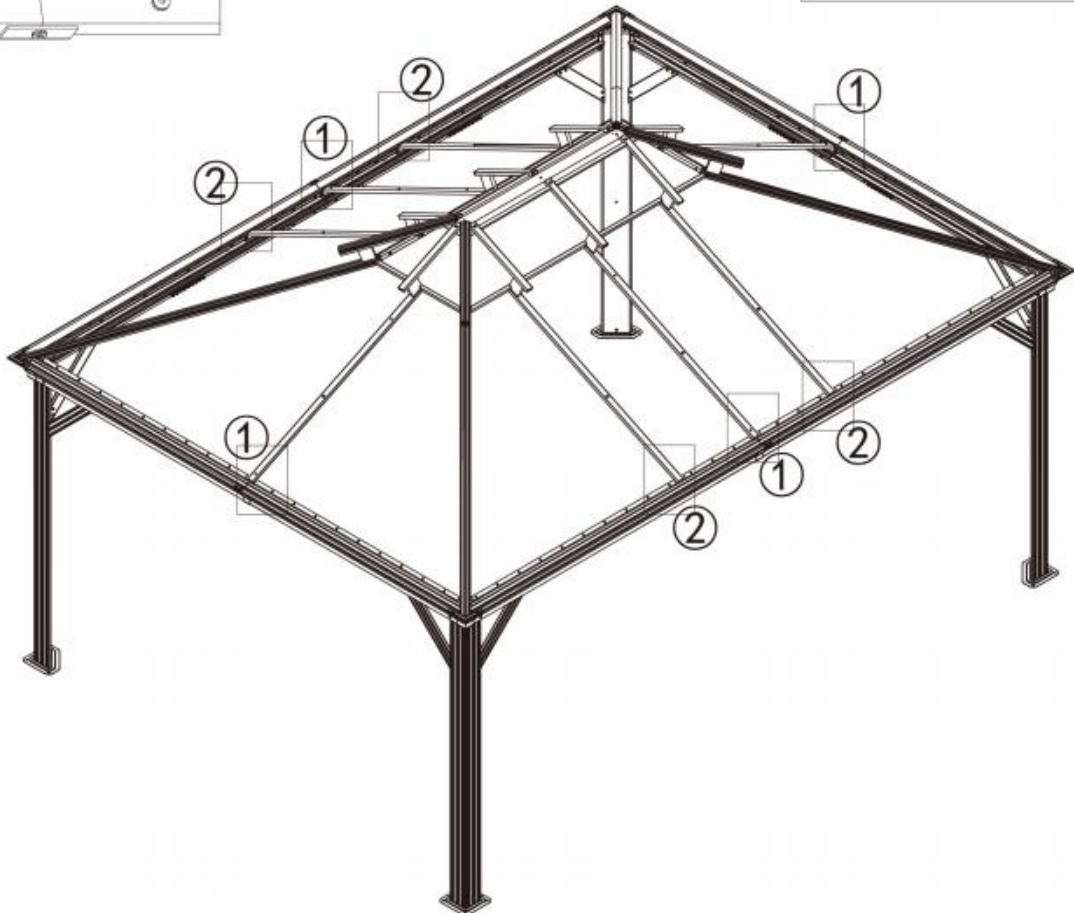
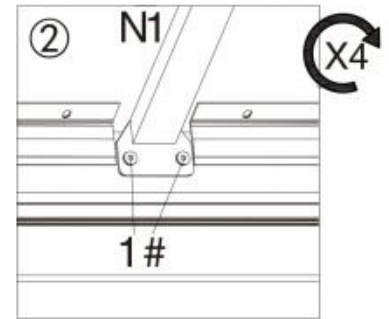

Parts Required:

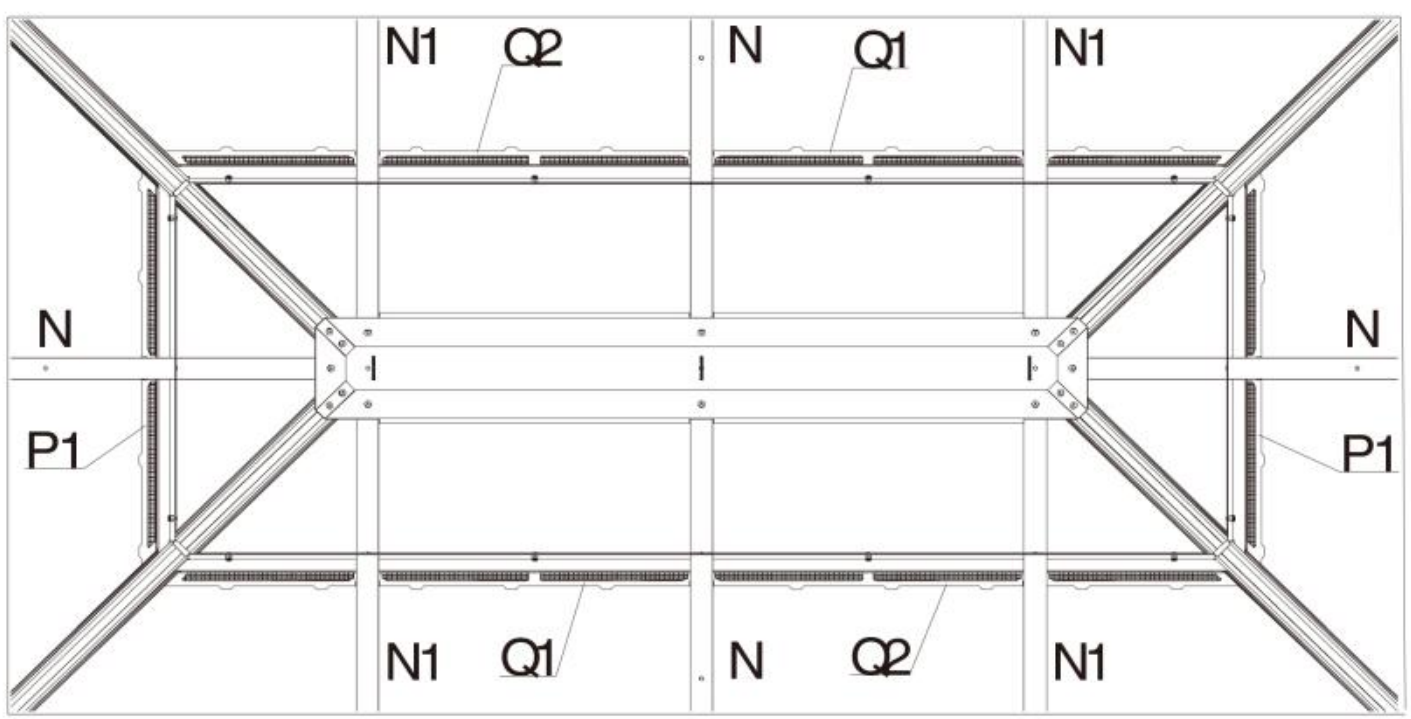
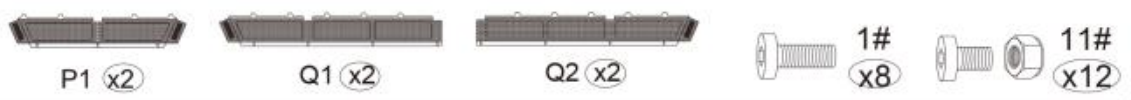

Step 10:

Attach net frames (Part P1,Q1&Q2) to finishing bars (Part P &Q) using screws 1#&11# as shown in diagram.

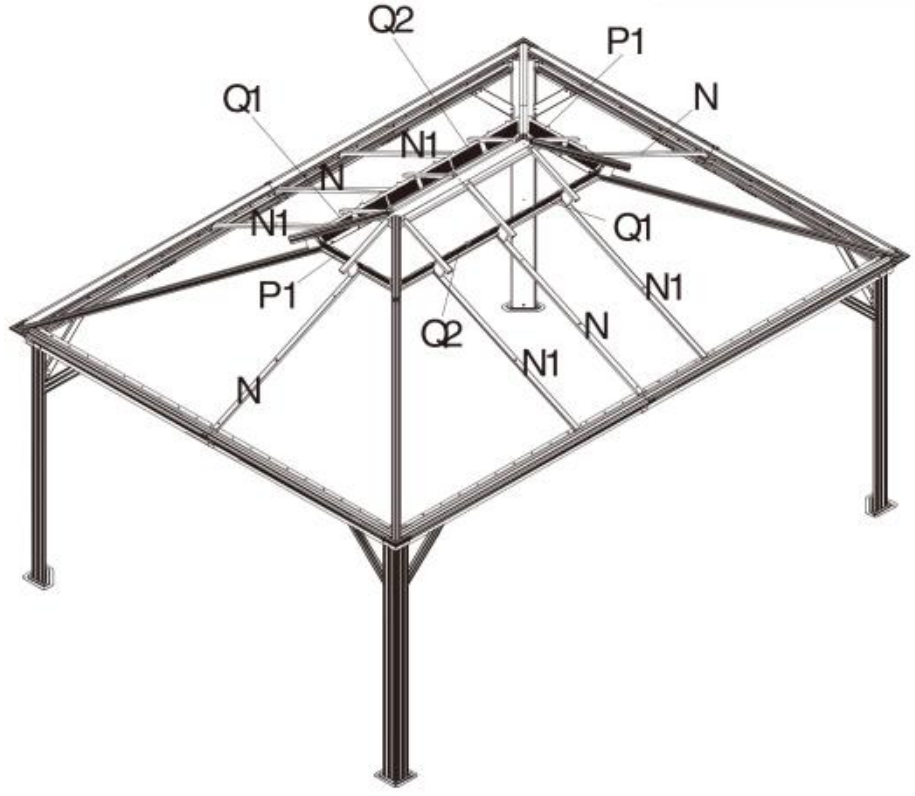
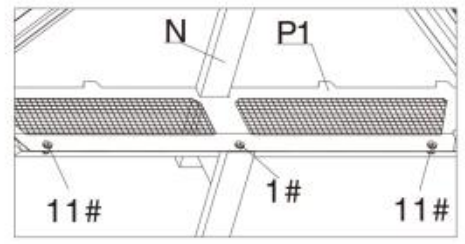
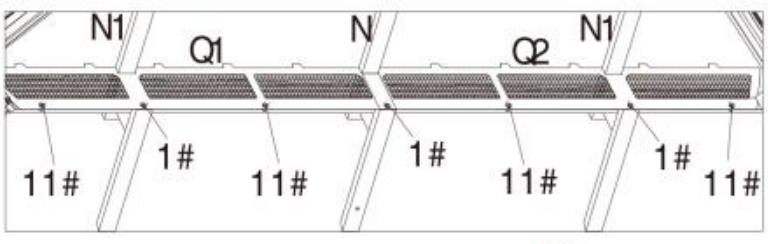



K1 (x1)



1#
x3

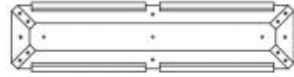

Kx1

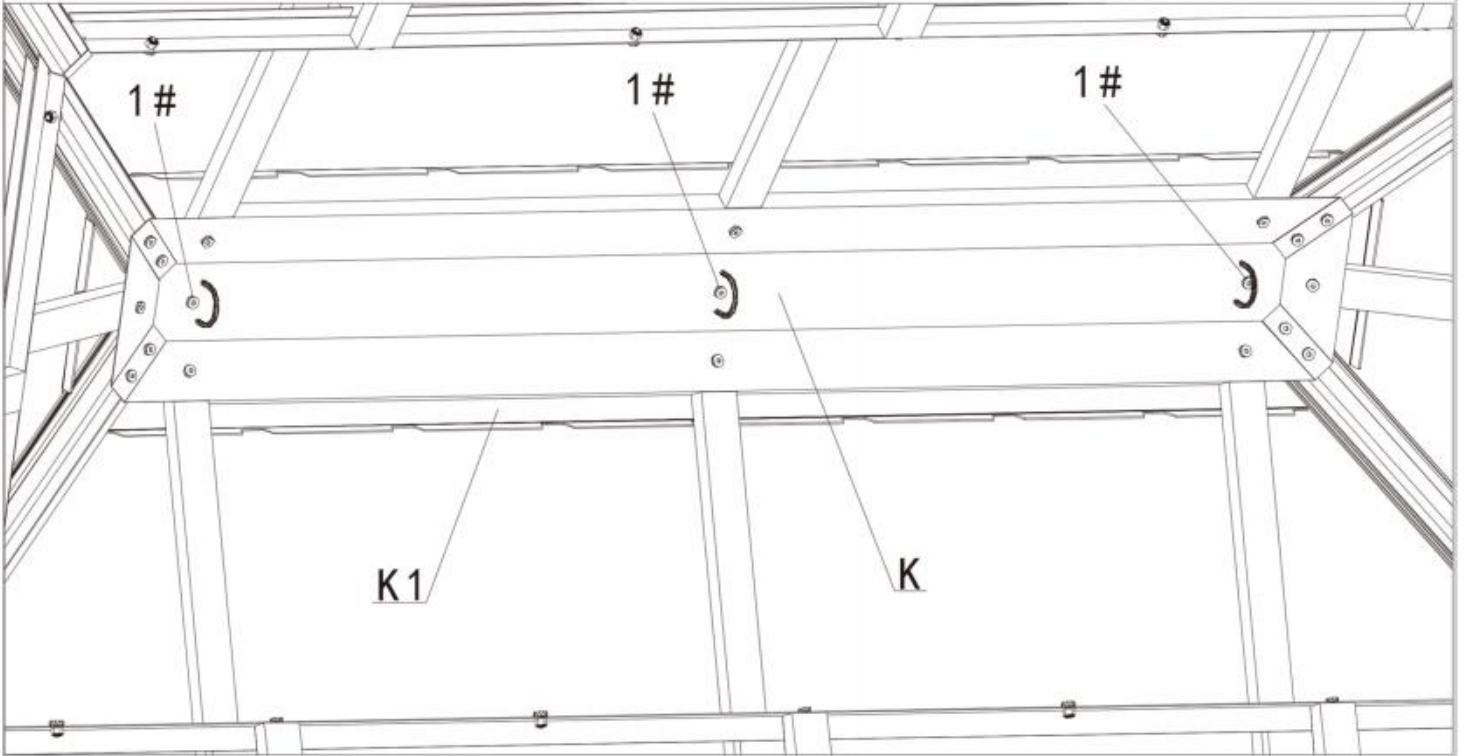

Connect Part K1 to Part K using screw 1#.

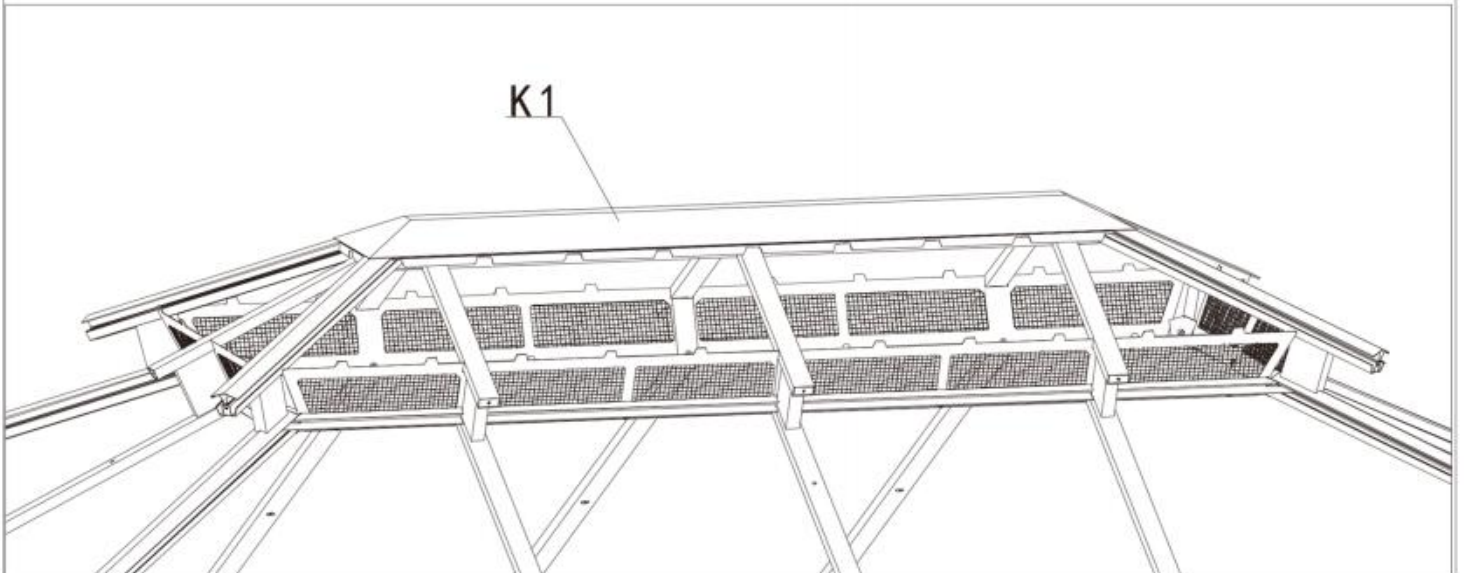

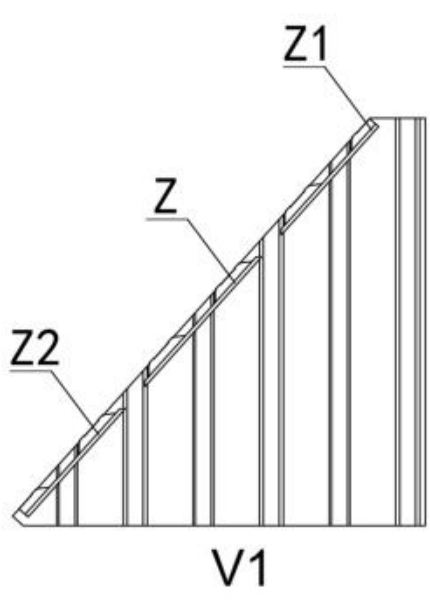
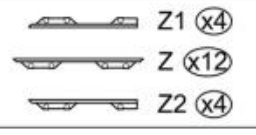
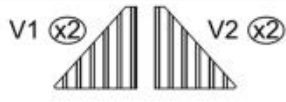

Step 11:
Cover Part Z,Z1&Z2 to roof panels.

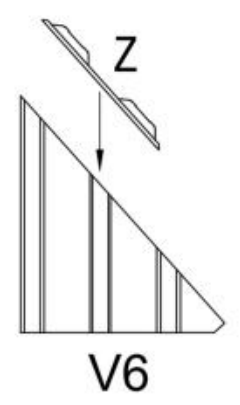
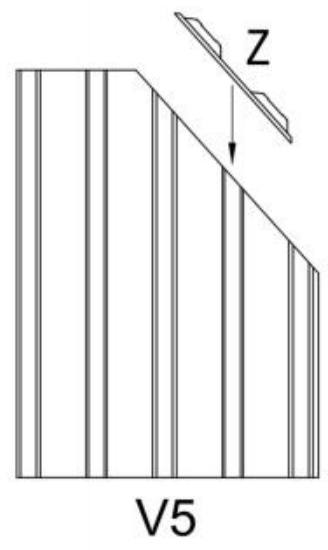
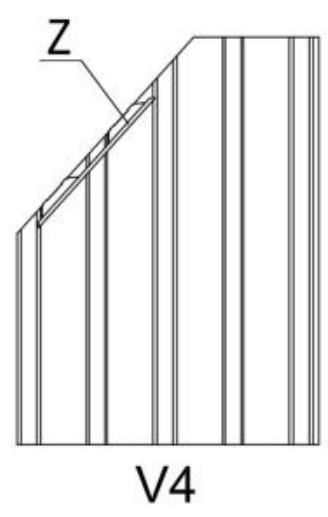
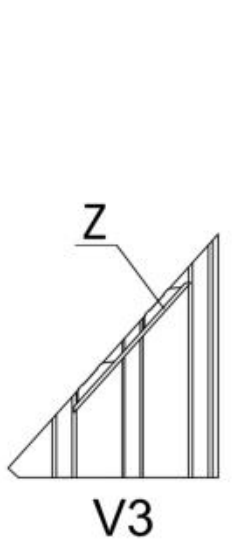
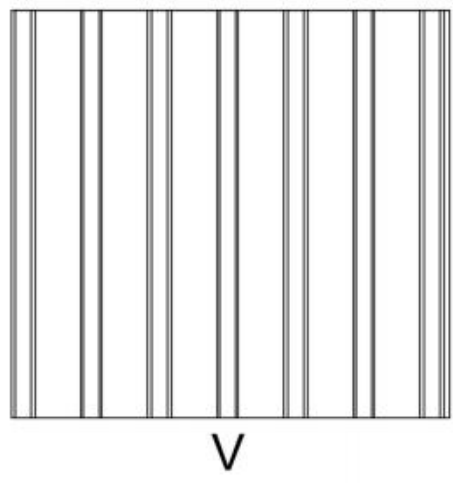
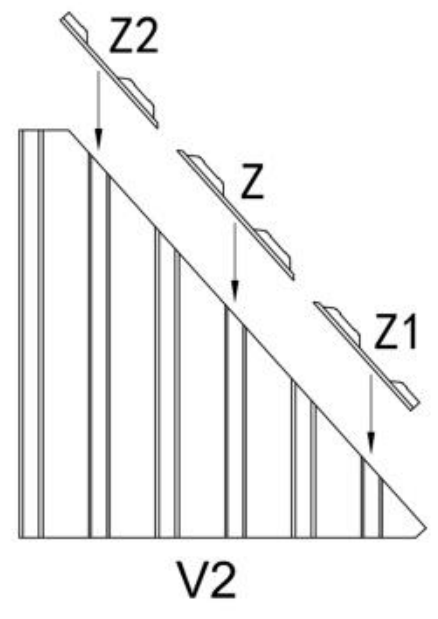

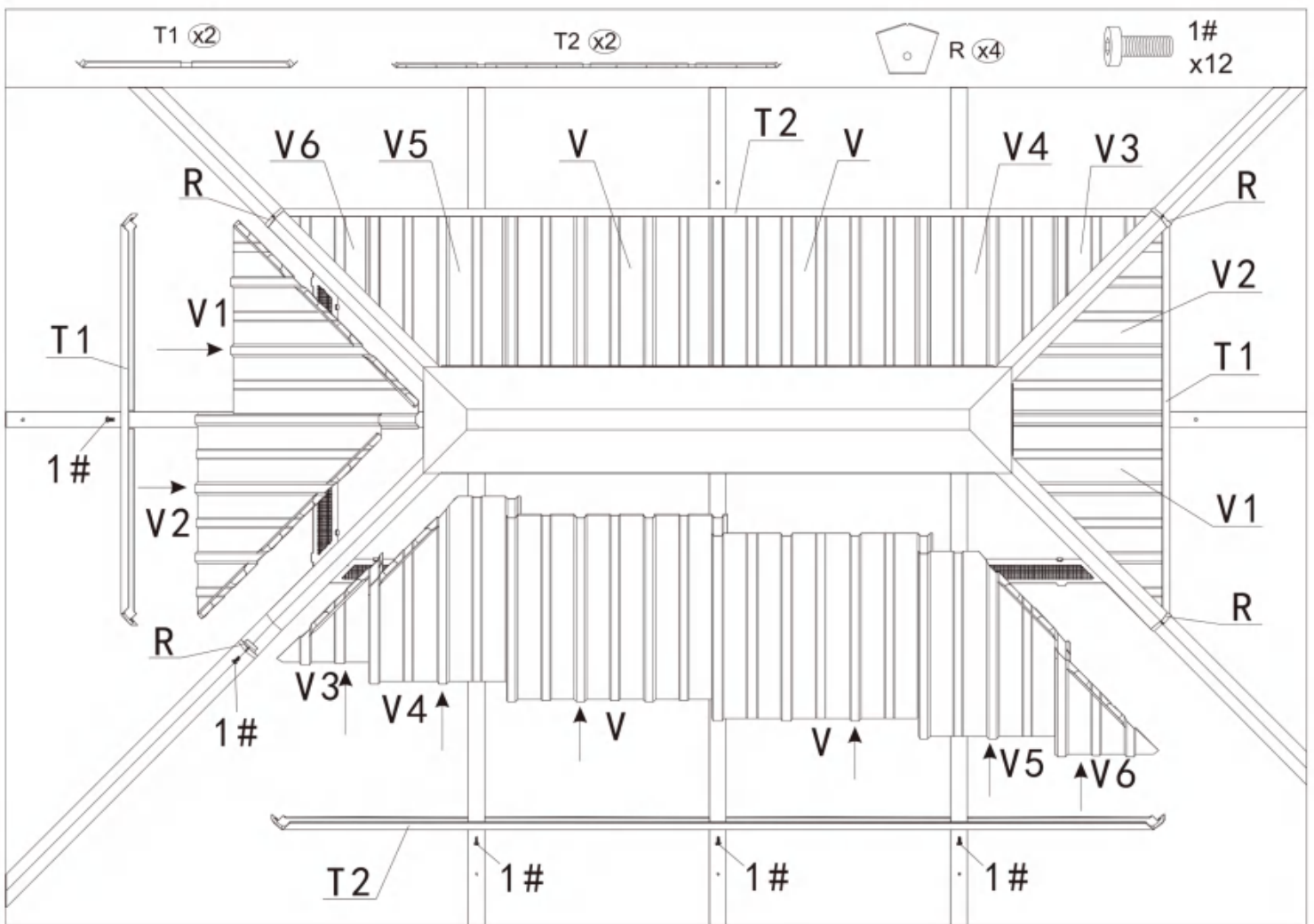

Step 12:

Push Part (V,V1,V2,V3,V4,V5,V6)
to upper roof.

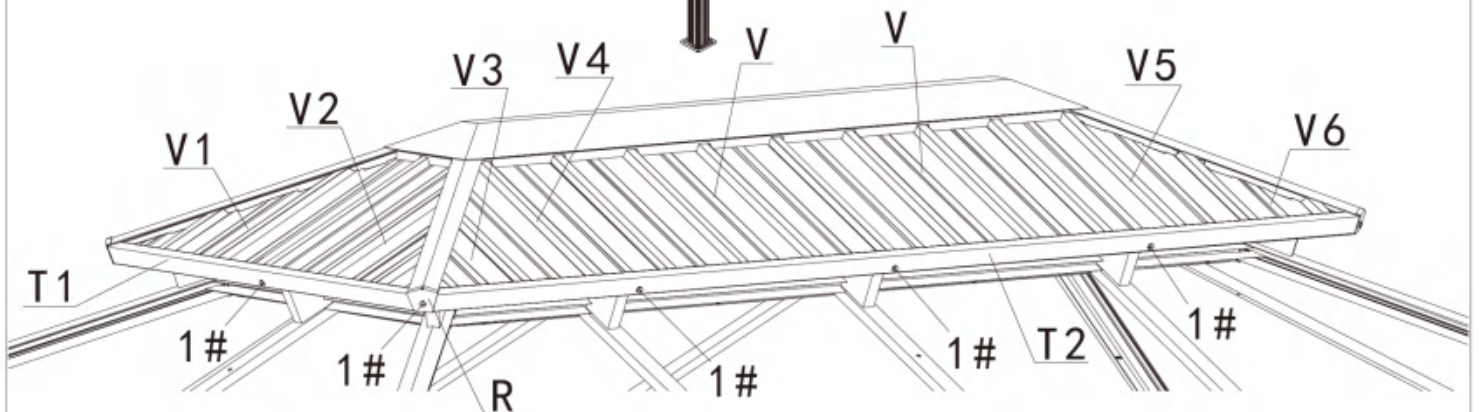
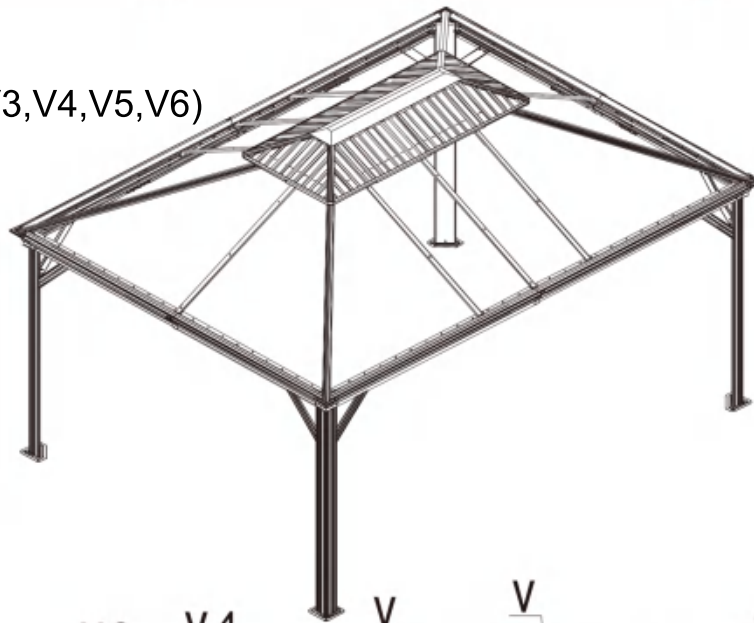

Attach Part T1&T2 to upper roof with
Part R using screws 1#.

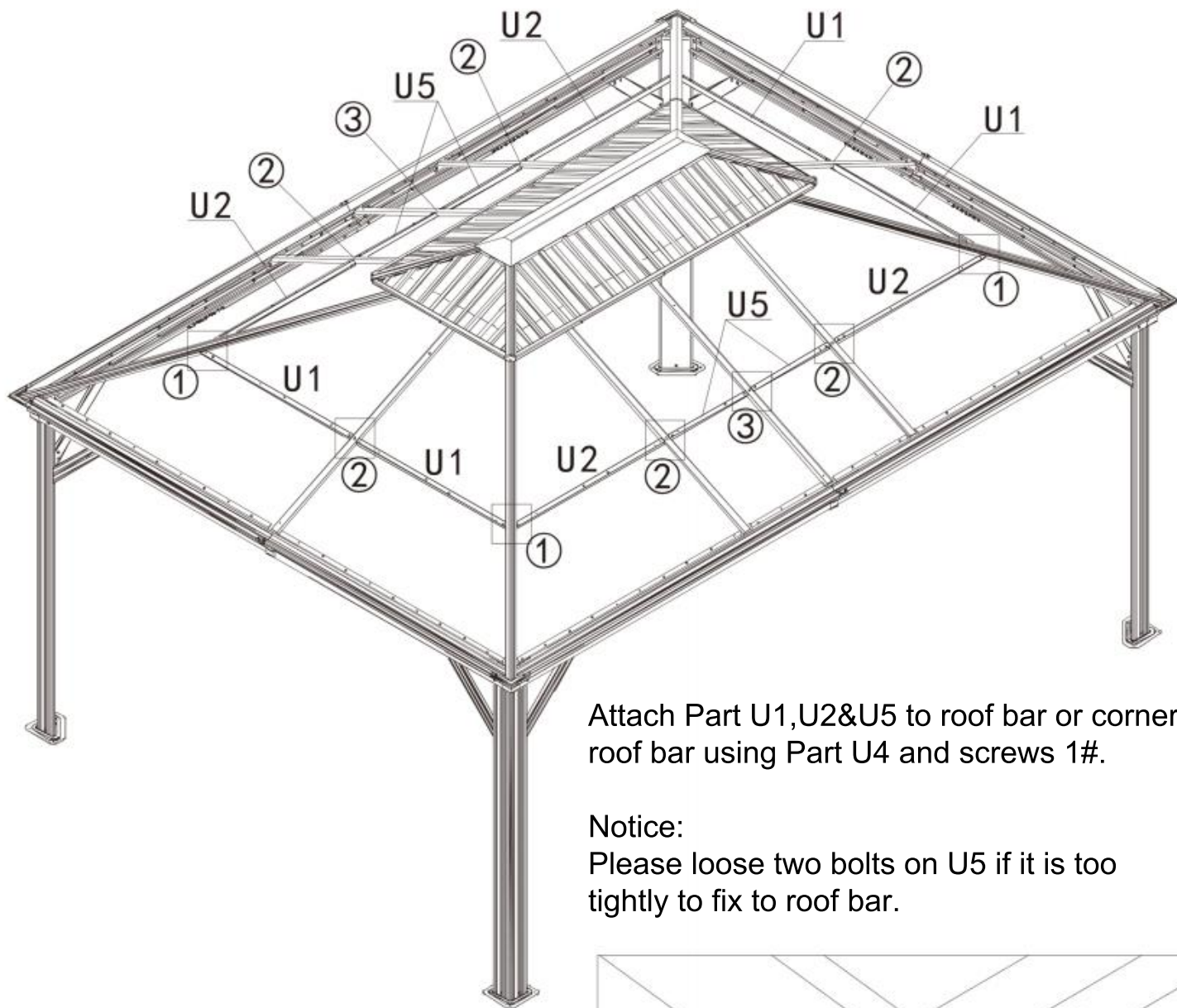

Attach Part U1,U2&U5 to roof bar or corner roof bar using Part U4 and screws 1#.

Notice:
Please loose two bolts on U5 if it is too tightly to fix to roof bar.

Step 13:

Affix Part U1,U2&U5 to corner bar using Part U3 and screw 1#.

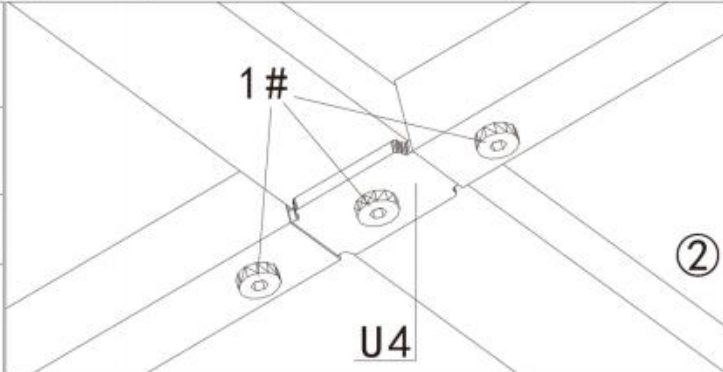
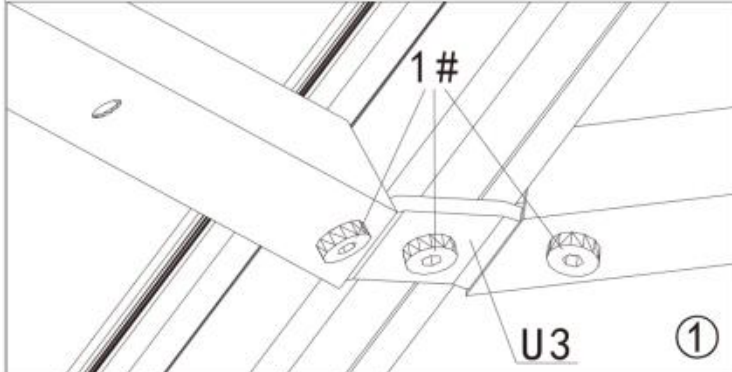
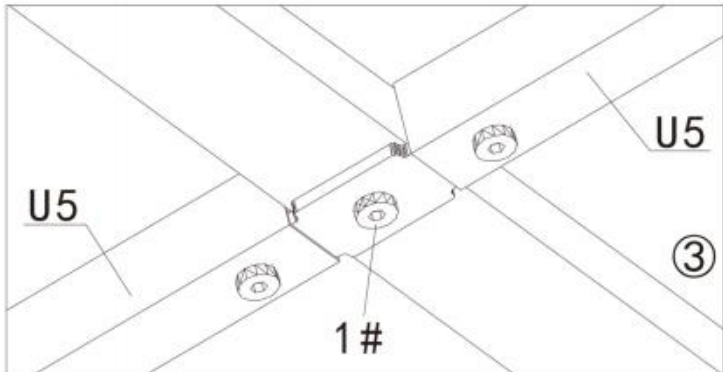

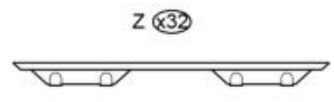
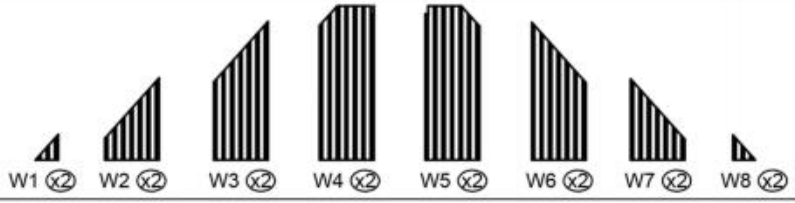

Step 14:
Cover Part Z to roof panels.

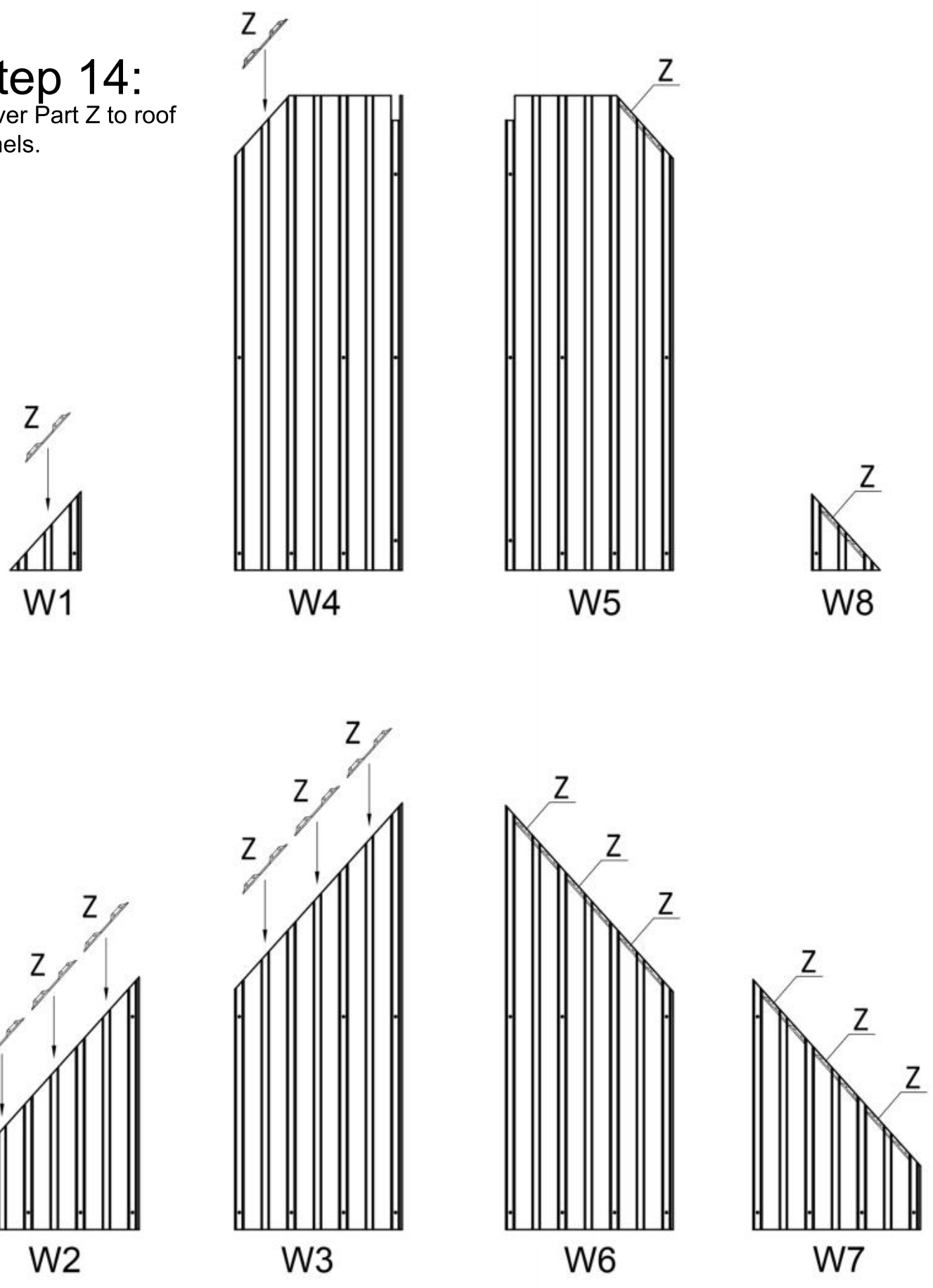

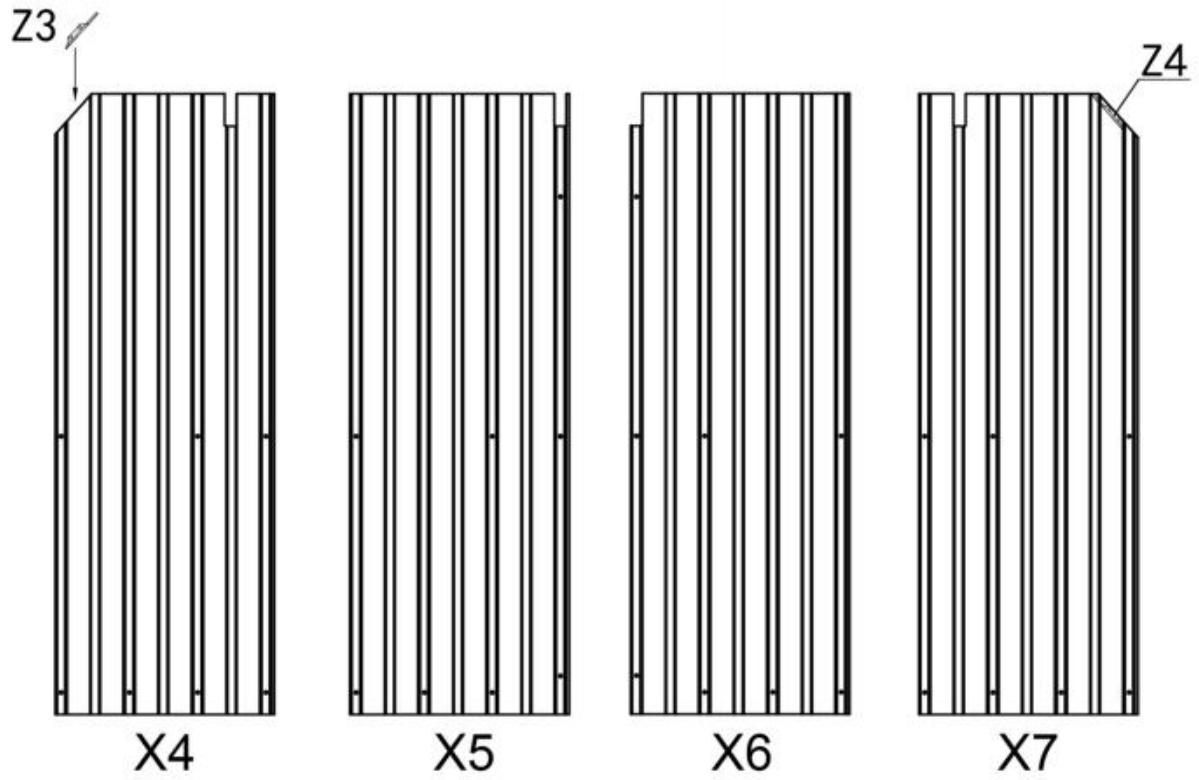
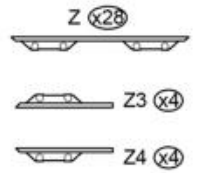
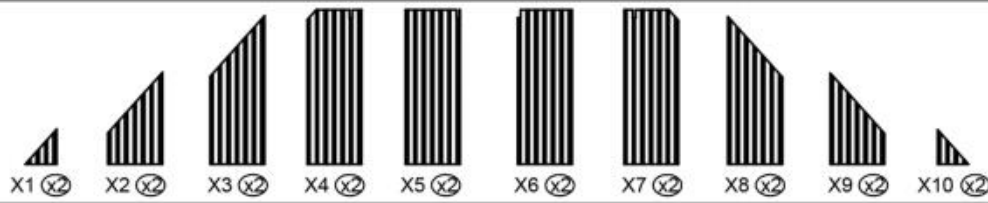

Step 15:

Cover Part Z,Z3,Z4 to roof panel.

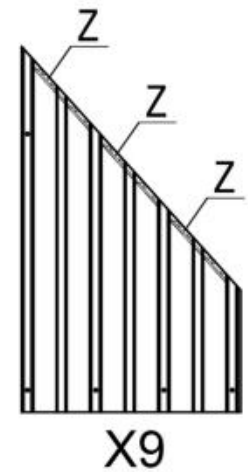
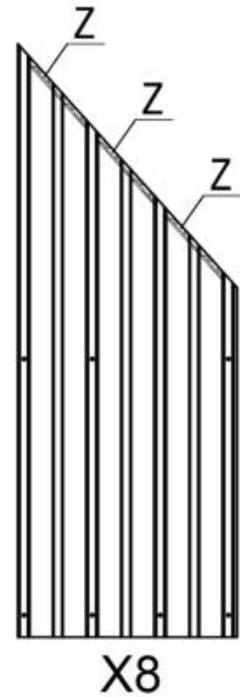
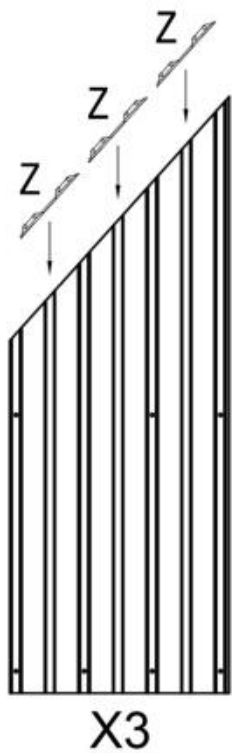
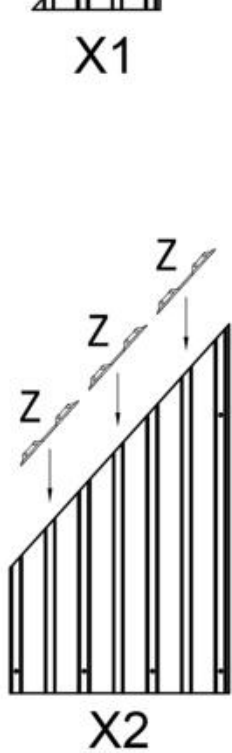
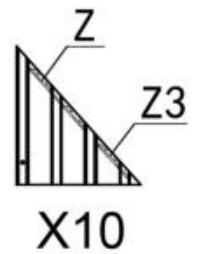

Overall roof assembly:

Please put the panels on the frame anti-clockwisely

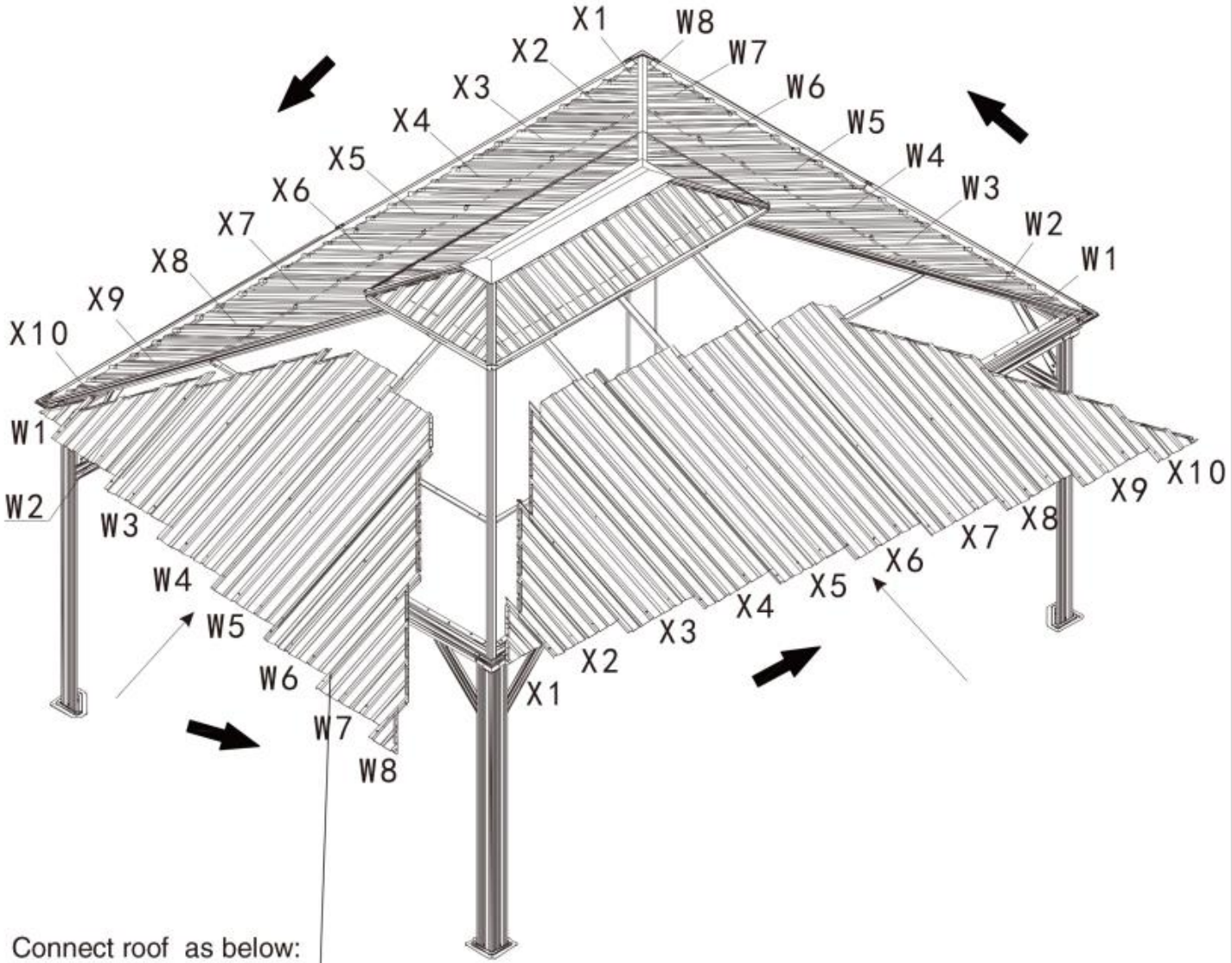

Connect roof as below:

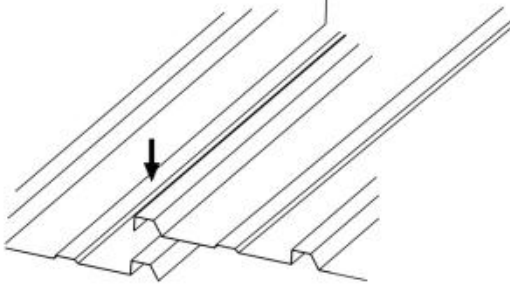

S x136

5# x84

6# x8

7# x40

10# x4

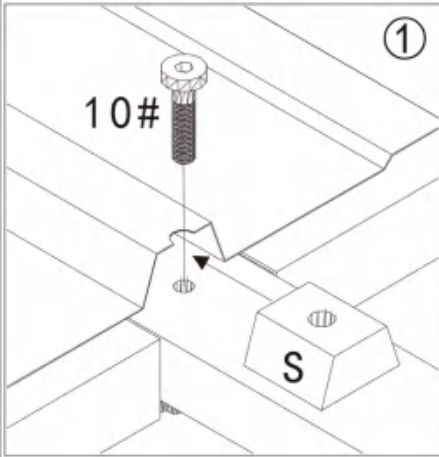

Step 16:

Affix roof panels using screws and Part S.

Notice:
Put on one roof panel and fasten it accordingly before attaching

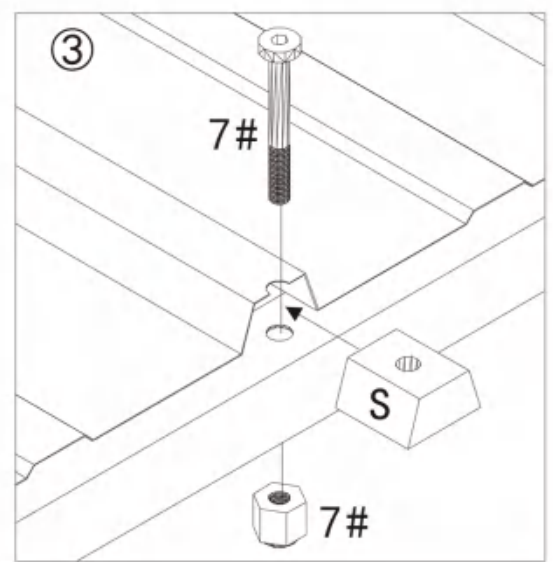
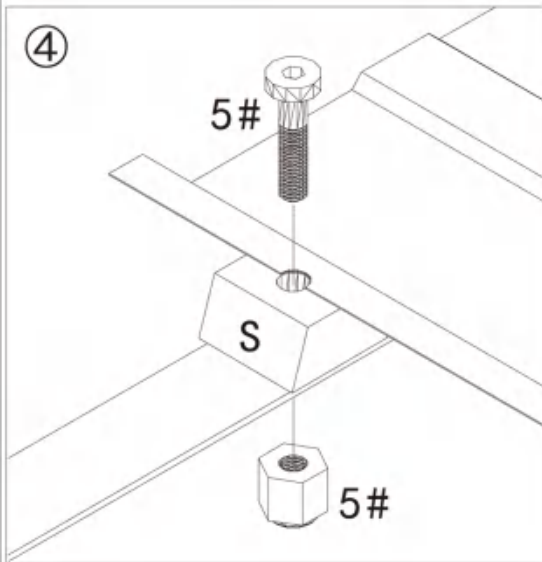
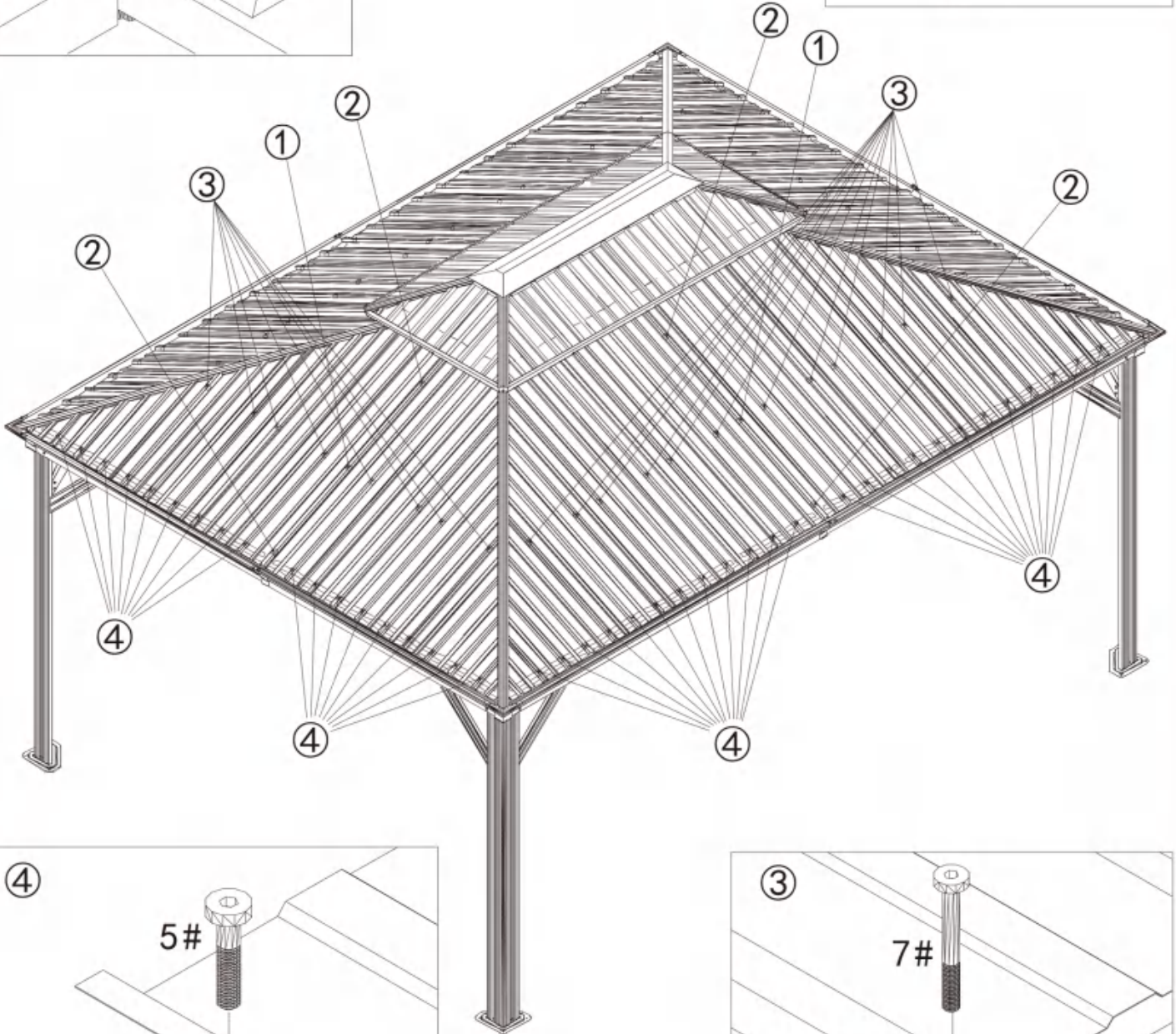
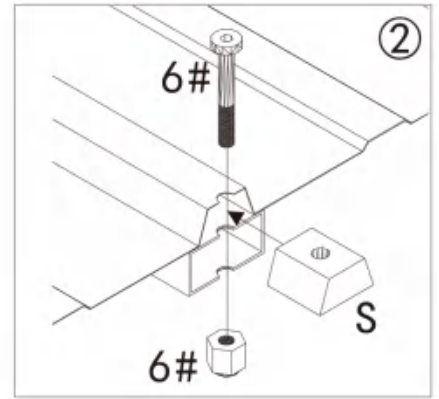

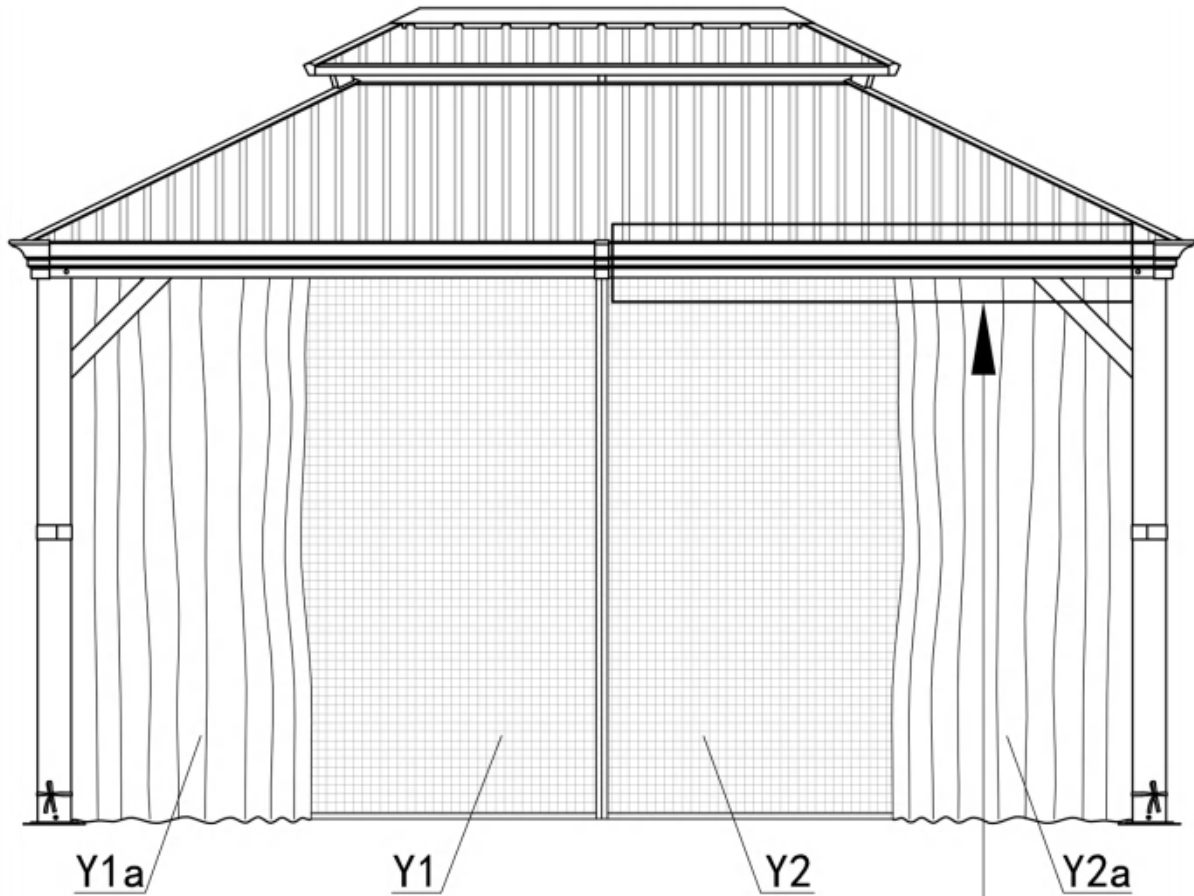
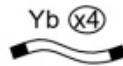
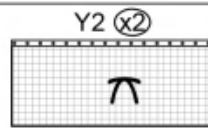
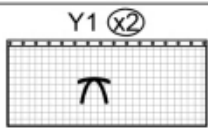

Step 17:

Hang up Mosquito Sidewalls and Solid Sidewalls.

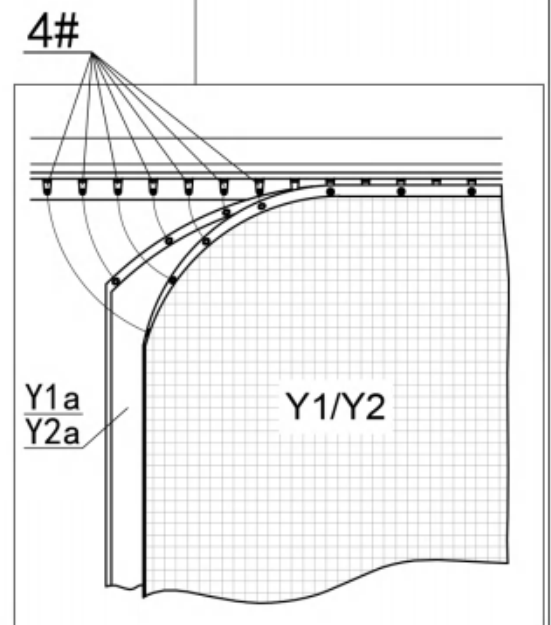
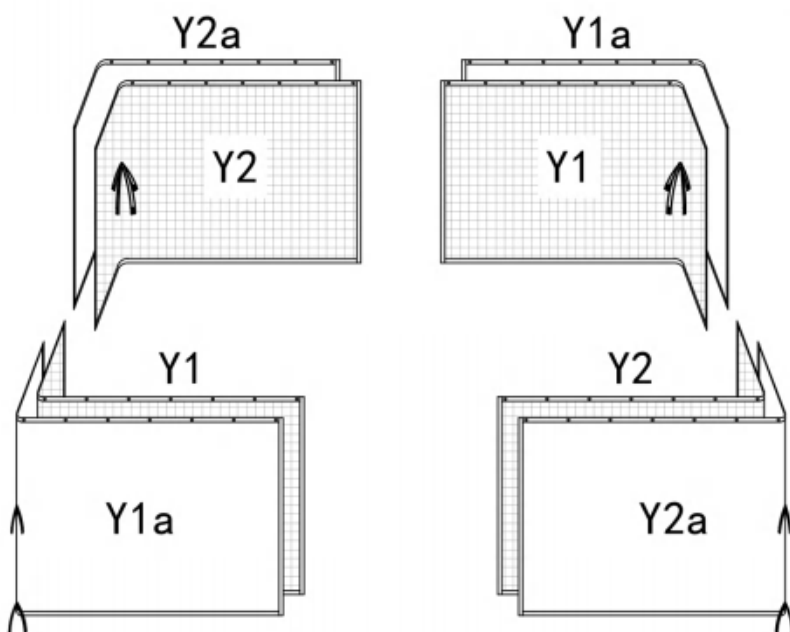
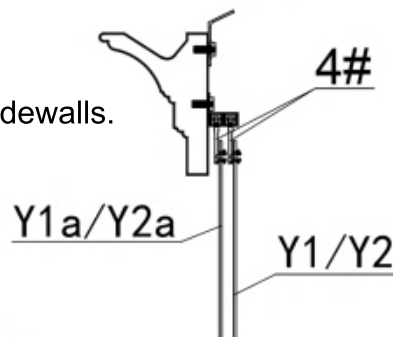

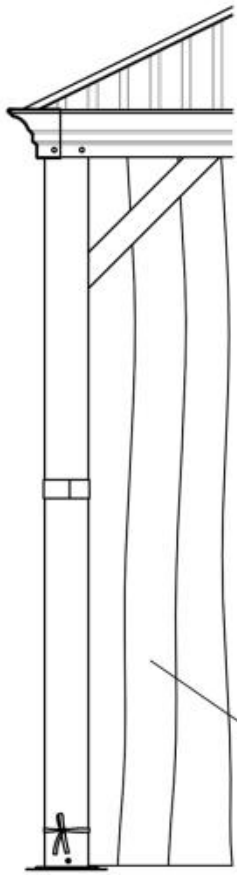

Y1/Y2

Y1a/Y2a

Y1a/Y2a

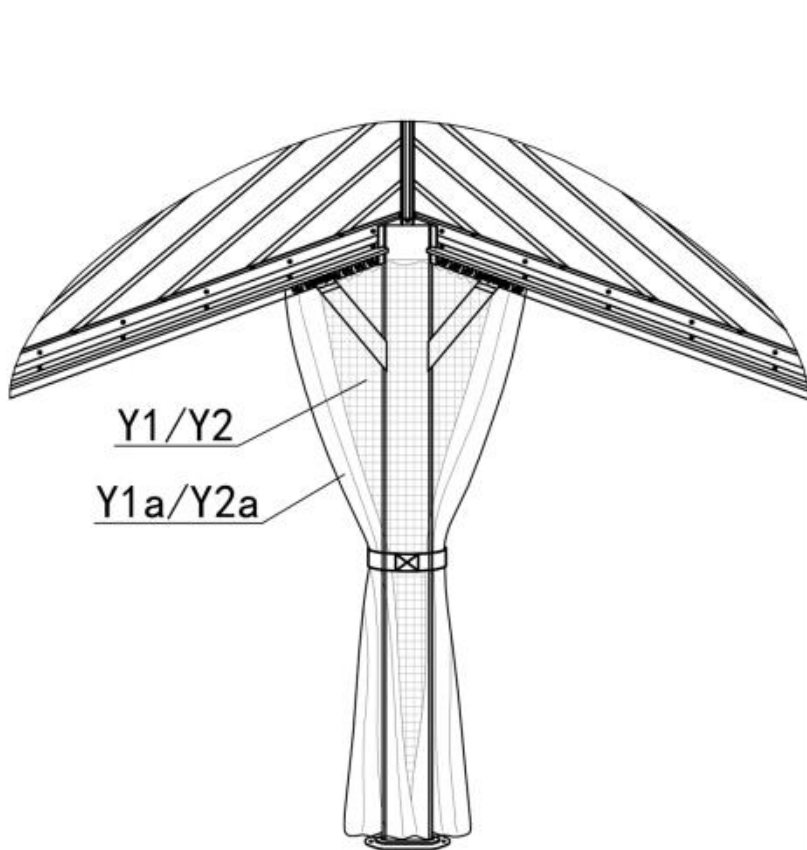
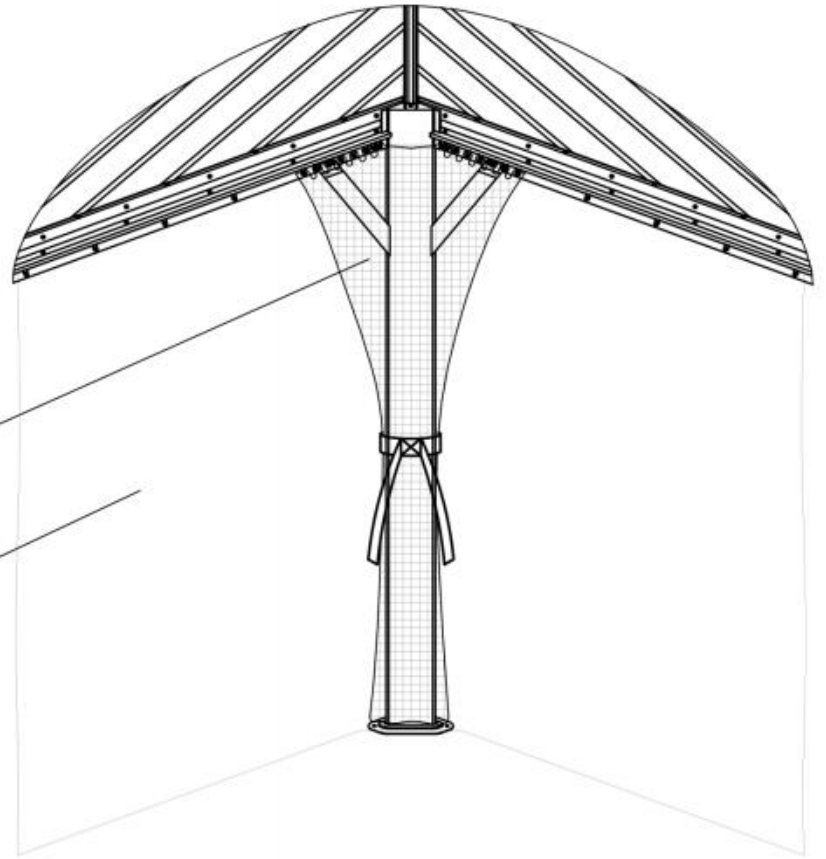

Y1/Y2

Y1a/Y2a

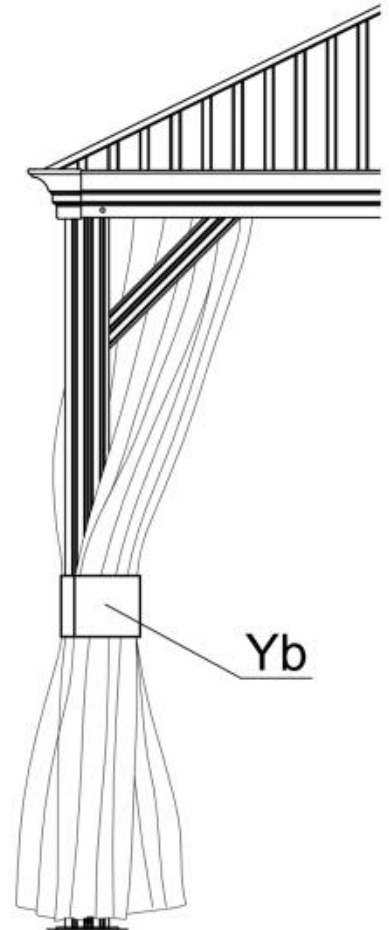

Yb