

READ AND SAVE THIS INSTRUCTIONS FOR FUTURE USE

# ASSEMBLY & INSTRUCTION MANUAL

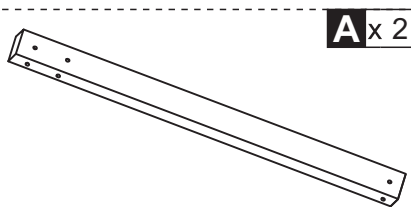

**A** x 2

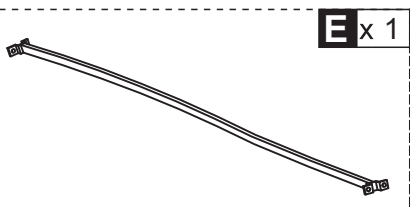

**E** x 1

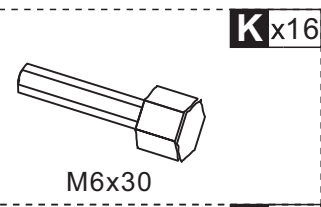

**K** x 16

M6x30

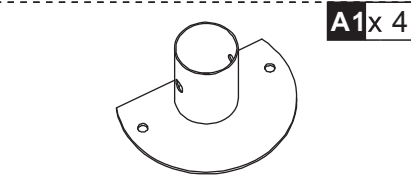

**A1** x 4

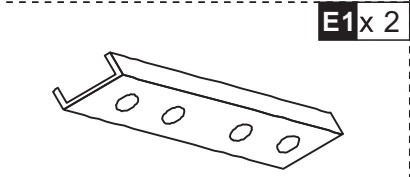

**E1** x 2

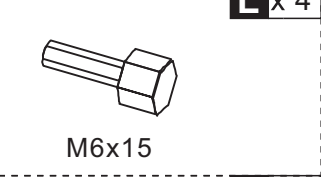

**L** x 4

M6x15

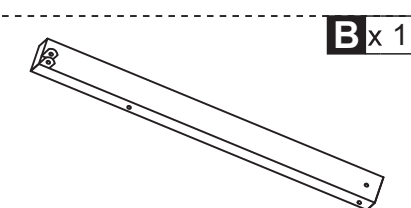

**B** x 1

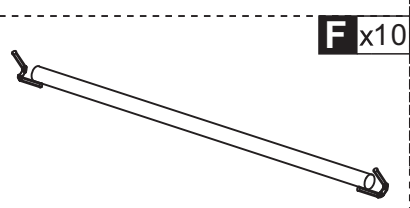

**F** x 10

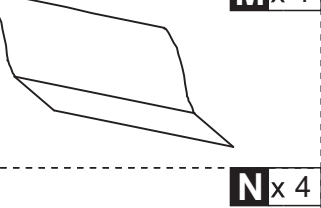

**M** x 1

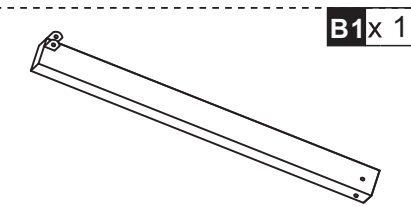

**B1** x 1

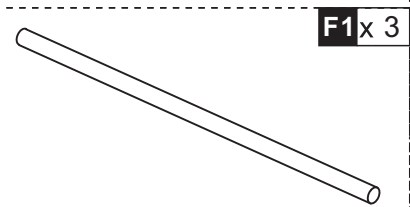

**F1** x 3

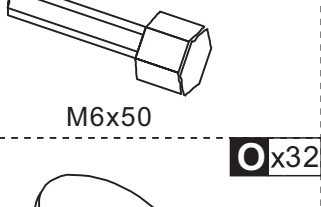

**N** x 4

M6x50

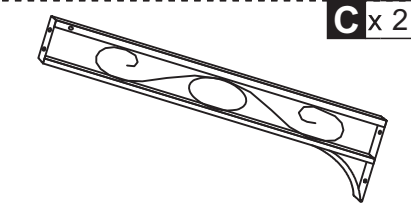

**C** x 2

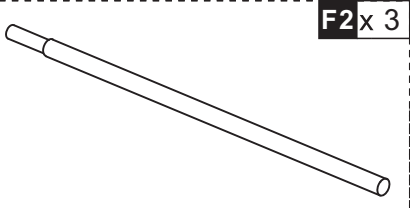

**F2** x 3

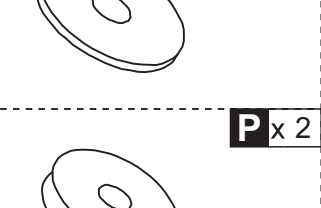

**O** x 32

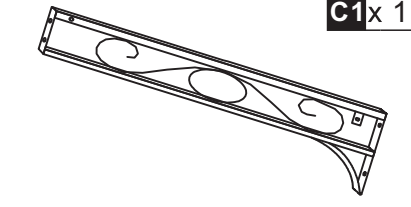

**C1** x 1

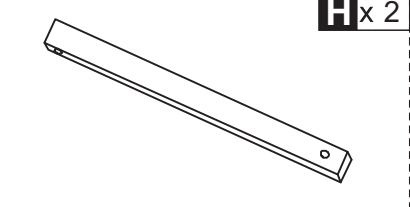

**H** x 2

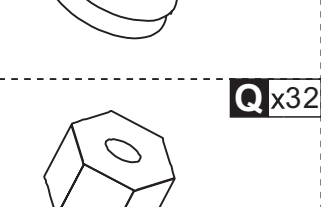

**P** x 2

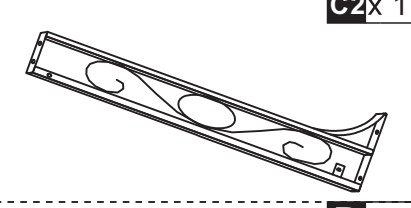

**C2** x 1

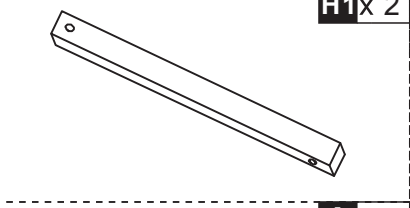

**H1** x 2

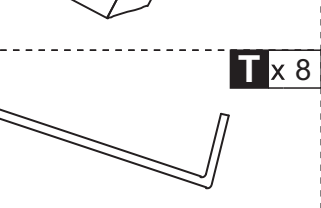

**Q** x 32

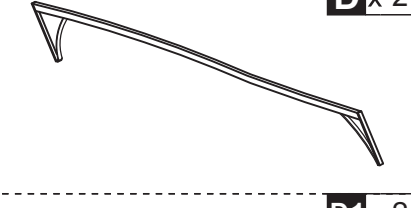

**D** x 2

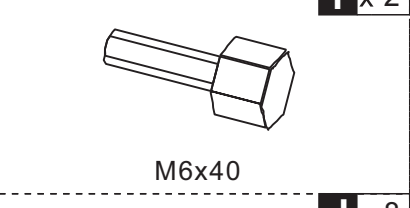

**I** x 2

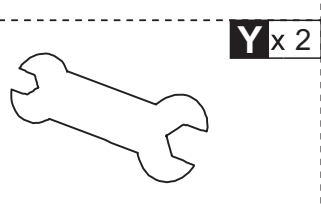

**T** x 8

M6x40

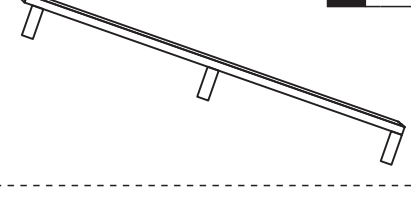

**D1** x 2

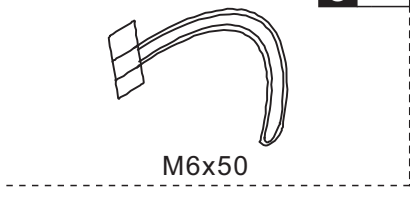

**J** x 8

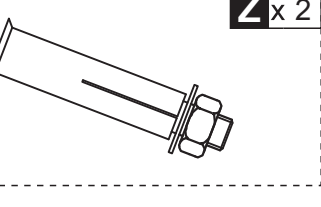

**Y** x 2

M6x50

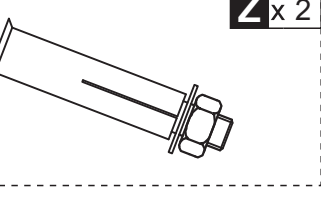

**Z** x 2

C x 2



E1 x 1

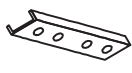

K x 4



M6x30

L x 2



M6x15

O x 6



Q x 6



Y x 2

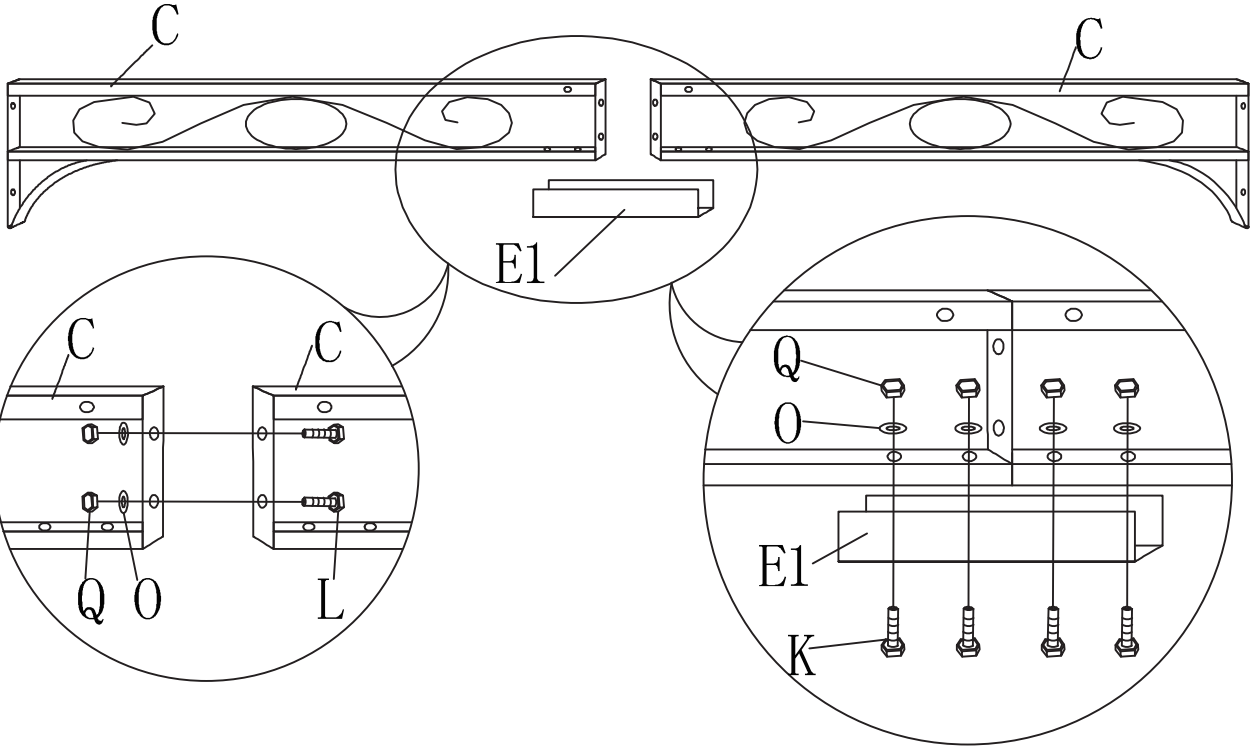

A x 2



A1 x 4



B x 1



B1 x 1



C1 x 1



C2 x 1



D x 2



E x 1



E1 x 1

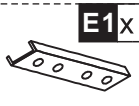

F x 10



J x 8



M6x50

K x 8



M6x30

L x 2



M6x15

N x 4



M6x50

O x 22



Q x 22



T x 8



Y x 2



Z x 2

