

# Assembly Instructions

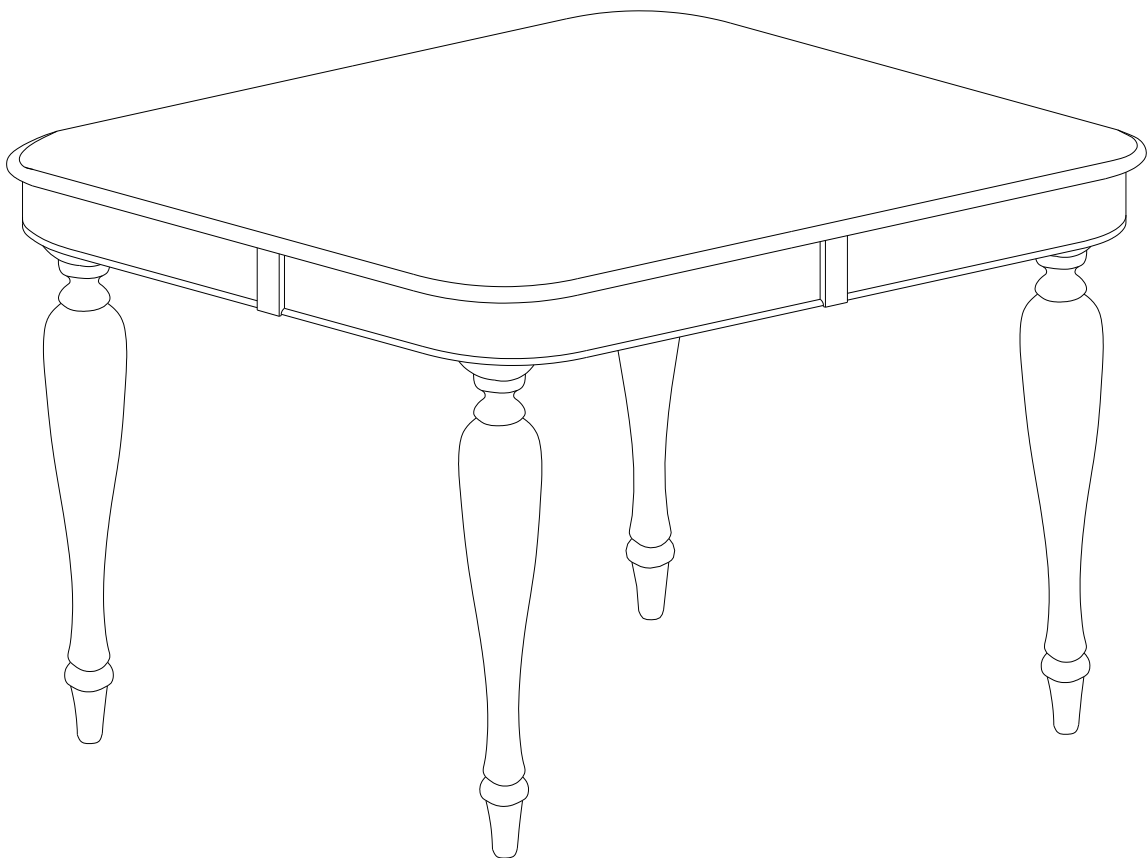

Caution: You must read this before you proceed.

## Table





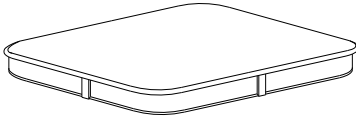

**CAUTION : This Table is NOT a TOY. Keep your child / children at bay during the assembly process. The Table is HEAVY; to prevent injury to yourself or damage to the product a minimum of two adults are required whenever moving or lifting the product.**

## Parts List

Part NO.	Picture	Description	QTY
A		Table Top	1
B		Leg	4

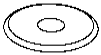
## Hardware

Label	Picture	Description	QTY
①		Bolt (M6*60mm)	8
②		Spring Washer	8
③		Washer	8
④		Allen Key	1

# Assembly Preparation

## Before Beginning Assembly:

Unpack and place all parts for clear visibility

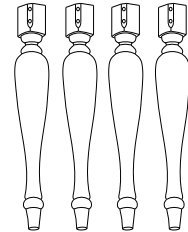
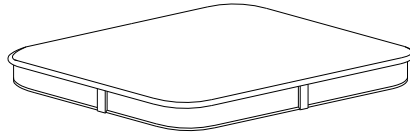

Pack A for assembling the Legs(B) to the Table Top(A)

Bolts  
Spring Washers  
Washers  
Allen Key

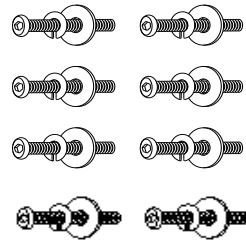

- Read instructions, cover to cover-



- Have 2 adults on hand for assembly-



- Do not assemble on flooring or carpet-



- Assemble on a clean non-marring surface(packaging foam)-



- Save all packaging until finished-

# Assembly Steps

## Overview

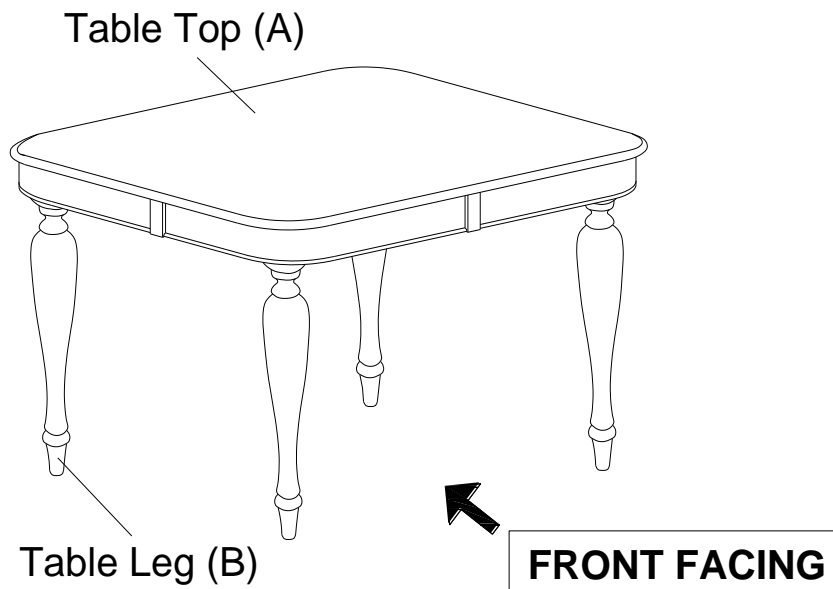

This Table has multiple parts and may require up to 30 minutes to assemble. To give you an overview of the Table parts, the above picture is to help you put the various parts into perspective. Please read through the instructions below to familiarise yourself with the parts and steps before assembly.

## Step 1

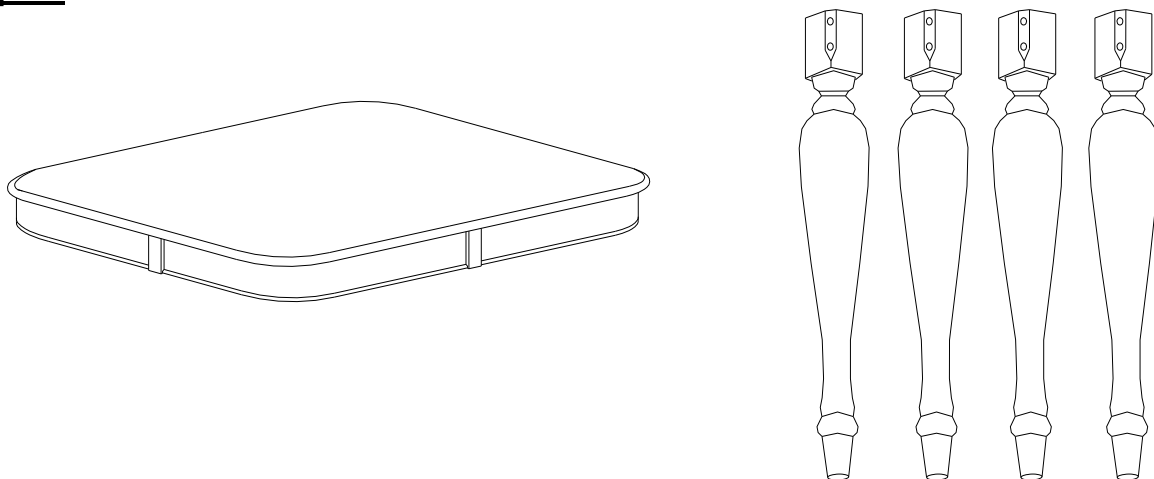

Unpack and place all parts on a clean, non-marring surface.

## Step 2

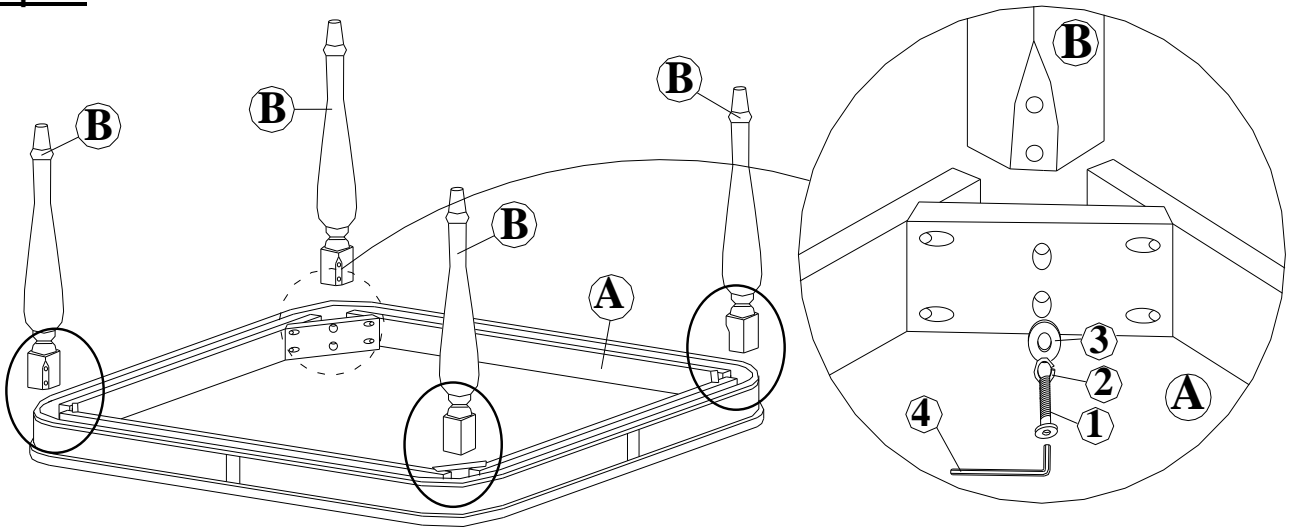

Place the Table Top(A) with its underside skywards onto a clean, non-marring surface to avoid any scratches or damage to the product.  
Insert the Legs(B) into the Mounting Positions at the corners of the TableTop(A).  
Attach Legs(B) to Table Top(A) using Bolts(①), Spring Washers(②), and Washers(③) with Allen Key(④), as shown in the picture above.

**Do not fully tighten the Bolts.**

## Step 3

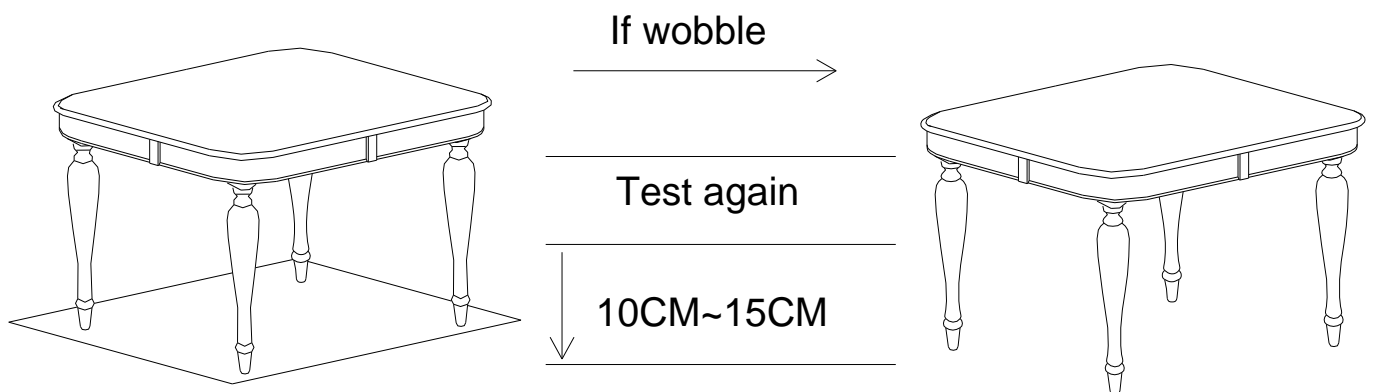

Place the Table on a **LEVEL SURFACE** to check for wobbles.

If it wobbles, with 2 to 3 adult partners, lift the Table some 10cm to 15cm high from the ground.

Keep your feet and toes well away from the drop zone.

Drop the Table freely and vertically with the four legs, hitting the ground, at the same time.

This Drop Test will help to ensure that all the Bolts and gaps to all reach full alignment status.

## Step 4

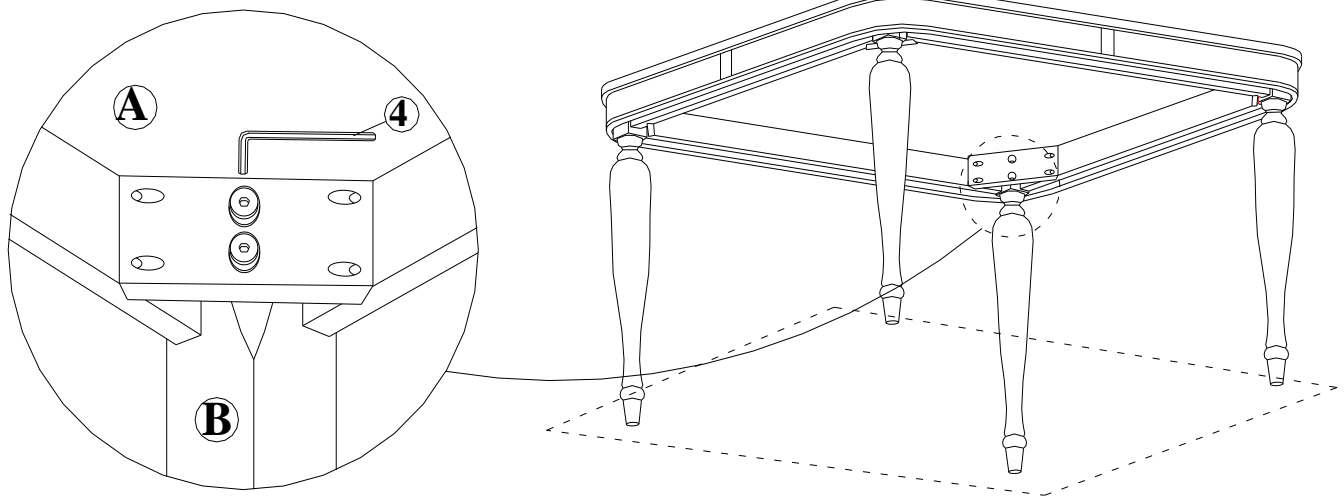

Test again for evenness on a **LEVEL SURFACE**.

If no wobbles found, proceed to tighten all Bolts in a sequential manner with Allen Key.

**When tightening these Bolts, tighten sequentially.**

**DO NOT tighten any Bolt fully and then move on towards the next one.**

**This could cause the frame to warp.**

If there are still wobbles, loosen the Bolts and execute this same drop test.



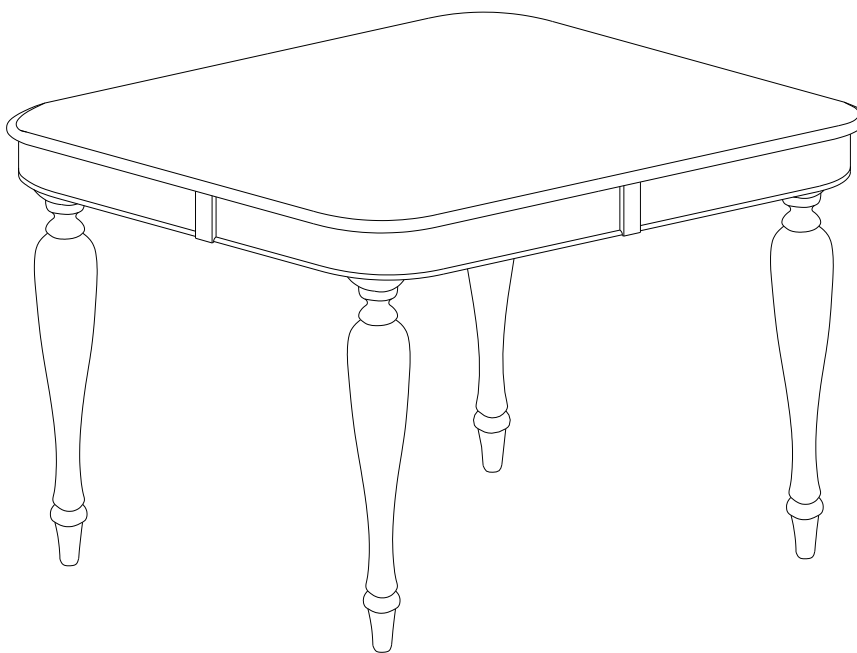

















## Step 5



Your Table is ready for use.

**This Table can only be used on a flat, level surface.**

## Care & Maintenance

-   ● Do not put hot items directly on furniture surface
  -   ● Do not clean furniture with harsh cleansers or polish.
  -   ● Do not place furniture under direct sunlight.
  -   ● Do not place furniture near heating or cooling vents.
  -   ● Do not write on furniture without a padded barrier to protect the surface.
  -   ● Do not place furniture outside . For indoor use only .
  -   ● Not for commercial use. For residential use only .
  -   ● Stains may be removed with mild soap solution and damp cloth.
  -   ● Children should not climb or jump on the furniture.
- 
-   ● Dust and pick-up spills using a clean, non-colored, lint-free cloth .

### What is Proposition 65?

Proposition 65 is a California law that requires warning labels on products that may contain one of more than 800-plus chemicals or ingredients that the California Office of Environmental Health Hazard Assessment (OEHHA) has deemed to cause cancer or other reproductive toxicity. Chemicals and elements on this list include wood dust, brass, and other everyday substances, which can be found in very common household items, such as: lamps, tableware, jewelry, crystal glasses, electric cords, beauty products, automobiles, and furniture.

### Why Did I Find a Proposition 65 Warning on My Home Goods Product?

We include Proposition 65 warnings on all of our products because there is always a chance that one of the 800-plus common chemicals and ingredients listed under this law could potentially be on our furniture or packing materials. We risk large fines under this law, if we don't include this warning.

### Should I worry?

We realize you may be worried finding this warning on our products, but we want to reassure you that the hazardous exposure limits for any of these chemicals have never been found on furniture products that we've shipped to our customers. Additionally, this warning label is very common and can be found on almost every piece of furniture sold in the state of California.

### Just How Common Are Proposition 65 Warnings?

Proposition 65 warnings have become so common in California that it is hard to take a trip to a local bank, grocery store, or restaurant without finding at least one warning. In fact, even the Disney Land Resort has a Proposition 65 warning:

