







Assembly Sheet

BREAKFAST STOOL

NO.	Illustration	Description	QTY/QTE	NO.	Illustration	Description	QTY/QTE
A		shelf	1	B		legs	2
C		cross brace	2	D		cross brace (with holes)	2
E		screw M6*12	16	F		scrw M6*40	4
G		aleen key4*4	1				

① insert the cross brace (C&D) to the legs (B) with screw E

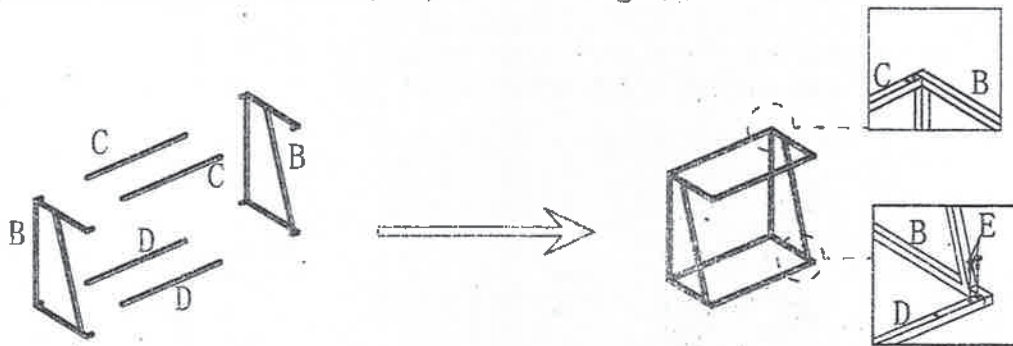



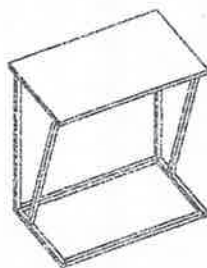
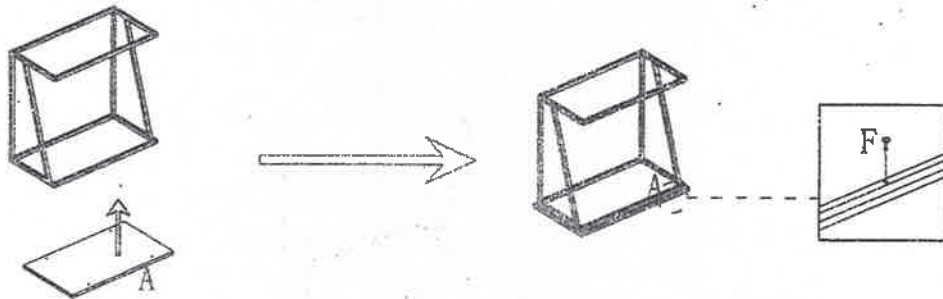





② Attach the shelf to the metal body and tighten with scrw F



Assembly Sheet

BREAKFAST TABLE

NO.	Illustration	Description	QTY/QTE	NO.	Illustration	Description	QTY/QTE
A		shelf	1	B		legs	2
C		cross brace	1	D		cross brace (with hole)	2
E		screw M6*12	12	F		screw M6*40	4
G		allen key 4*4	1	H		25*25 plastic caps	4

① insert the cross brace (C&D) to the legs (B) with screw E, and plug with the plastic caps H

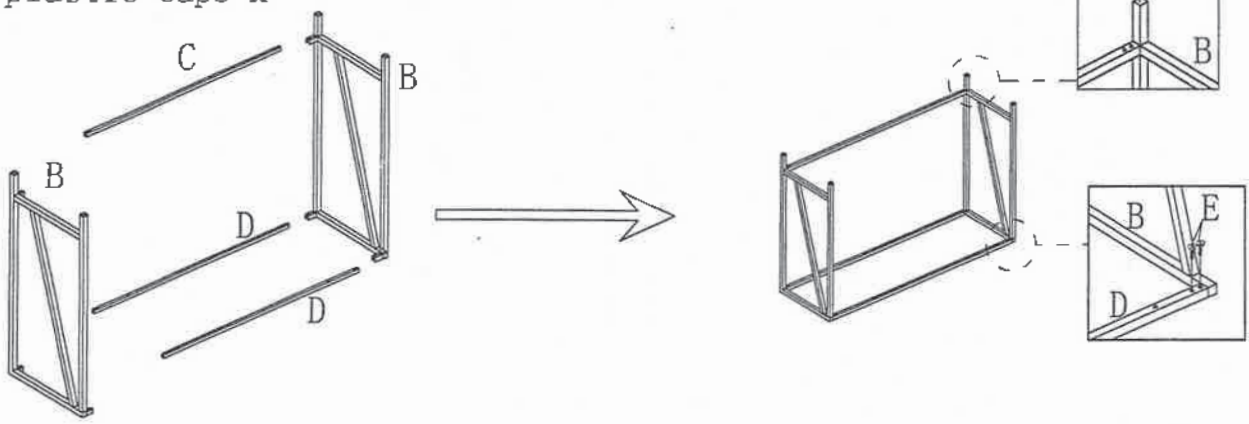

② Attach the shelf to the metal body and tighten with screw F

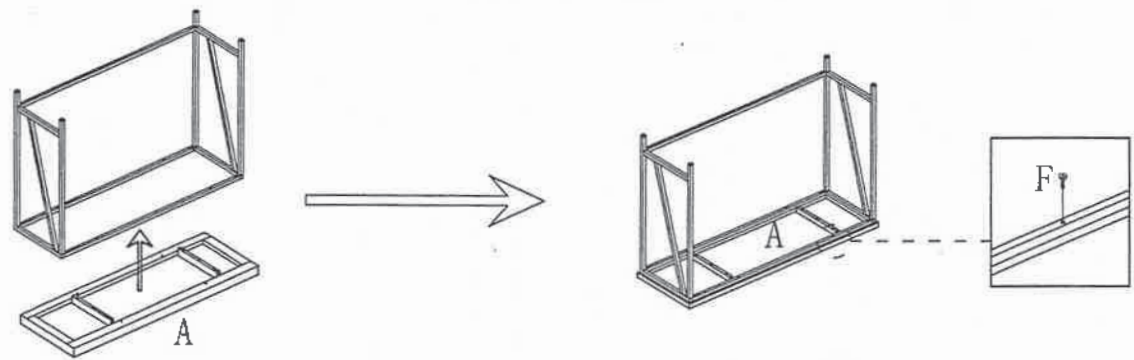

Feuille D'assemblage

TABOURET DE PETIT DÉJEUNER

NO.	Illustration	Description	QTY/QTE	NO.	Illustration	Description	QTY/QTE
A		Étagère	1	B		jambes	2
C		cross brace	1	D		Croisillon (avec trous)	2
E		Vis M6*12	12	F		Vis M6*40	4
G		Aleen clé 4*4	1	H		25 * 25 bouchons en plastique	4

- ① Insérer la traverse (C & D) sur les pieds (B) avec la vis E, et la fiche avec les bouchons en plastique H

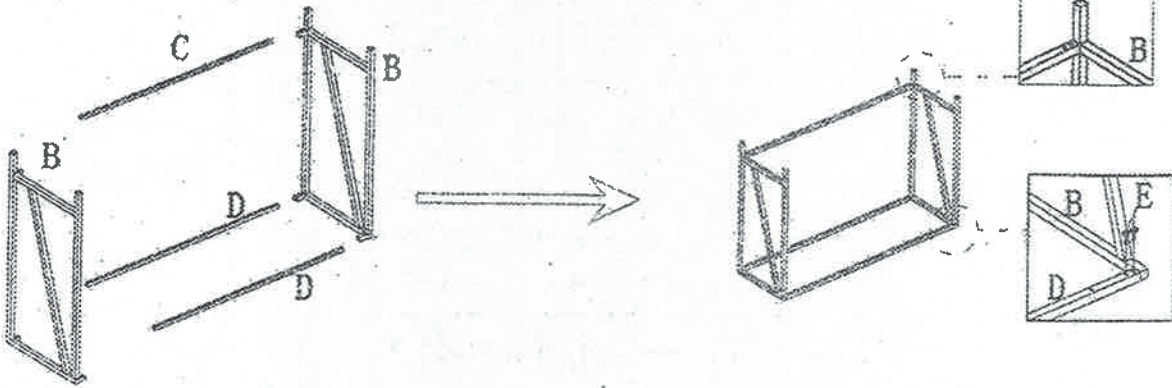



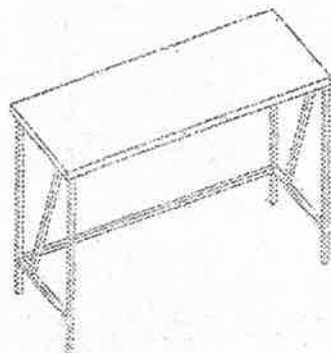
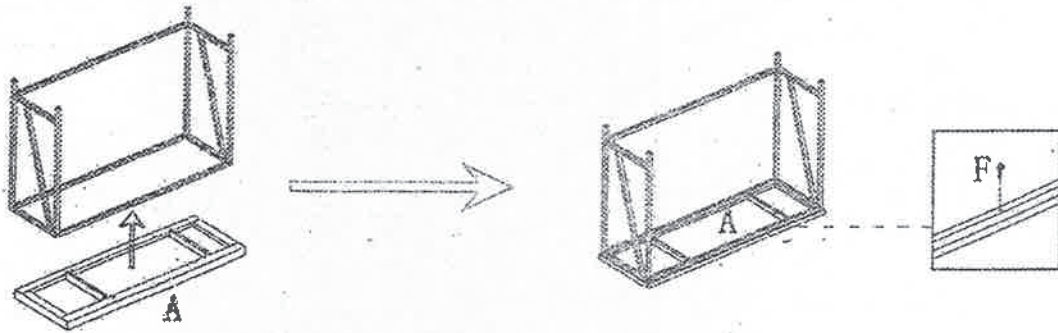



- ② Fixer le plateau sur le corps métallique et serrer avec la vis F



Feuille D'assemblage

TABOURET DE PETIT DÉJEUNER

NO.	Illustration	Description	QTY/QTE	NO.	Illustration	Description	QTY/QTE
A		Étagère	1	B		jambe	2
C		cross brace	2	D			2
E		Vis M6*12	16	F		Vis M6*40	4
G		clé Allen 4*4	1				

① Insérer la traverse (C&D) sur les pieds (B) avec la vis E

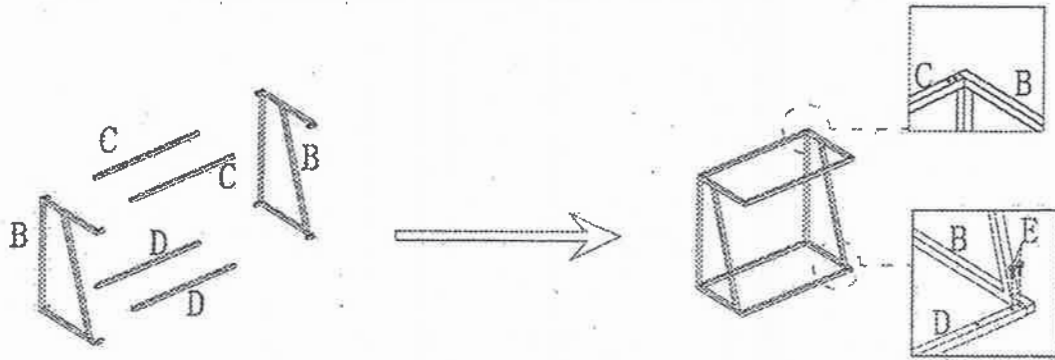

② Fixer le plateau sur le corps métallique et serrer avec la vis F

