

INSTRUCTION

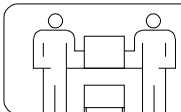
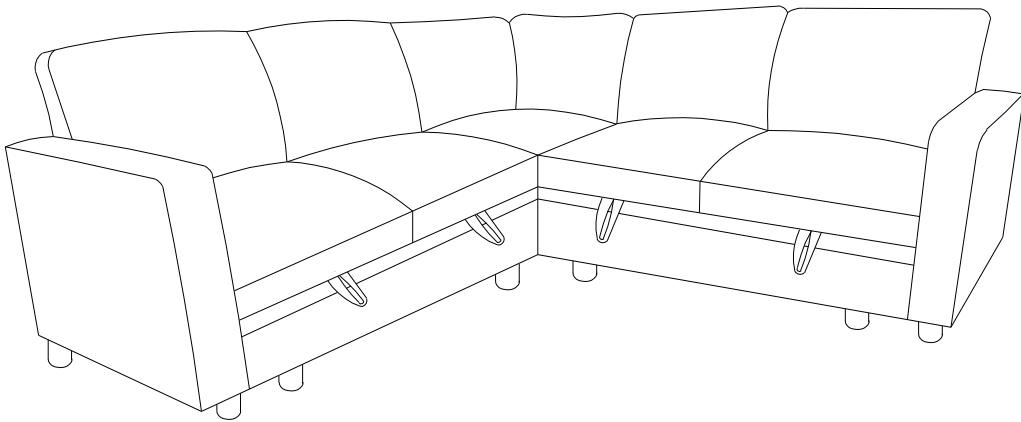

TEAM
ASSEMBLY
RECOMMENDED

SOFA

PARTS LIST

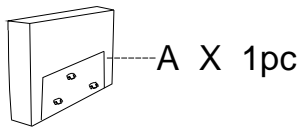

A X 1pc

Left arm

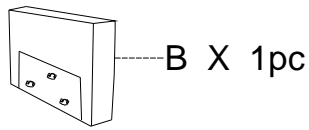

B X 1pc

Right arm

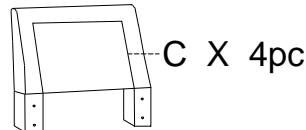

C X 4pc

Backrest

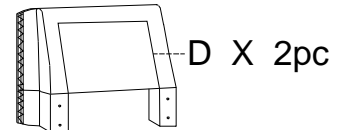

D X 2pc

Corner Backrest

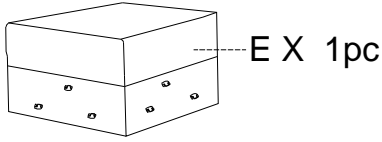

E X 1pc

Corner couch

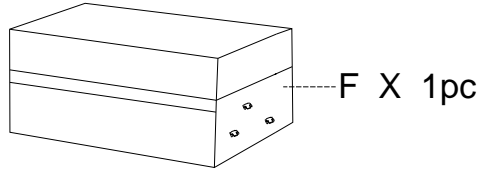

F X 1pc

Pull out Couch

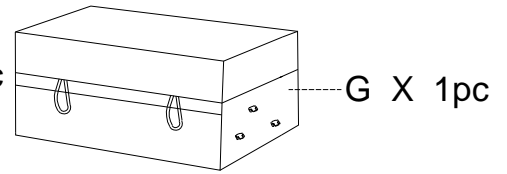

G X 1pc

Storage couch

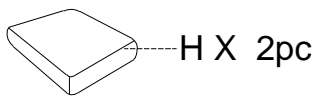

H X 2pc

Storage cushion

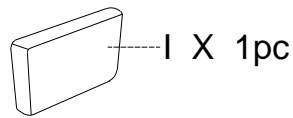

I X 1pc

Corner cushion

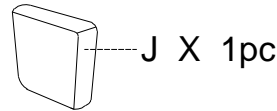

J X 1pc

Corner cushion

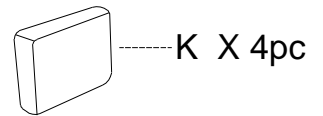

K X 4pc

Back cushion

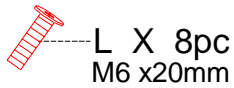

L X 8pc
M6 x20mm

Short screw

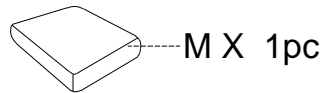

M X 1pc

corner seat cushion

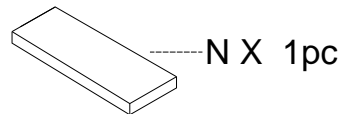

N X 1pc

Pull out bed cushion

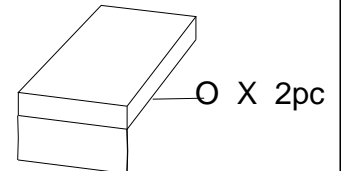

O X 2pc

Couch-F cushion

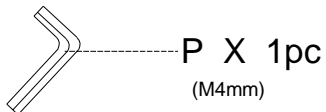

P X 1pc
(M4mm)

L-Shaped Wrench

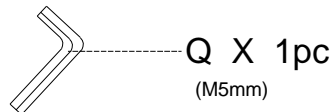

Q X 1pc
(M5mm)

L-Shaped Wrench

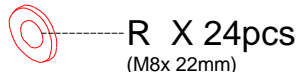

R X 24pcs
(M8x 22mm)

Washers

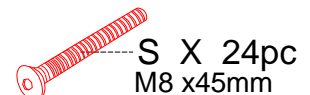

S X 24pc
M8 x45mm

Short screw

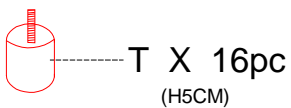

T X 16pc
(H5CM)

Legs

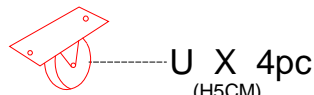

U X 4pc
(H5CM)

Wheels

STEP 1 Ship by 3 boxes

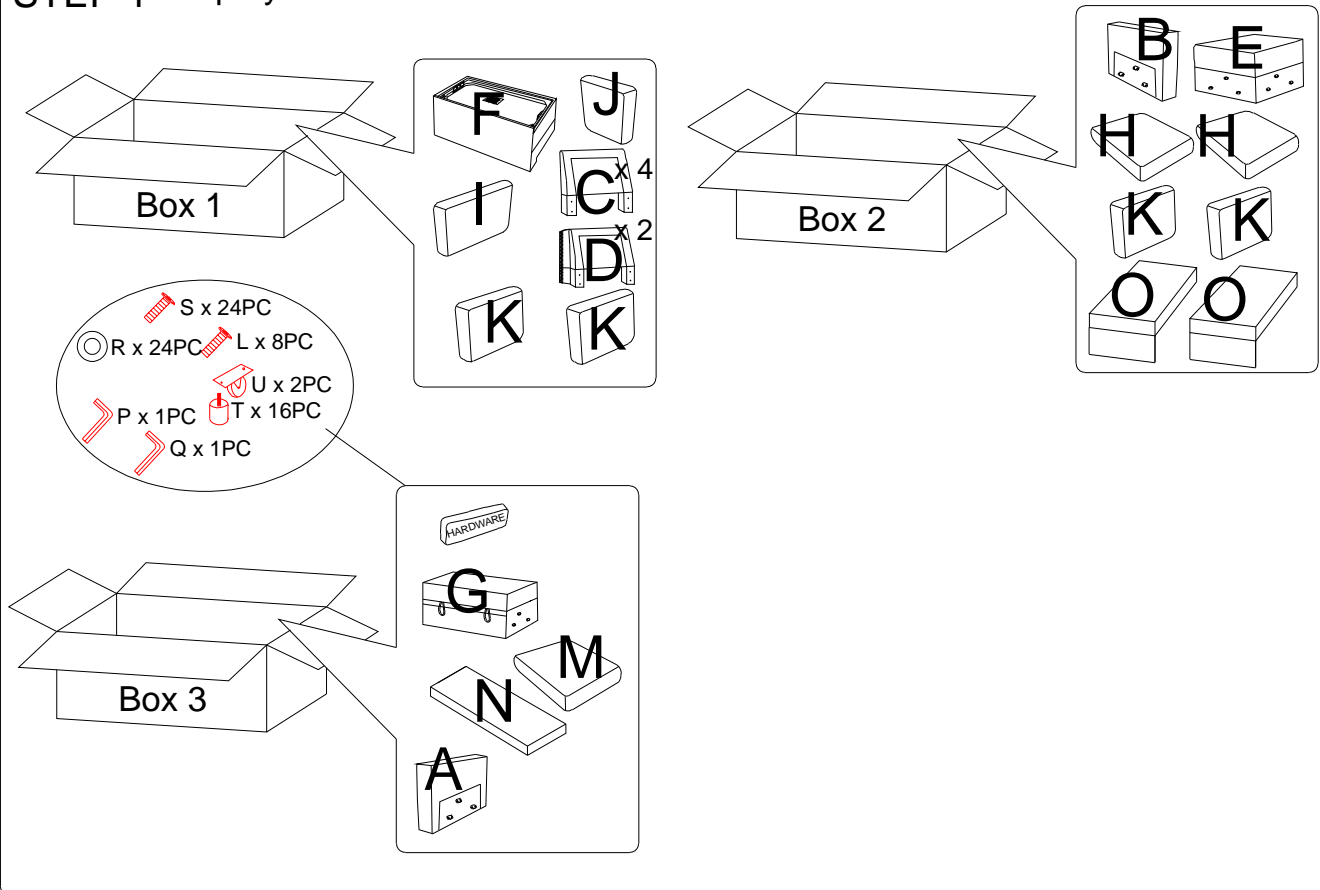

STEP 2

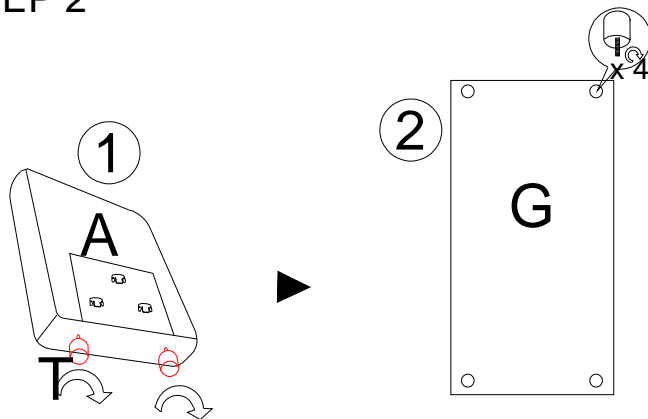

NO	DESCRIPTION	pcs
T		6
R		8
S		8
Q		1

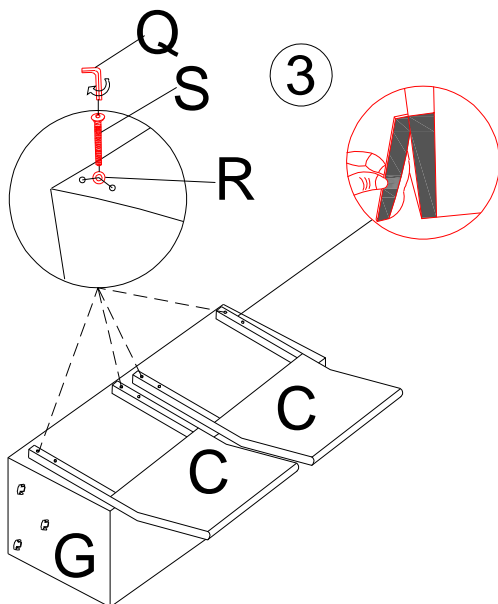

After locking the screws, the backing cloth needs to be attached to the Velcro.

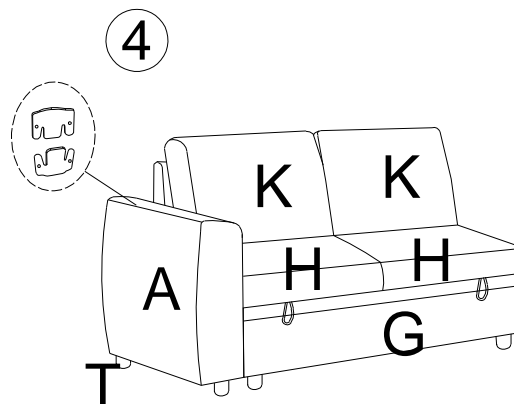

STEP 3

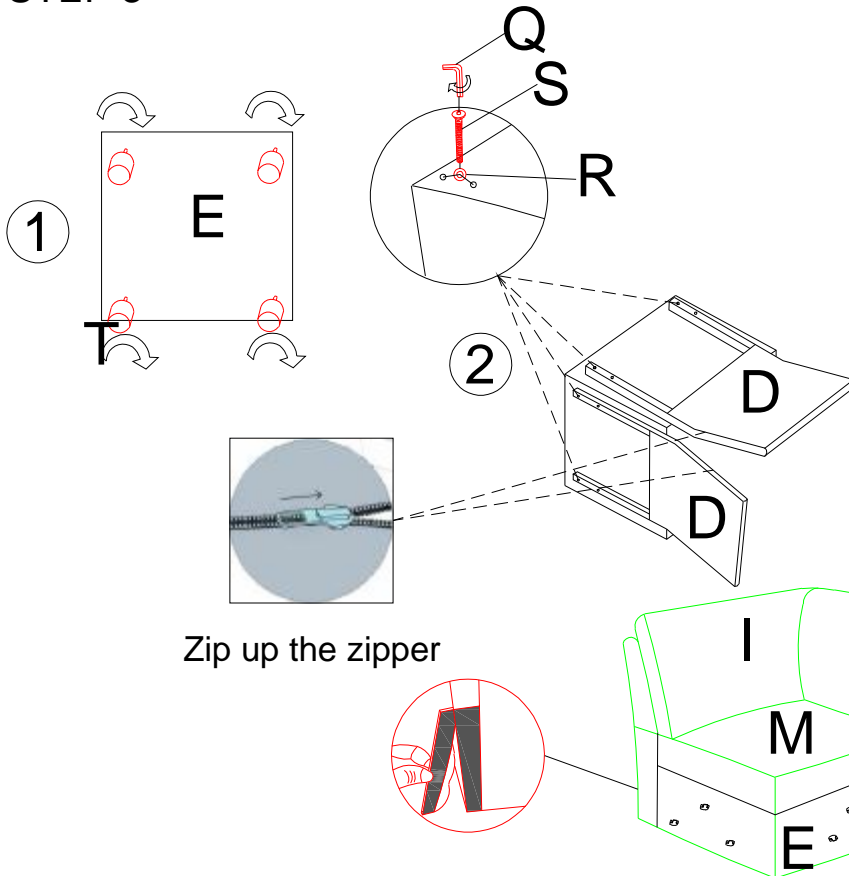

Zip up the zipper

NO	DESCRIPTION	pcs
T		4
R		8
S		8
Q		1

After locking the screws, the backing cloth needs to be attached to the Velcro.

STEP 4

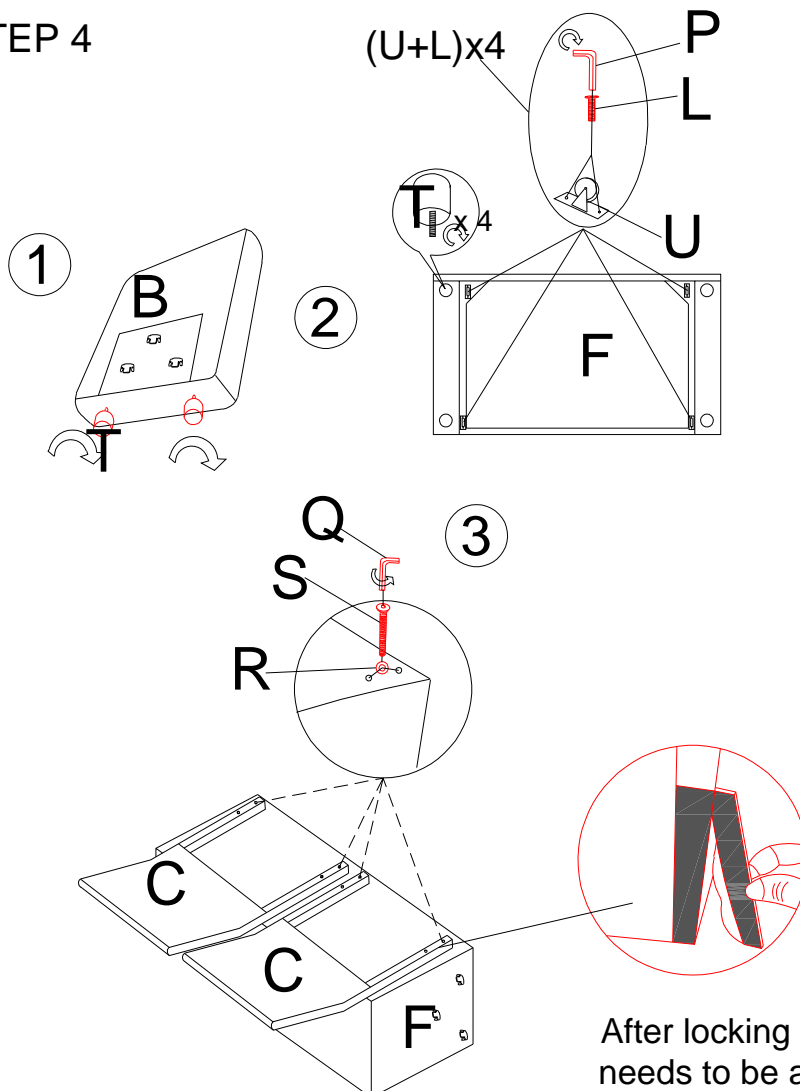

NO	DESCRIPTION	pcs
T		6
U		4
R		8
S		8
Q		1
L		8
P		1

After locking the screws, the backing cloth needs to be attached to the Velcro.

STEP 5

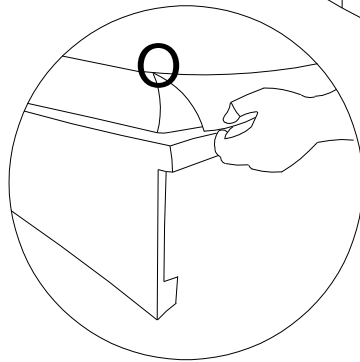
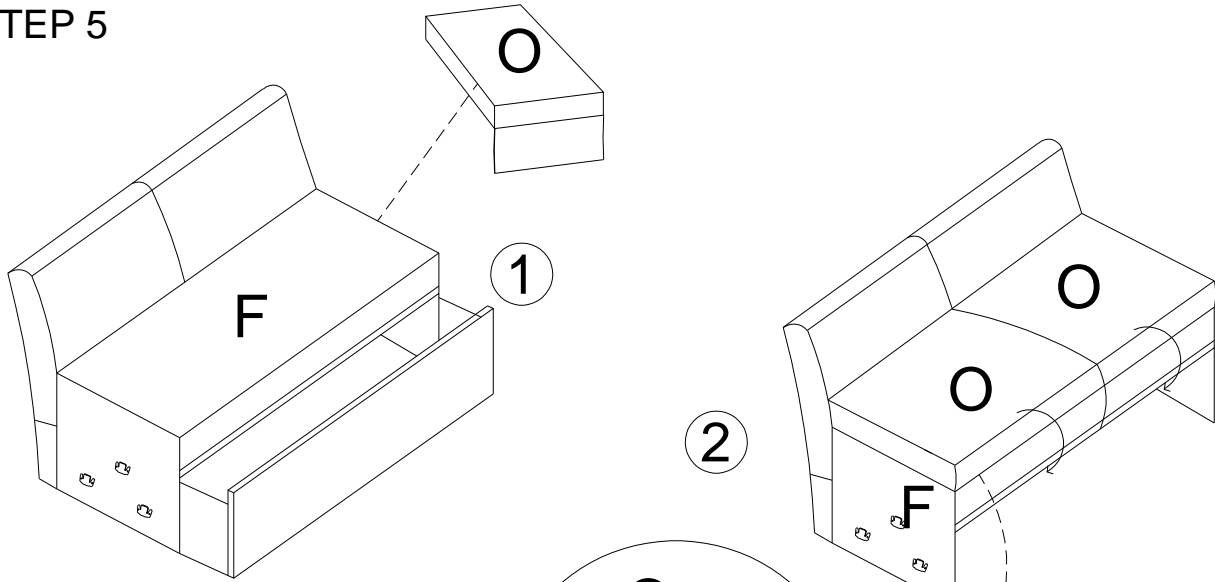

Put the Cushion-O on the sofa, backing cloth needs to be attached to the Velcro.

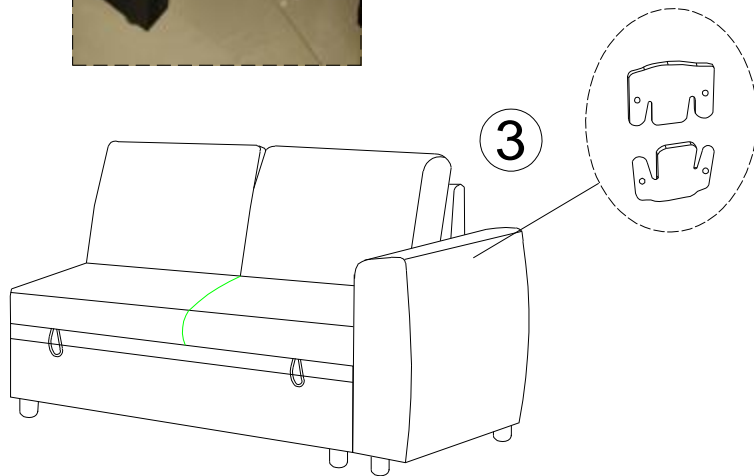

STEP 6

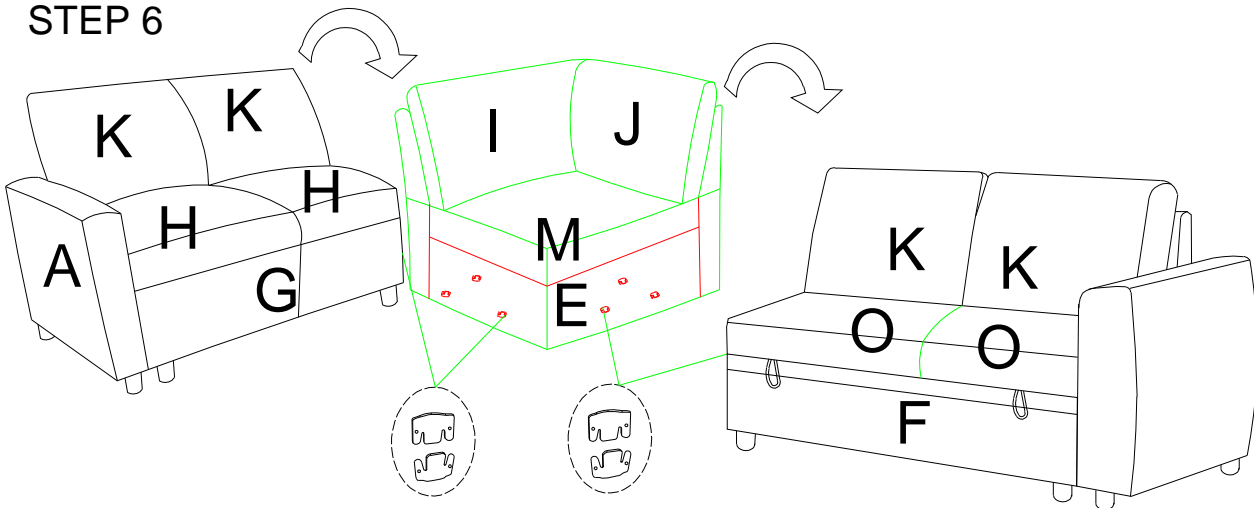

STEP 7

Pull out couch(F) and storage couch(G) can be interchangeable

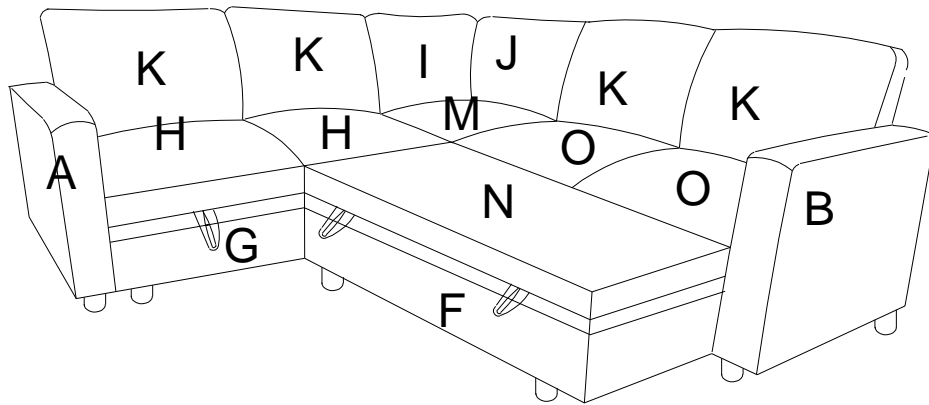

STEP 8

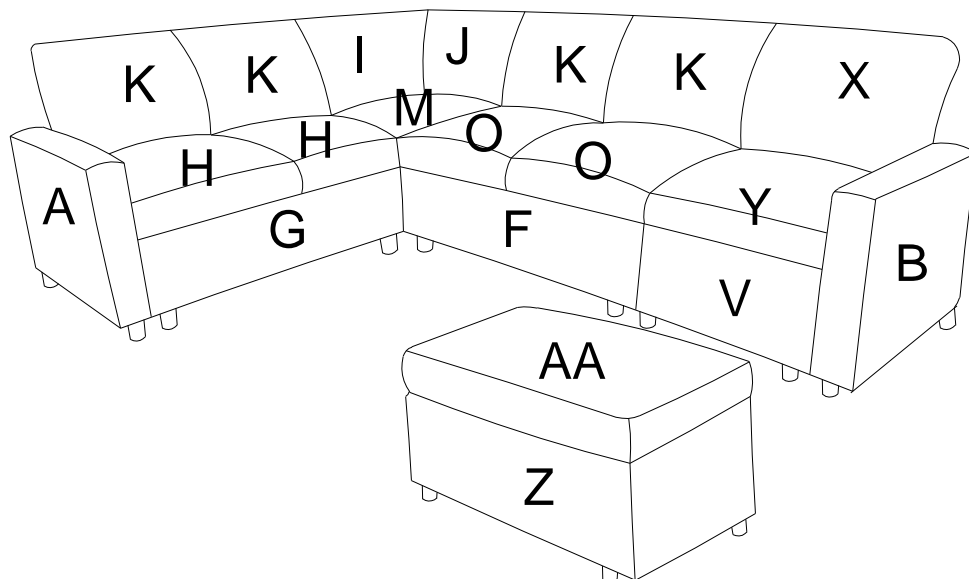

Notice:

Thank you for purchasing this quality product. Be sure to check all the packing material carefully for small parts, which may have come loose inside the carton during shipment. Identify and count all parts and compare with Part List on Page 1. This sofa is covered by 1-year Limited Warranty for Manufacturing Defects. Please read this Warranty Information carefully for your benefit. This warranty is for manufacturing defects.

Warranty Information

This warranty is for manufacturing defects only and does NOT cover normal wear & tear or damages resulting from misuse.

Warranty Details.

1. Your sofa's 1-year Limited Warranty for Manufacturing Defects starts on the date of purchase. No warranty will be honored without an original sales receipt. The warranty and financial responsibility of the manufacturer applies only to the products themselves.
2. Manufacturing defects may include circumstances where the product is broken under normal use and hence cannot provide proper support. In the event of a manufacturing defect found in your sofa, please stop using it immediately and contact the authorized seller.
3. This warranty applies only if the product has been used properly by consumers who purchase it from authorized sellers as a new product. Proper use is defined by but not limited to level surface where all legs touch the floor with an equal distribution of weight and no out-of-the-ordinary abuse by the consumer. This warranty does not constitute agreement to replace other parts.
4. If this sofa fails to perform as advertised due to manufacturing defects, the manufacturer will repair or replace at its discretion reserves the right to substitute comparable materials or models and does not guarantee that the replacement part will match existing pieces.
5. In the event the product needs to be inspected by the manufacturer to determine a warranty claim, transportation and removal cost will be borne by the consumer.