

# Components

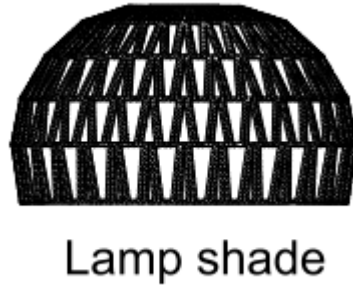

US&CA

EU&UK

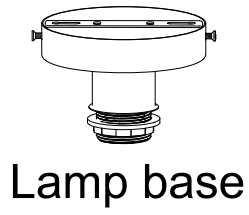

X2

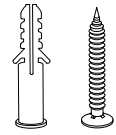

X2



X3

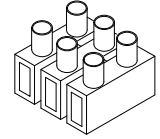

X1

## Step 1

US&CA

EU&UK



X3

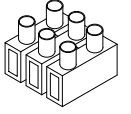

X1

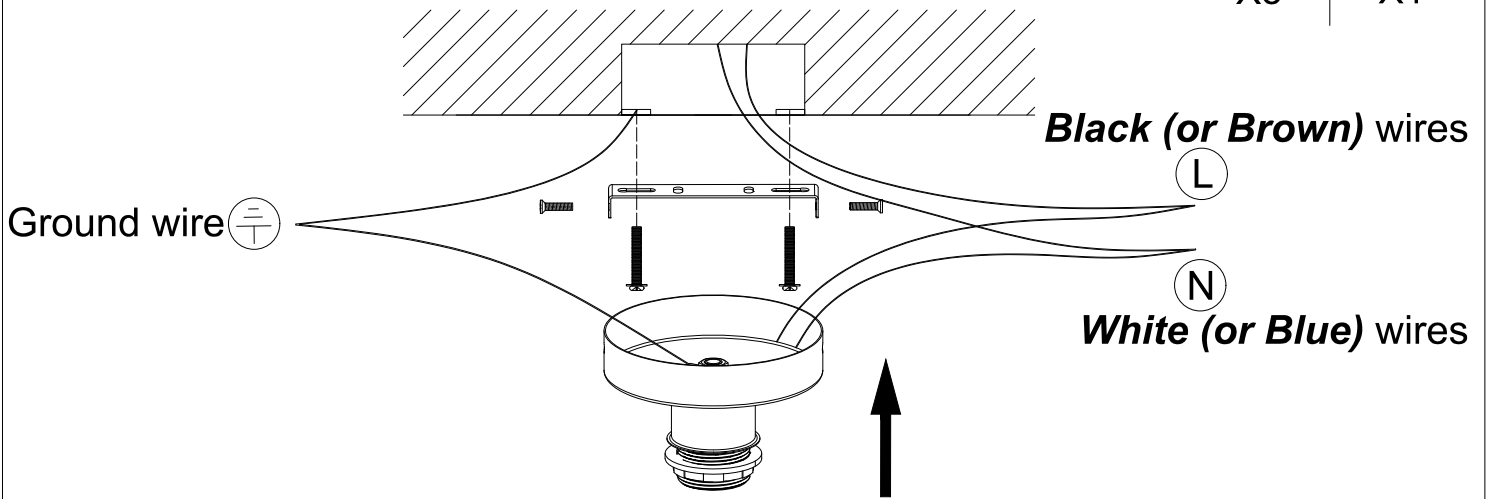

## Step 2

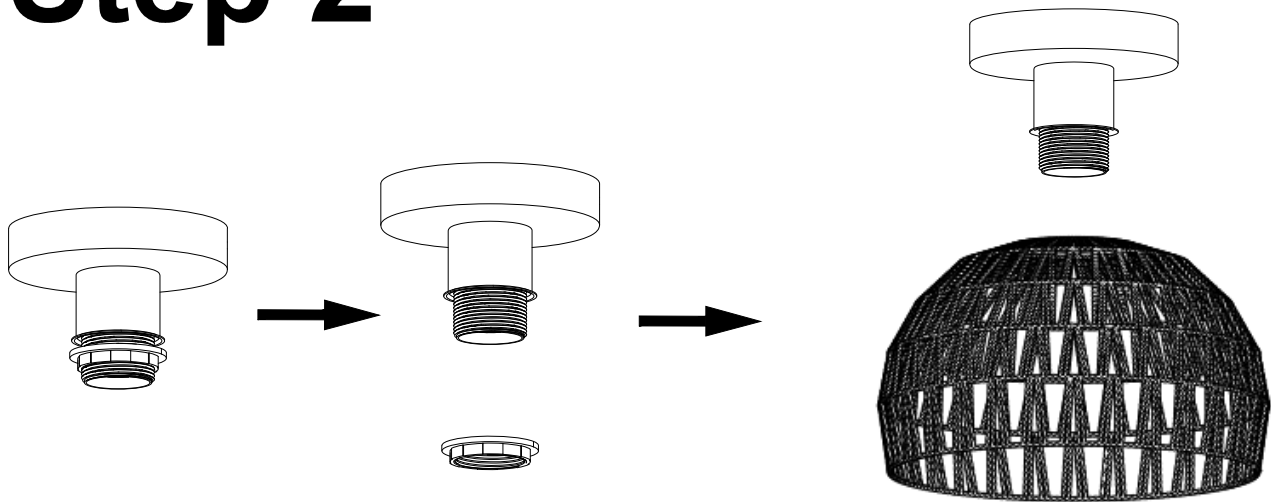

(Bulbs Not Included)