

INSTALLATION

CAUTION

Parts are placed at the bottom of the product.







Assembly Instructions

CAUTION

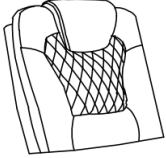
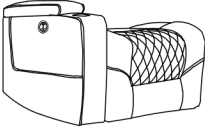
DO NOT use any sharp objects to open plastic wrapped components as this may result damage to product or components .

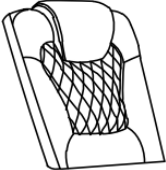
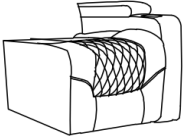
This product comes in four kinds of packages. Carefully remove all of components from the packaging and set aside for assembly.

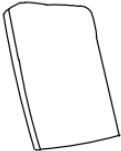
Package Contents

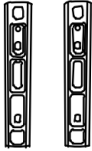
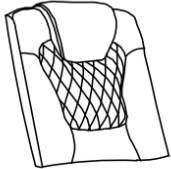
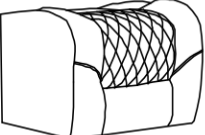
BOX 1				
	A*1	B*1	C*1	D*1
BOX 2				
	E*1	F*1	C*1	D*1
BOX 3				
	G*1	H*1	I*1	
BOX 4				
	J*1	K*1		

1 RECLINER ASSEMBLY - BODY SETUP

STEP1:

Remove **Back(G)** from the bottom of the **Console(H)** and take the parts out of the small compartment at the bottom of the **Seat**.

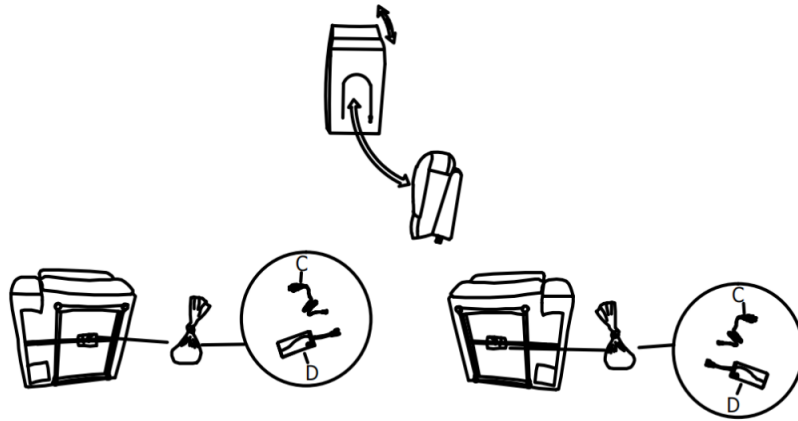

STEP2:

Assemble the **Back (A&G&E&J)** to its **Seat (B&K&F)** and **Console (H)** by metal sliders, making sure it is securely installed before use. Next attach **Seat(B&K&F)** and **Console (H)** by metal grooves on seat to seat as shown.

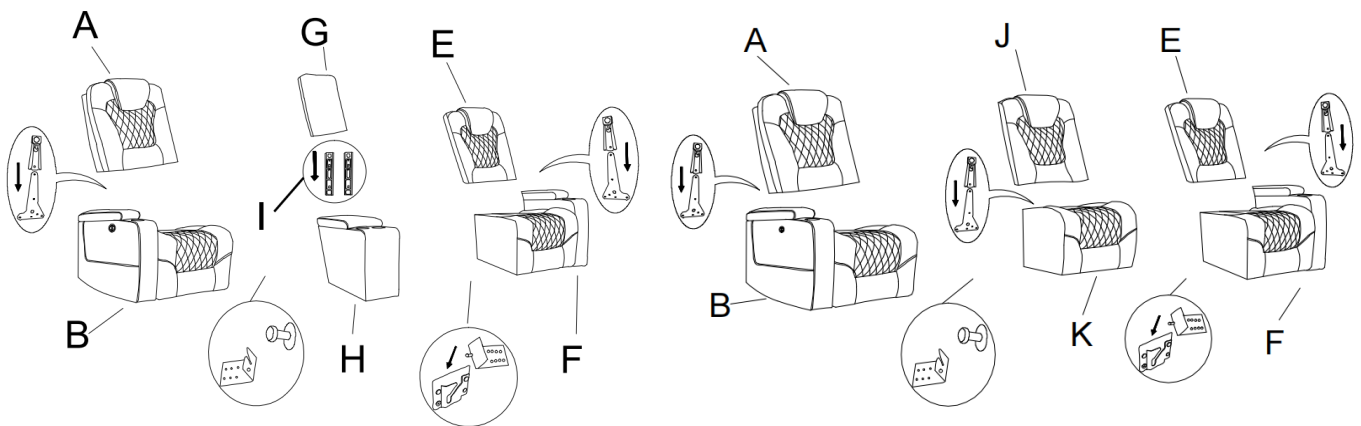

2 RECLINER ASSEMBLY - WIRES CONNECT

STEP3:

Connect the **Converter (D)** and **Power Cord(C)** to your seat, finally the power line that has been installed to power on.

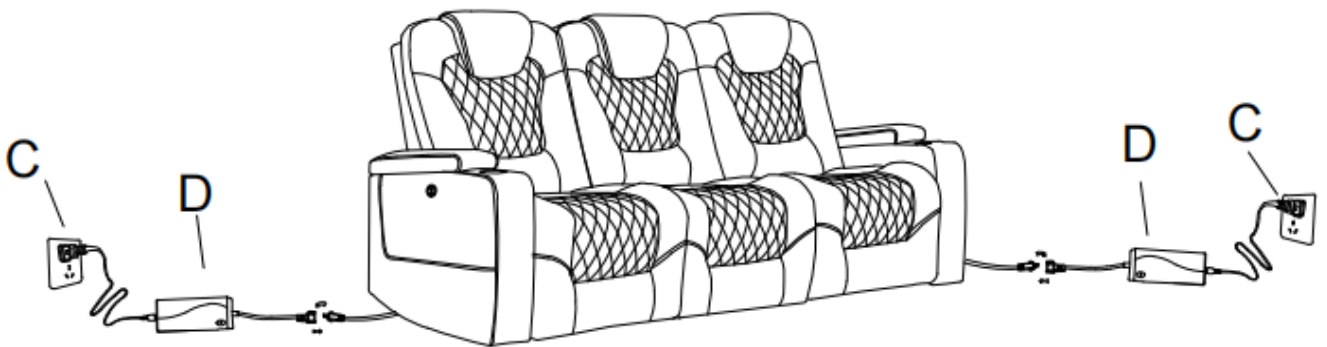
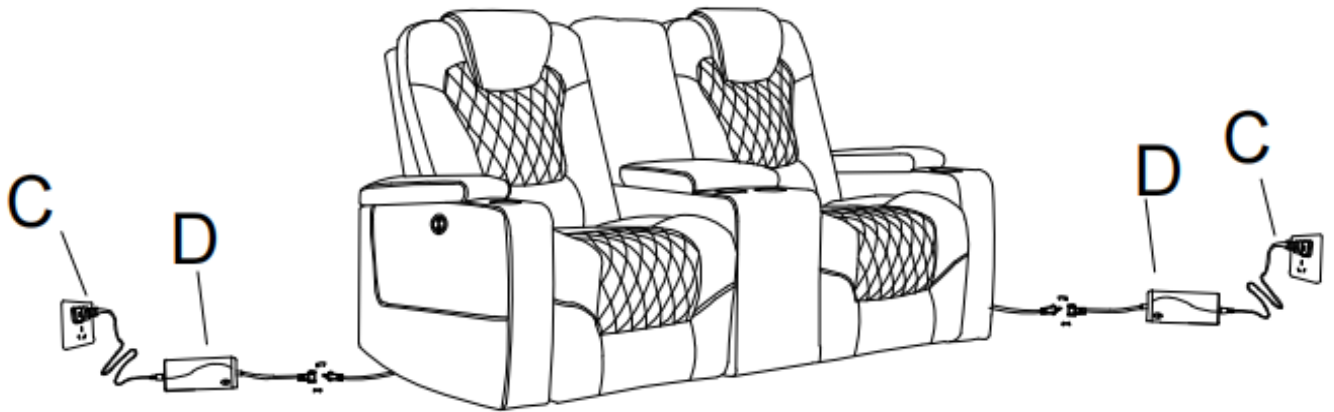

3 INSTRUCTIONS FOR USE - SIZE DIMENSIONS

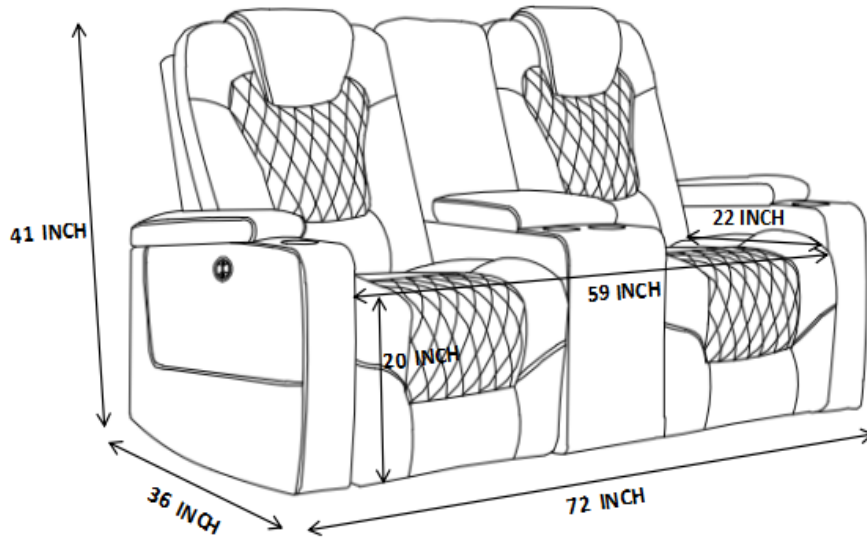

Loveseat

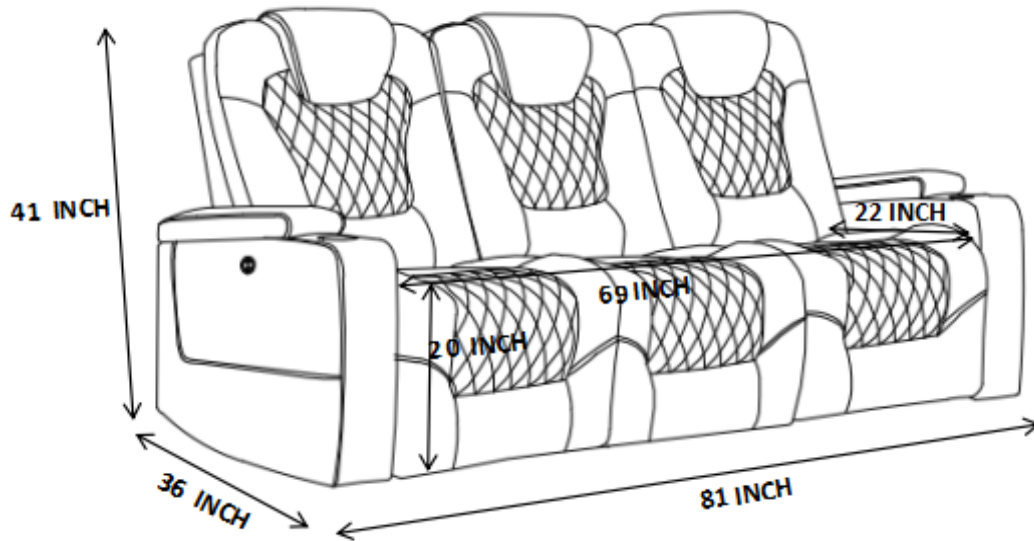

Sofa

⚠️ WARNINGS

1. Please check if the components of the chair are all included and can be used normally.
2. Assemble all components according to the instruction correctly before you connect the chair to the power.
3. Please DO NOT sit on the armrests or footrest to eliminate the risk of tipping over.
4. If the chair is damaged or doesn't match the website description, please send clear pictures of the product and label of the carton to our service team for further help.
5. If the recliner doesn't work, you may try the following measures for self-checking firstly:
 - a) check if all the cables are connected;
 - b) check if the light of transformer is on.

If the chair still doesn't work, please feed the information back to our customer service in time and we will help you solve the matter as soon as possible.

