

ASSEMBLY INSTRUCTIONS

TEAKWOOD TROLLEY BAR (ATF65)

STEP 1

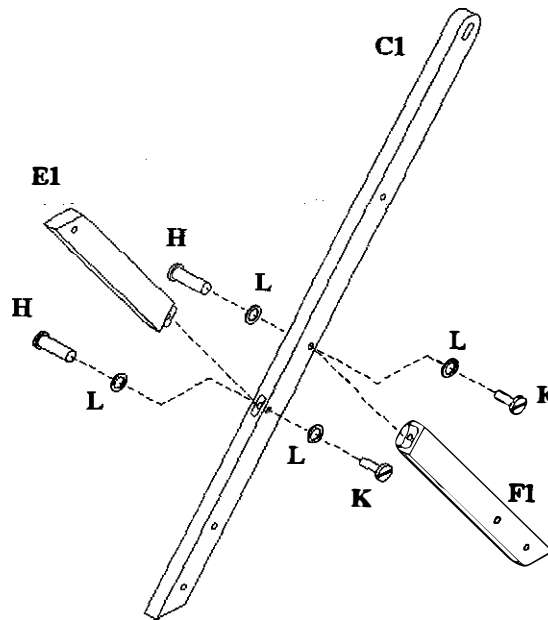

STEP 2

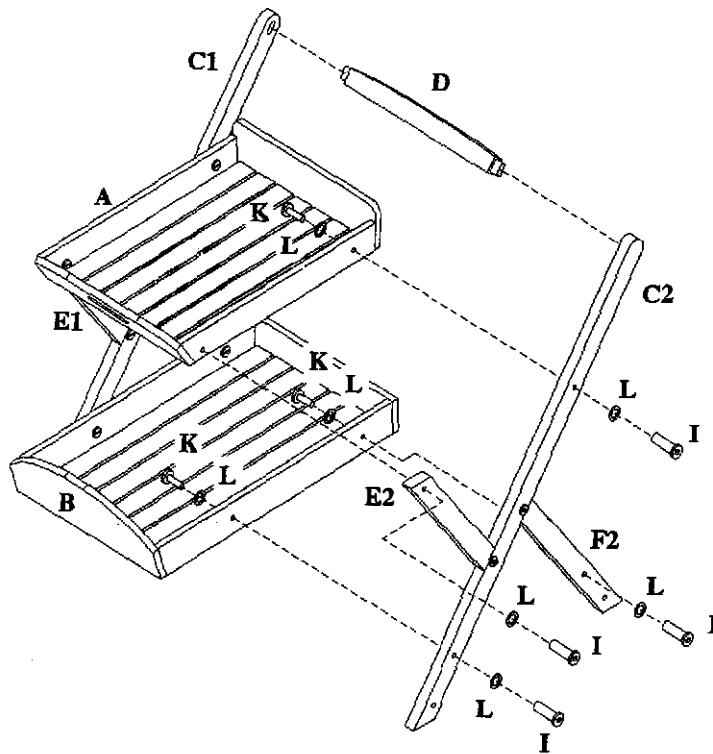

ASSEMBLY INSTRUCTIONS
TEAKWOOD TROLLEY BAR (ATF65)

STEP 3

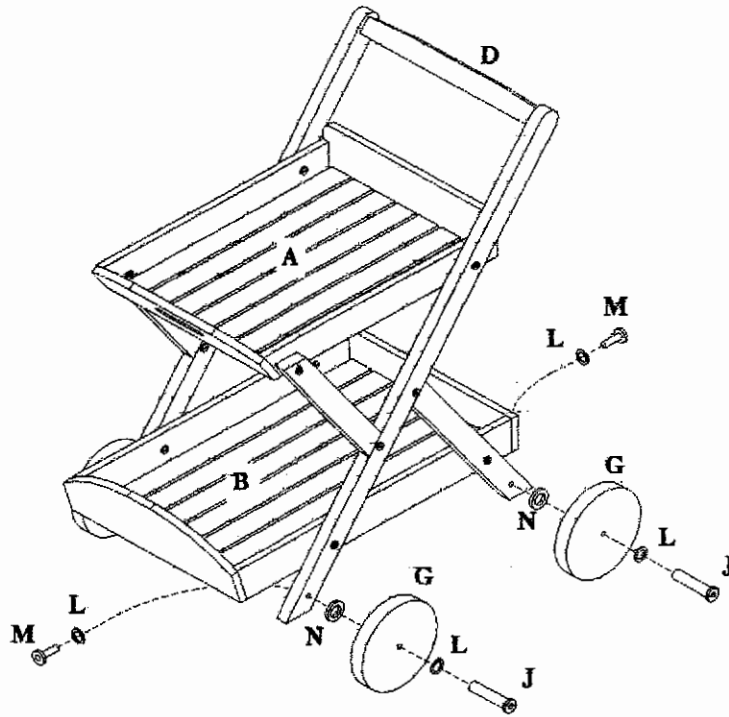



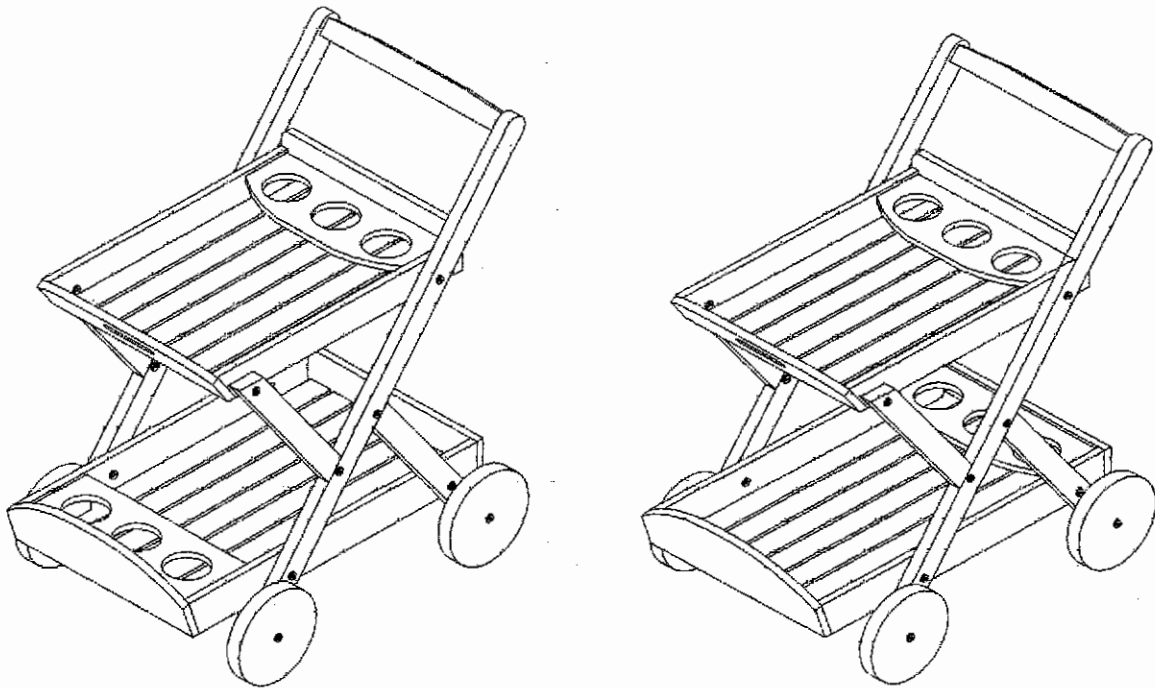





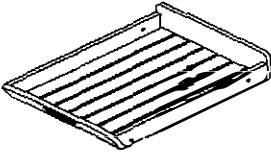
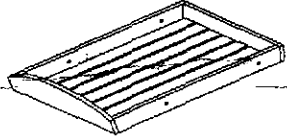

STEP 4

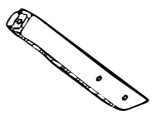

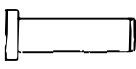
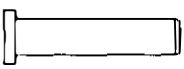
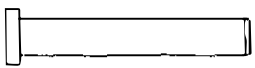
ASSEMBLY INSTRUCTIONS

TEAKWOOD TROLLEY BAR (ATF65)

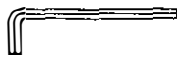
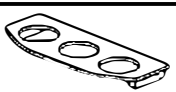
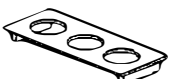
NO	PARTS	QTY
A	TOP TRAY 	1
B	BOTTOM TRAY 	1
C1+C2	LEGS. 	2
D	HANDLE 	1
E1+E2	FRONT LEGS SUPPORT 	2
F1+F2	BACK LEGS 	2
G	WHEELS 	4
H	SHORT SHAFT 	4
I	MEDIUM SHAFT 	8
J	LONG SHAFT 	4
K	NUT 	10
L	FIBER RING 	30
M	STUD 	4
N	BRASS RING 	4
O	HEXAGONAL WRENCH 	1
P	BOTTLE RACK (TOP) 	1
Q	BOTTLE RACK (BOTTOM) 	1