

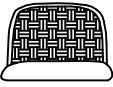









# LIST OF ACCESSORIES

1	 1PCS	2	 1PCS	3	 4PCS	4	 1PCS				
A	 8PCS	B	 4PCS	C	 4PCS	D	 1PCS	E	 4PCS	F	 4PCS

# ASSEMBLING STEPS

①

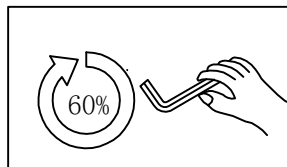
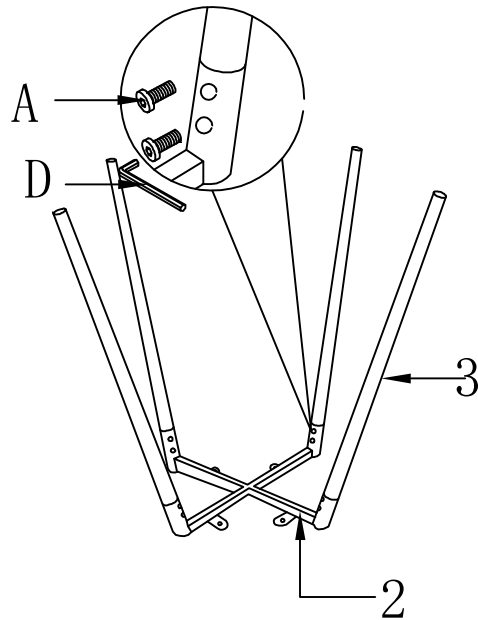

④

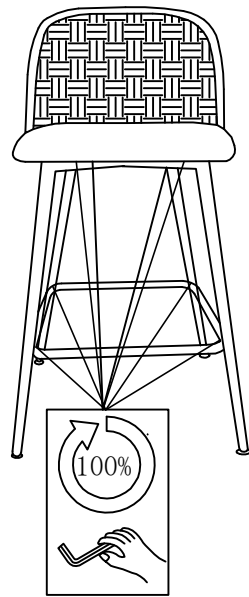

Place Chair on a totally flat surface and Re-tighten bolts again with 100% of required torque until all screws do not turn anymore

⑤

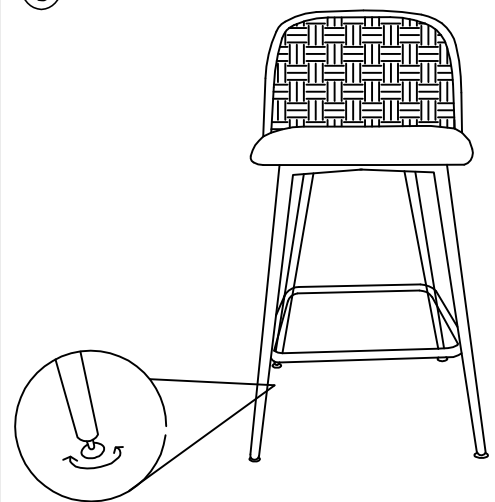

The four black plastic feet are adjusted, you can turn them and adjust its height to help to make the chair stable

