

STORAGE SHELTER

1.8X2.1 M  
6X7 FT

SKU:D-CW2367G012

# ASSEMBLY INSTRUCTIONS

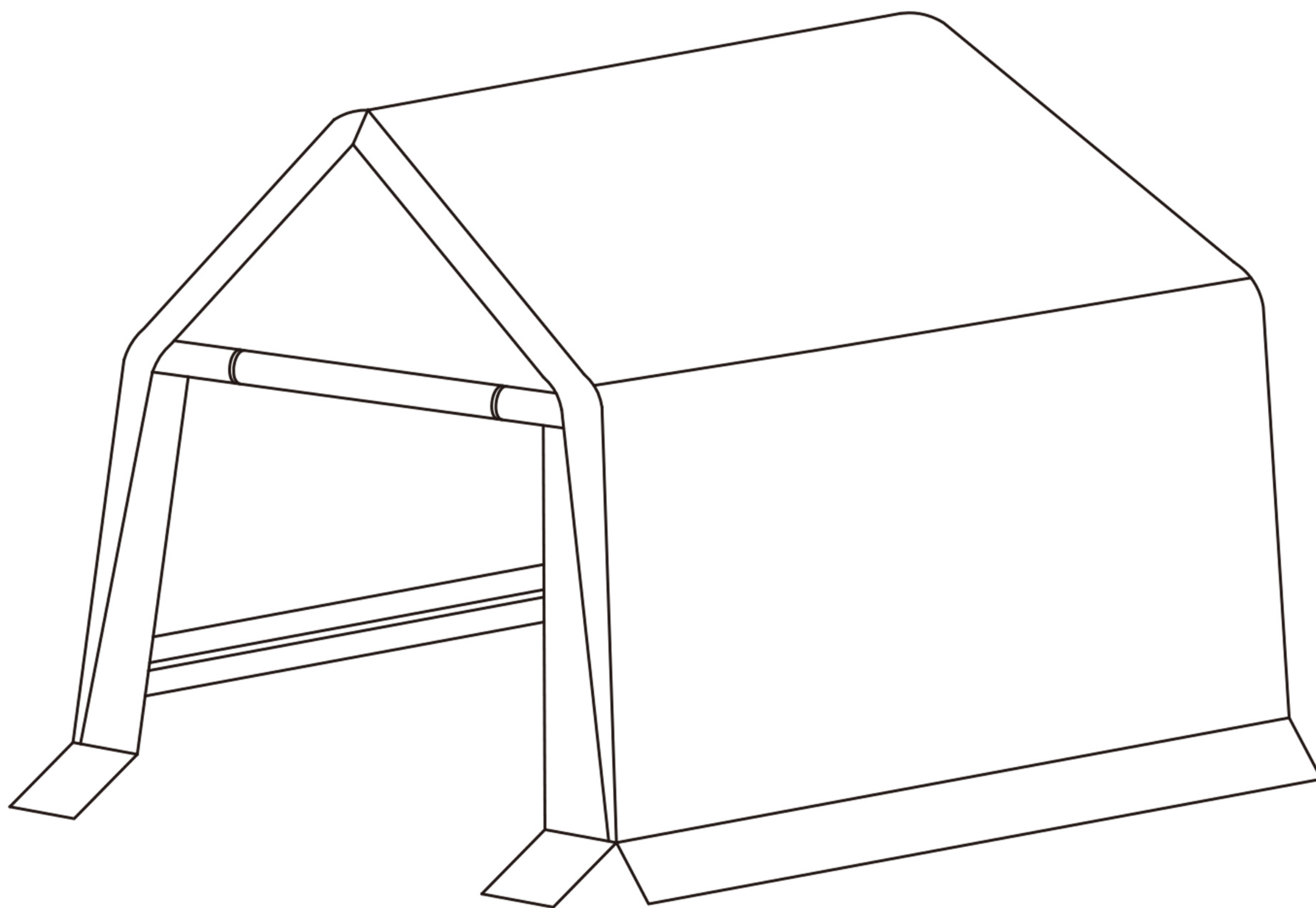

Please check the number of parts in the following accessory catalogue when unpacking. We have sent you more small parts for spare. If there is any missing or any questions about the installation. Please feel free to contact us. We will reply within 24 hours.



E-mail: [cs.helper01@gmail.com](mailto:cs.helper01@gmail.com)

## TOOLS RECOMMENDED

\*NOTE: The recommended tools are not included in boxes and need to be prepared by yourself.

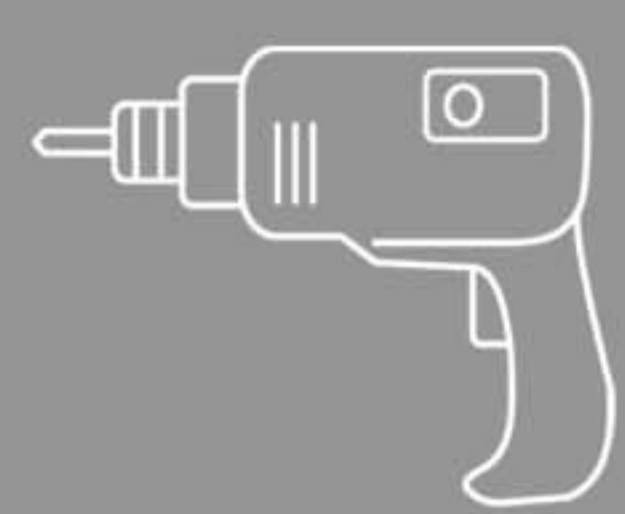

DRILL



RUBBER Mallet



STEPLADDER  
(6.5Ft Or More)



SAFETY HAT



GLOVES

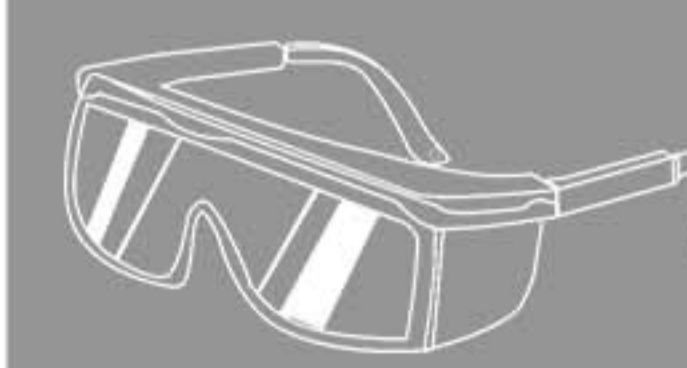

SAFETY GOGGLES

## ATTENTIONS



Since it is easy to lose many small accessories during the installation, please collect all the screw accessories before the assembly is completed



To better align the screws for practical situations, do not fully tighten screws initially



Please reinforced the Gazebo and do not use in heavy winds or inclement weather



Make sure all screws are tightened before use and check all screws, buckles and straps every 90 days

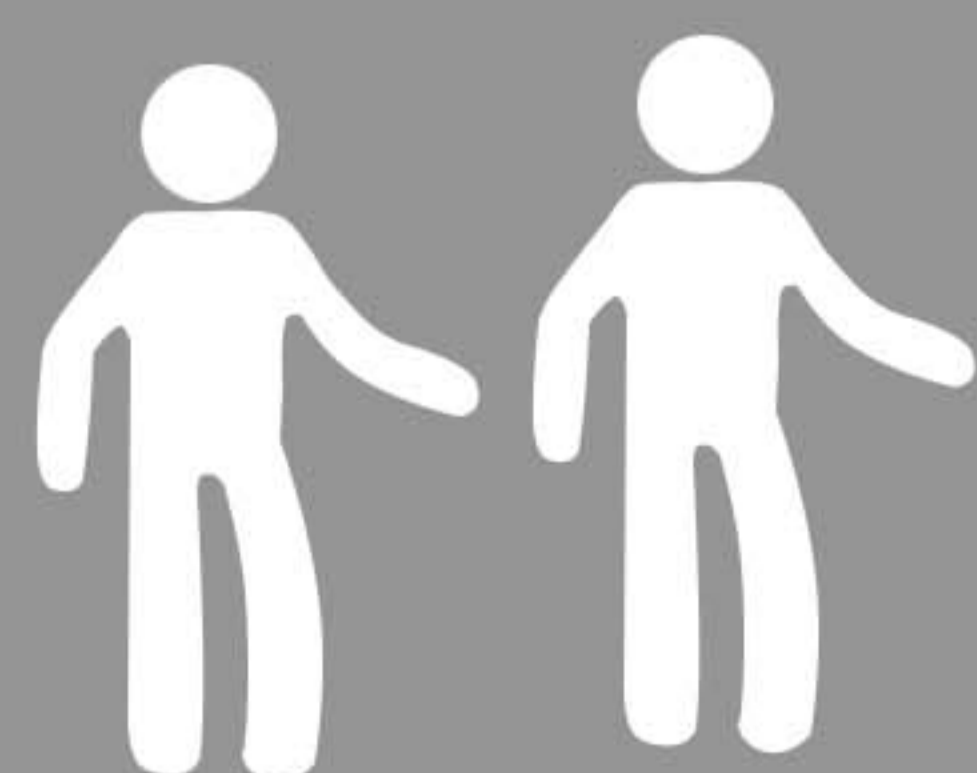

Two or more people are required for assembly



Please clear the snow off the roof in time for the heavy snowfall and do not use it



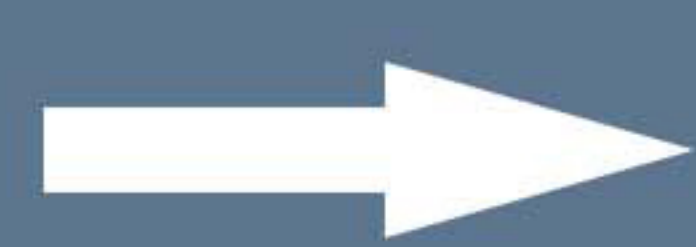









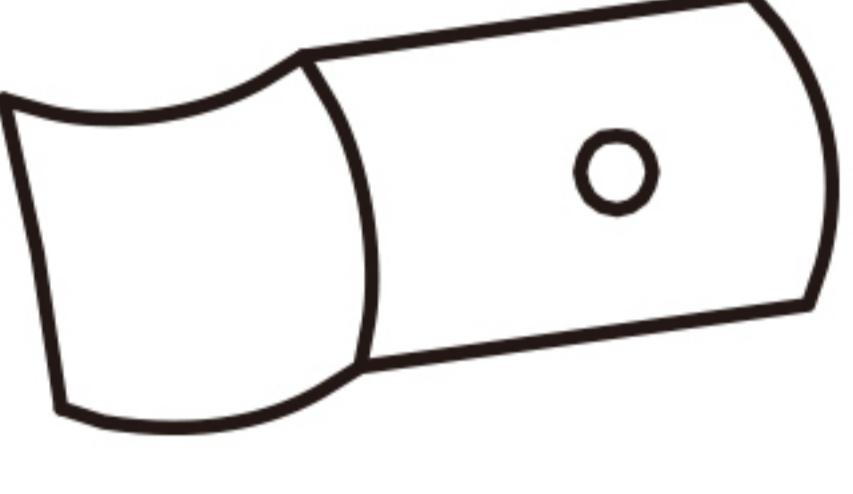

Please take care of the screws and contact the after-sales service if there is any problem with the installation or parts.



# ACCESSORY CATALOGUE

## BOX

SKU:D-CW2367G012

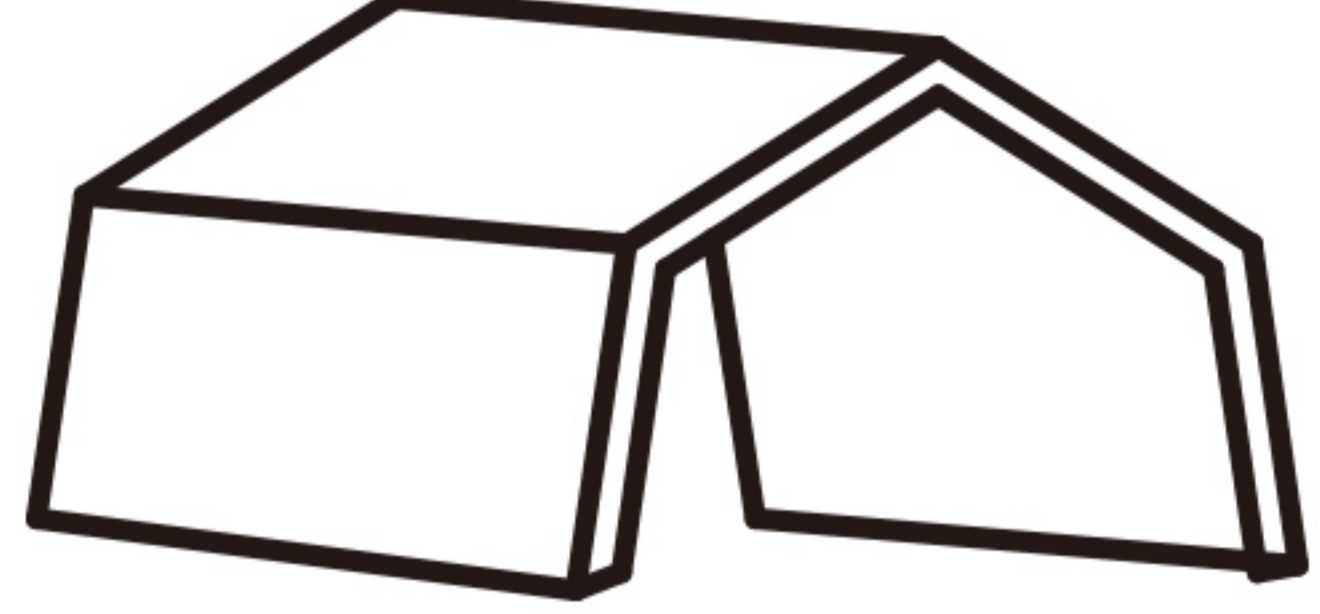

Item no.	Reference Image	Qty.	Item no.	Reference Image	Qty.
1		4	C		4
2		3	D		8
2A		3	E	 $\phi 5*250\text{mm}$	4
3		4	F#		28
3A		4	H	 M6 × 40	4
4		2	I	 $\phi 4.8$	12
4A		2	J	 $\phi 5$	4
A		6	K		1



Check and make sure you get the components on the list, contact us for any missing

Please take care of the screws and contact the after-sales service if there is any problem with the installation or parts.

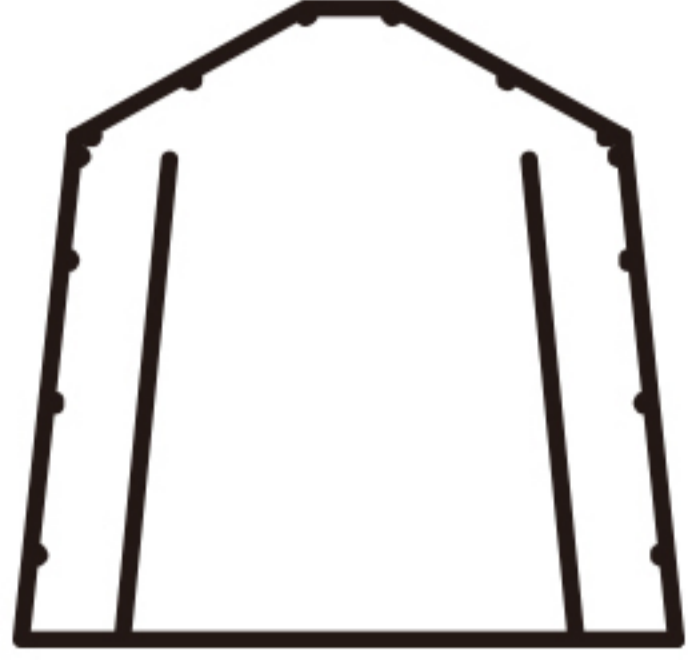
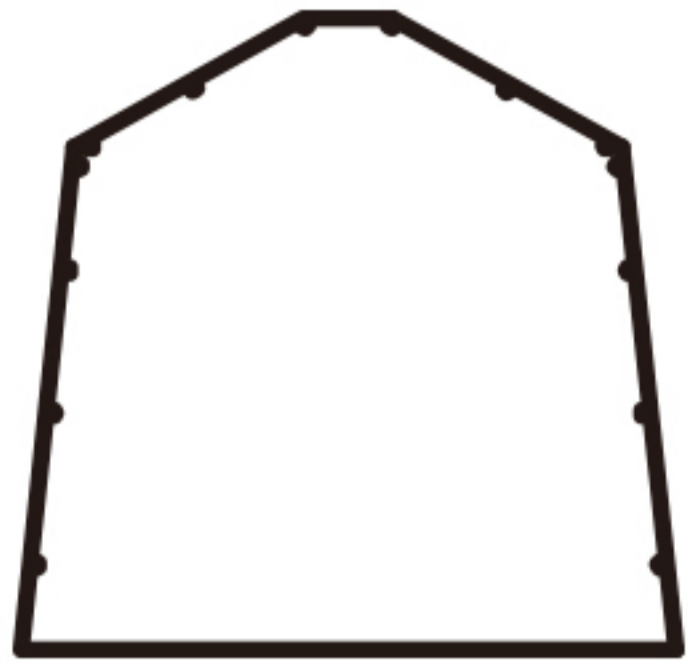
→  E-mail: [cs.helper01@gmail.com](mailto:cs.helper01@gmail.com)

# ACCESSORY CATALOGUE

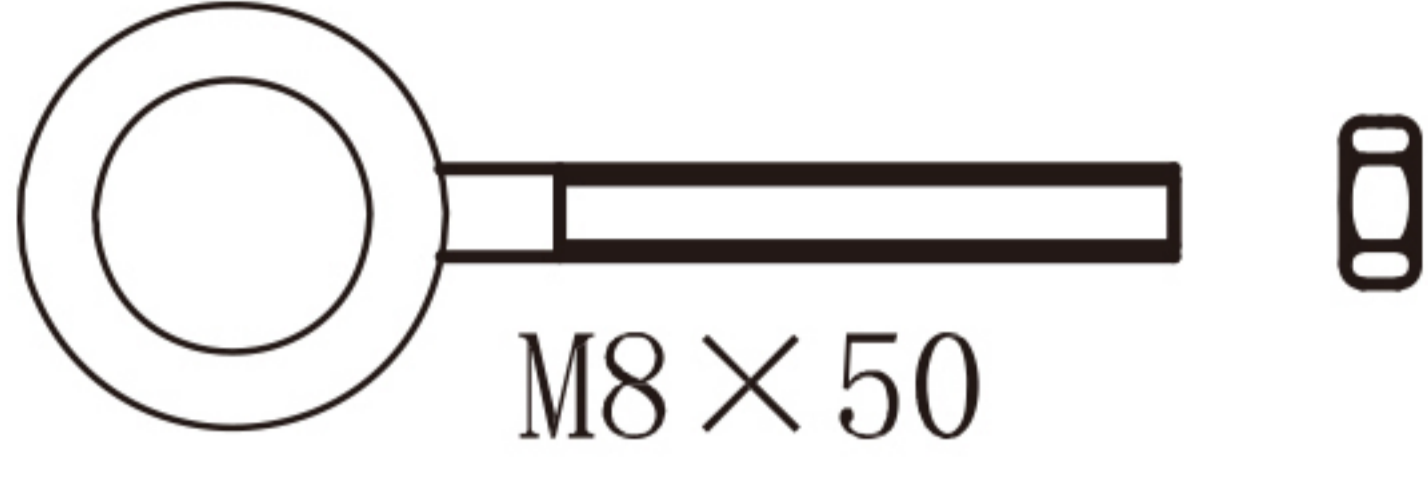
Item no.	Reference Image	Qty.
<b>K1</b>		<b>1</b>
<b>K2</b>		<b>1</b>
<b>L</b>		<b>4</b>

Item no.	Reference Image	Qty.
<b>M</b>		<b>4</b>
		<b>2</b>

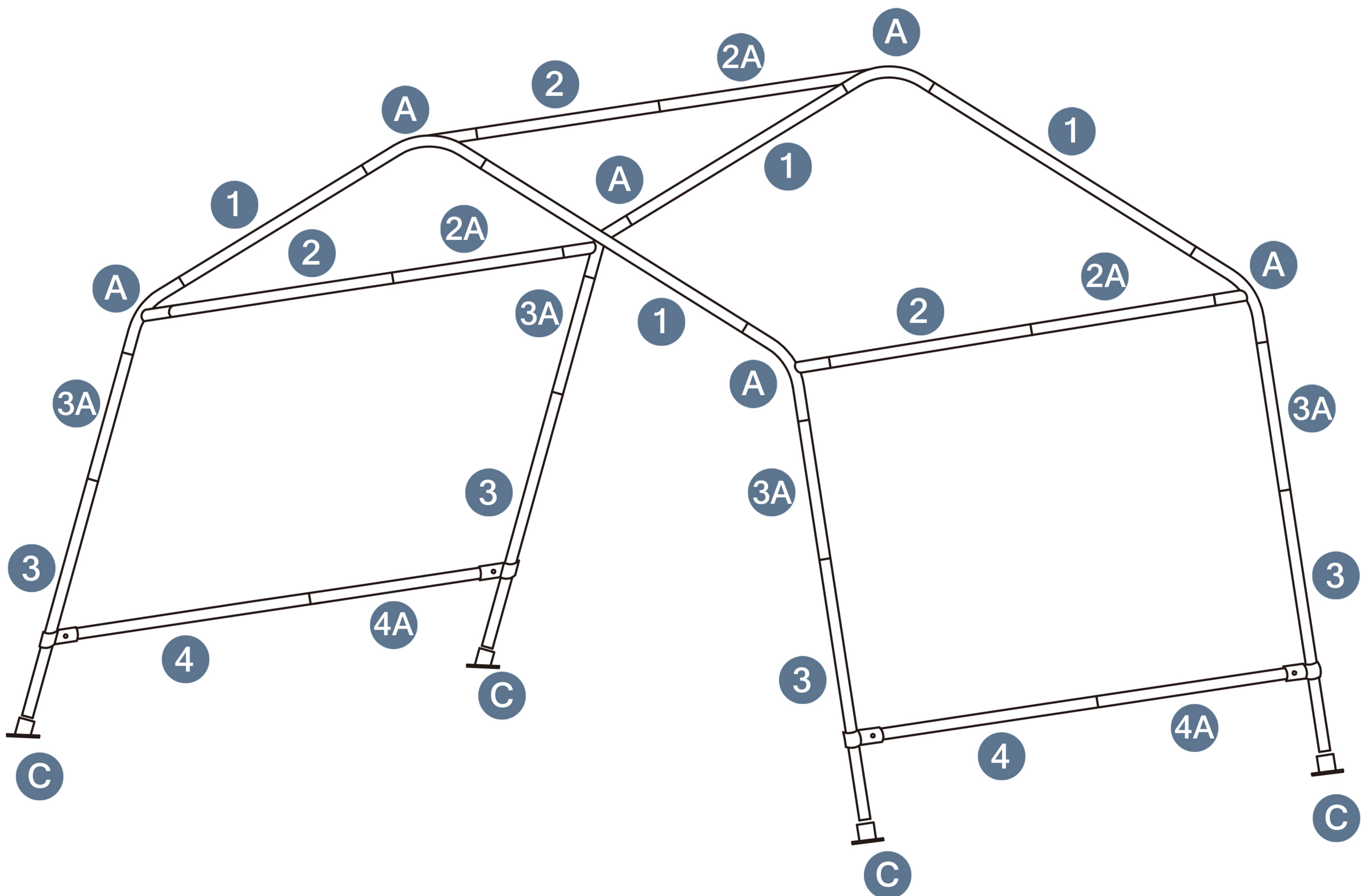

Please take care of the screws and contact the after-sales service if there is any problem with the installation or parts.

# STEP 1

Parts required

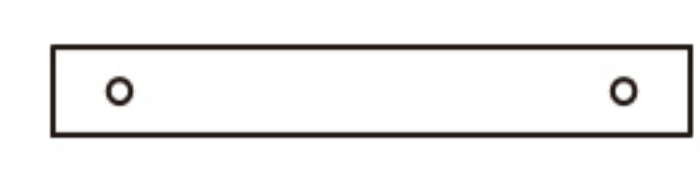

1 4pcs

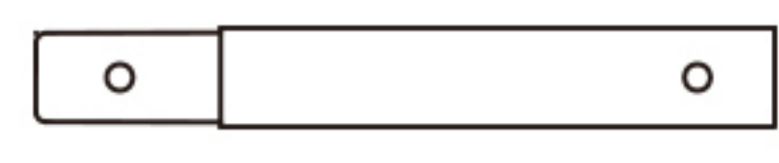

2 3pcs



A 6pcs

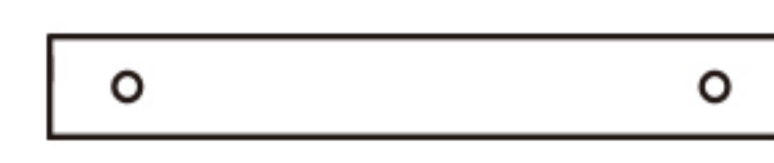

2A 3pcs

For convenience, please place each accessory according to the position shown in the figure, and then start to build.

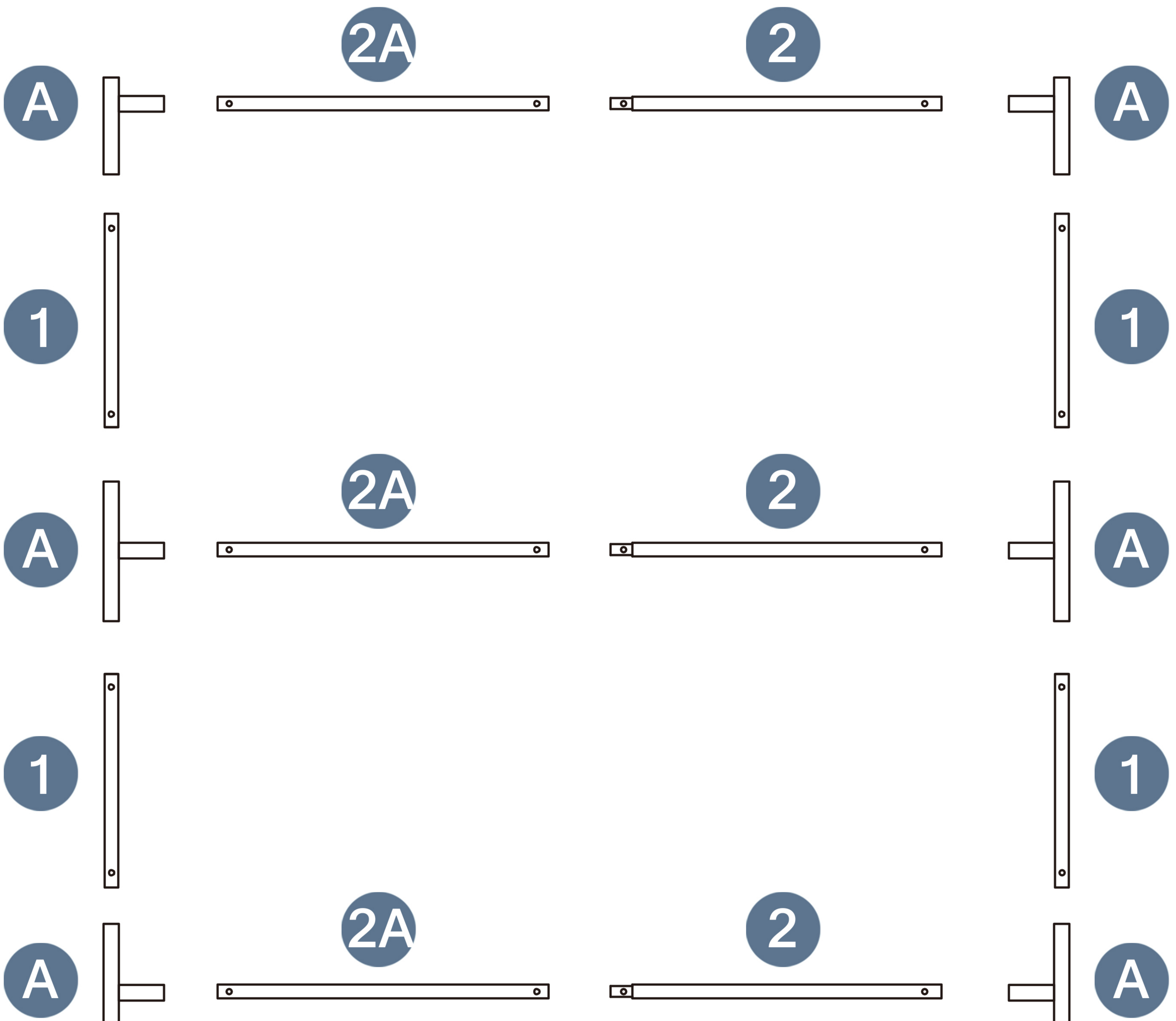

Please take care of the screws and contact the after-sales service if there is any problem with the installation or parts.



E-mail: [cs.helper01@gmail.com](mailto:cs.helper01@gmail.com)

# STEP 2

Parts required

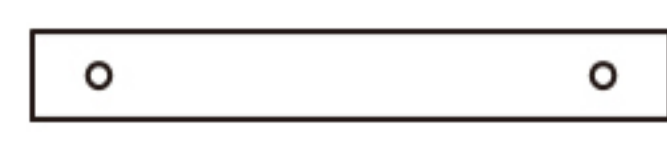

1 4pcs

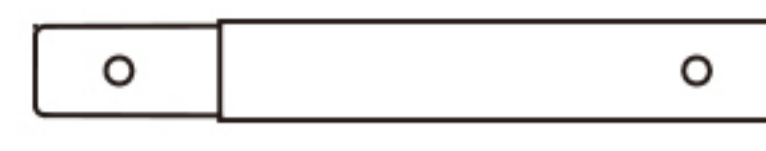

2 3pcs



A 6pcs

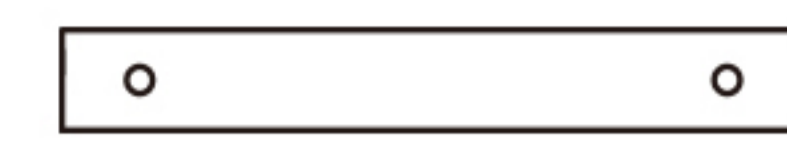

2A 3pcs

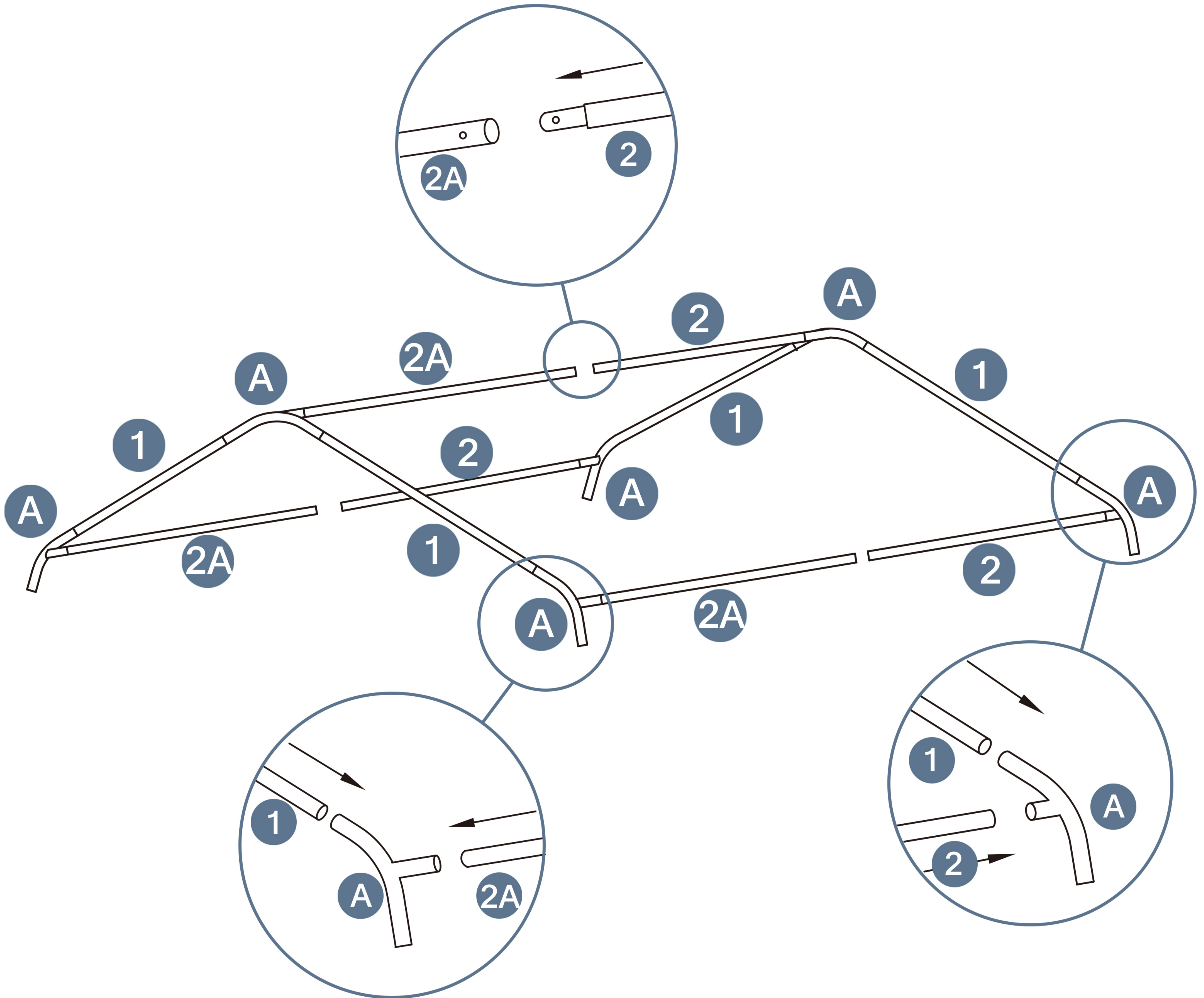

Please take care of the screws and contact the after-sales service if there is any problem with the installation or parts.



# STEP 3

Parts required

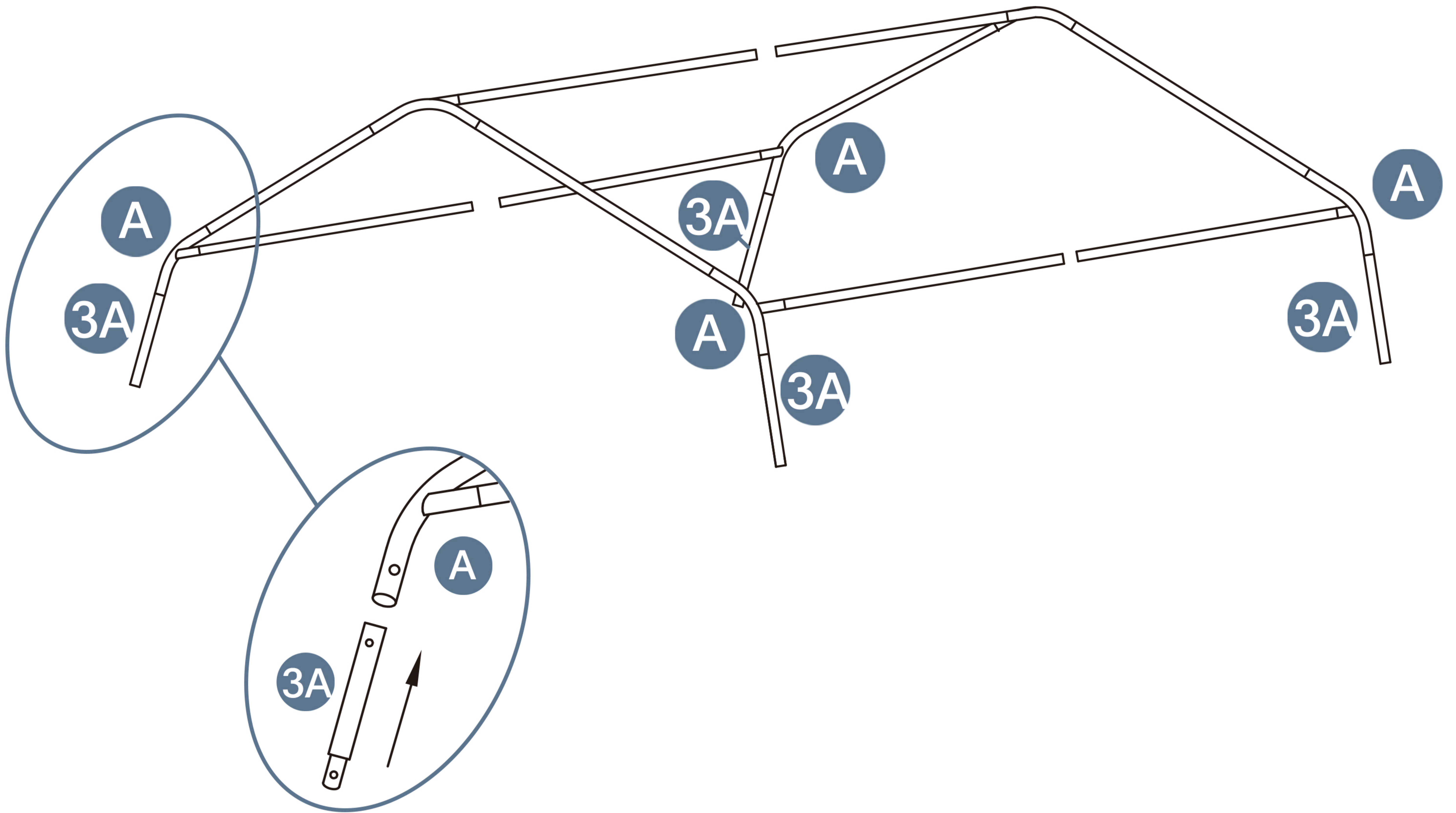

Please take care of the screws and contact the after-sales service if there is any problem with the installation or parts.

➔ ✉ E-mail: [cs.helper01@gmail.com](mailto:cs.helper01@gmail.com)

# STEP 4

Parts required

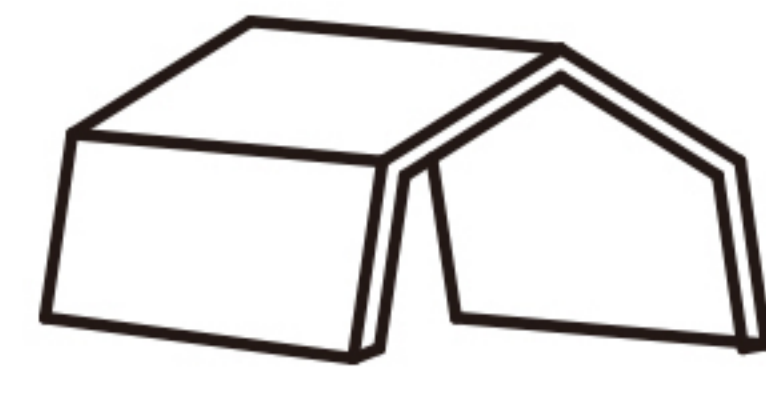

**K** 1pcs

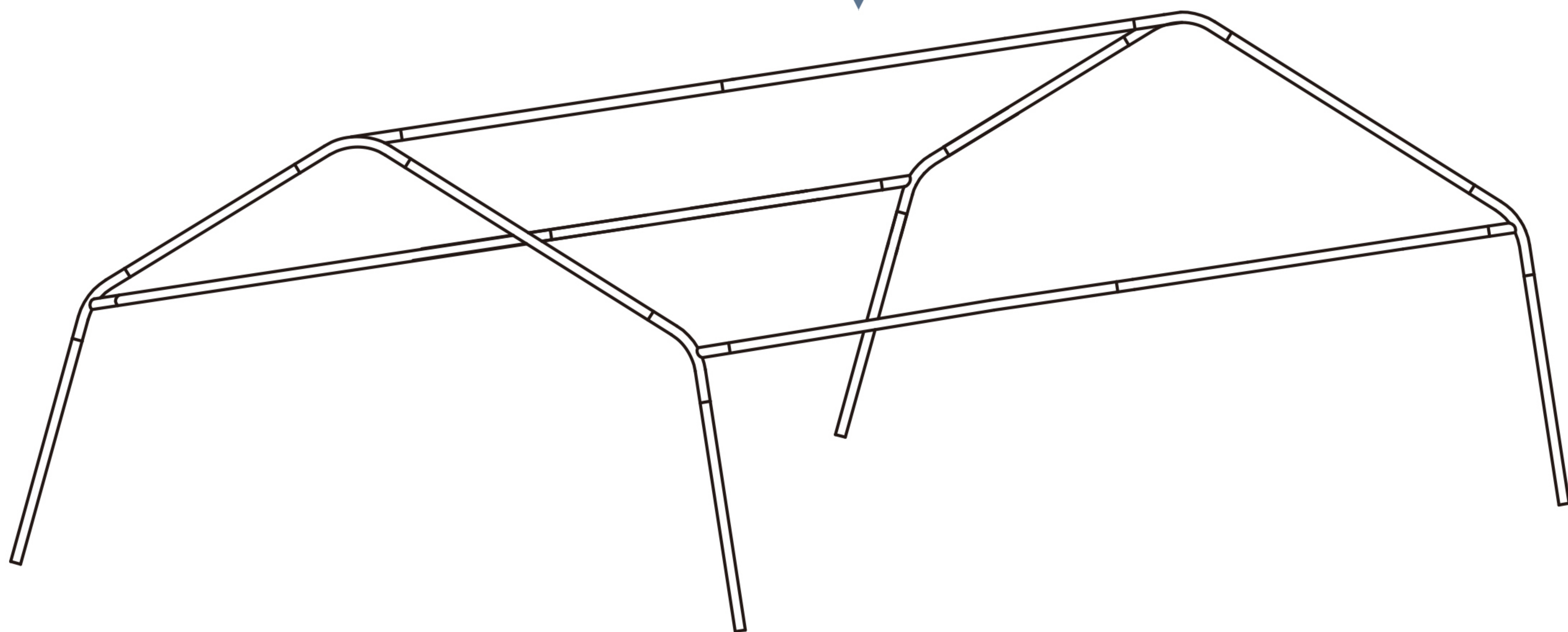
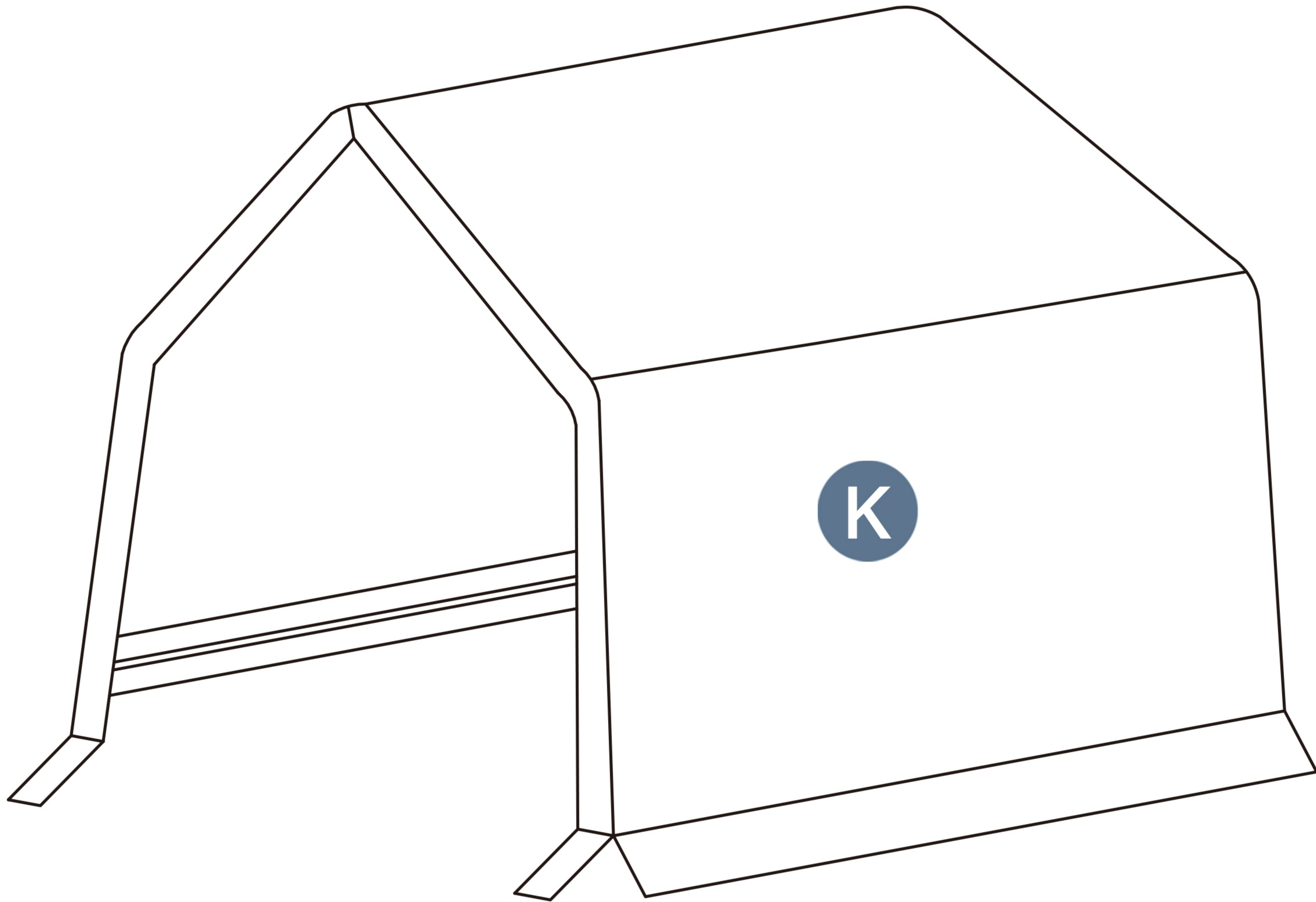

Please take care of the screws and contact the after-sales service if there is any problem with the installation or parts.



# STEP 5

Parts required



**K1** 1pcs



**F#** 14pcs

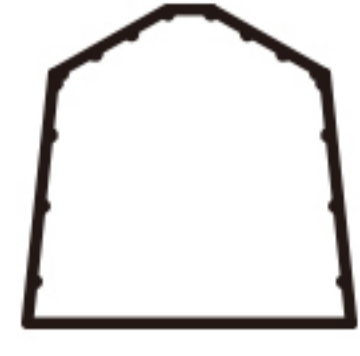

**K2** 1pcs

Fix the top canopy **K** and front door **K1** to #1 with elastic cords via pre-drilled holes. Secure the rear door **K2** in the same way.

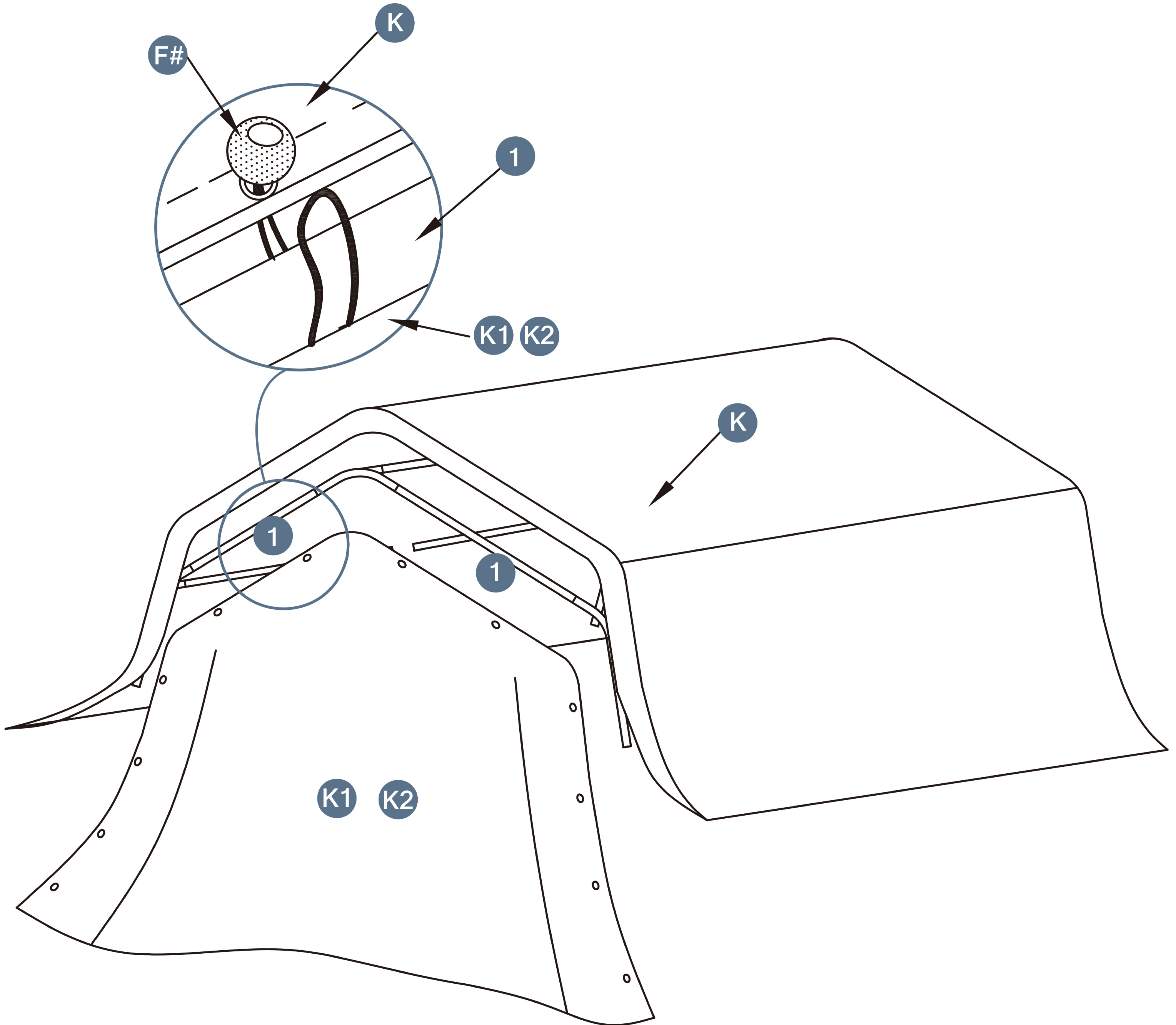

Please take care of the screws and contact the after-sales service if there is any problem with the installation or parts.



E-mail: [cs.helper01@gmail.com](mailto:cs.helper01@gmail.com)

# STEP 6

Parts required

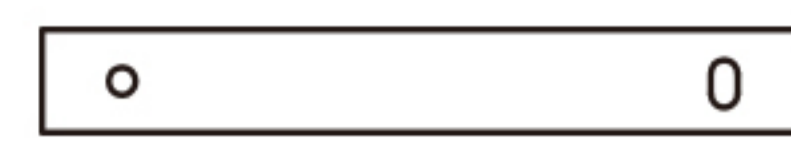

3 4pcs

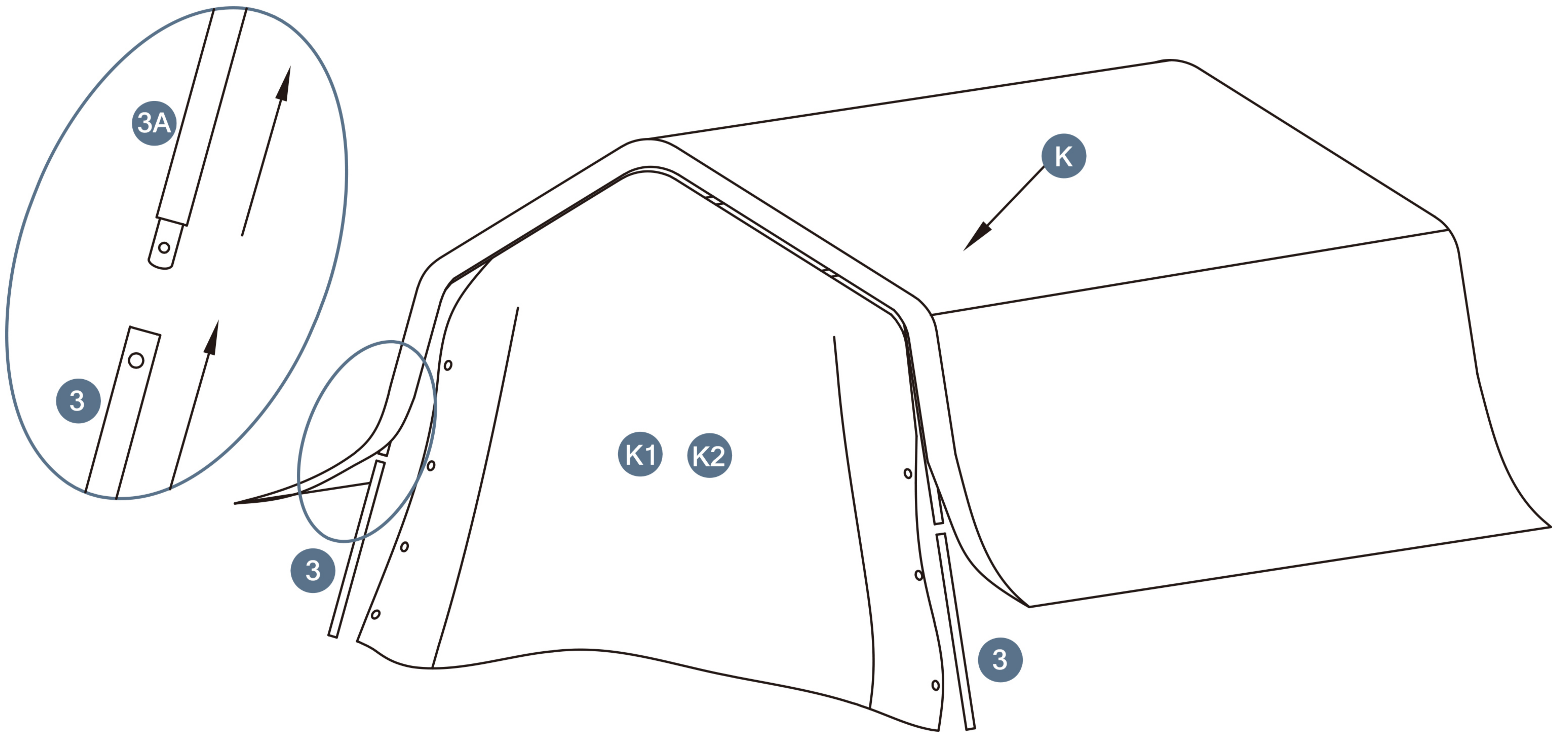

Please take care of the screws and contact the after-sales service if there is any problem with the installation or parts.



# STEP 7

Parts required



**C** 4pcs



**F#** 14pcs



**M** 4pcs

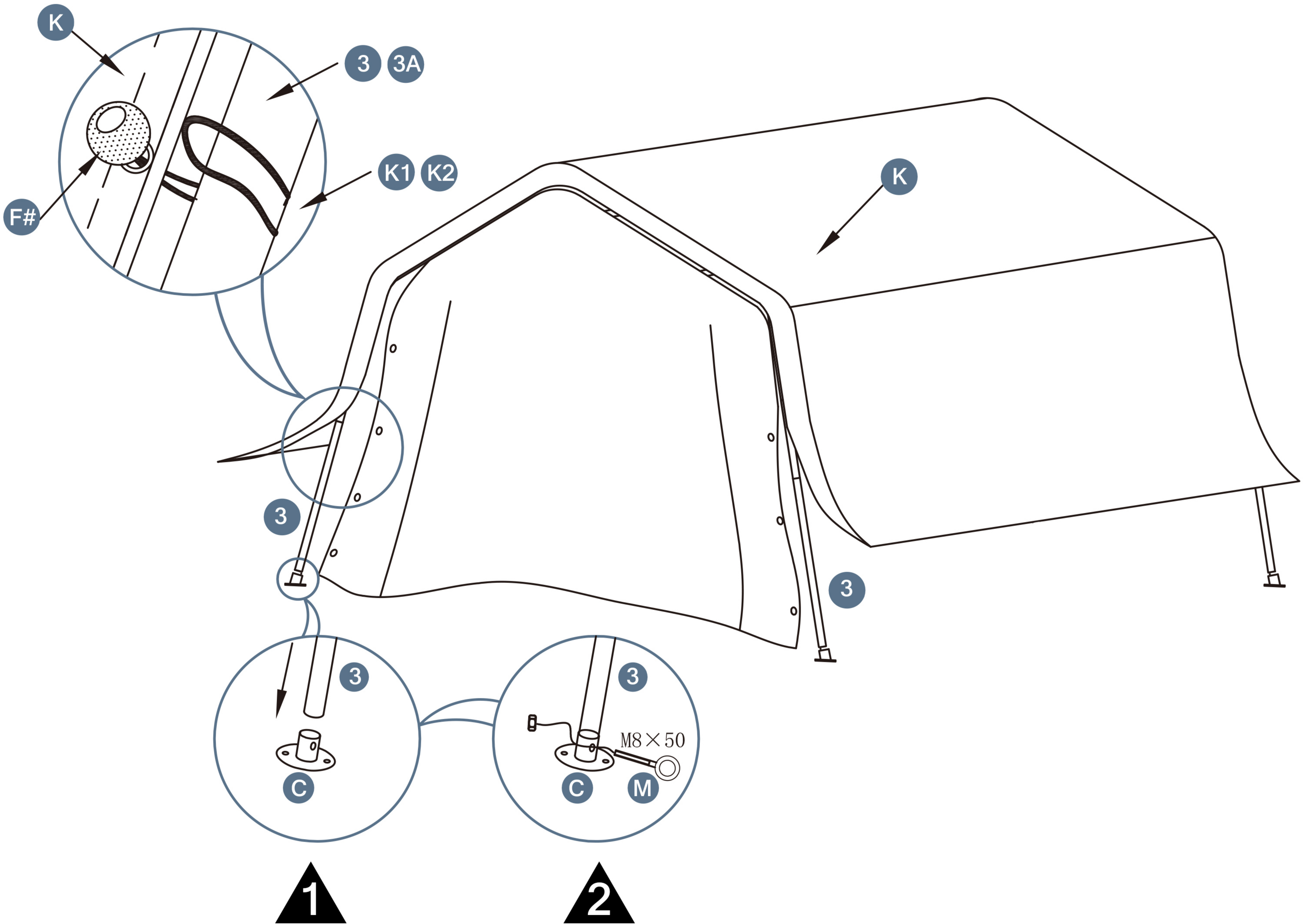

Please take care of the screws and contact the after-sales service if there is any problem with the installation or parts.



E-mail: [cs.helper01@gmail.com](mailto:cs.helper01@gmail.com)

# STEP 8

Parts required

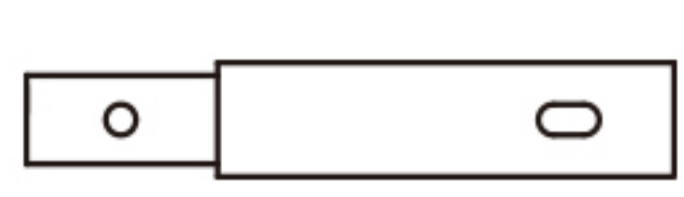

**4** 2pcs



**D** 8pcs

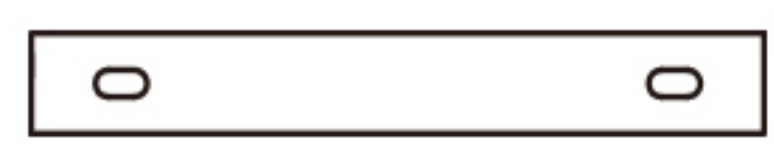

**4A** 2pcs



**H** 4pcs

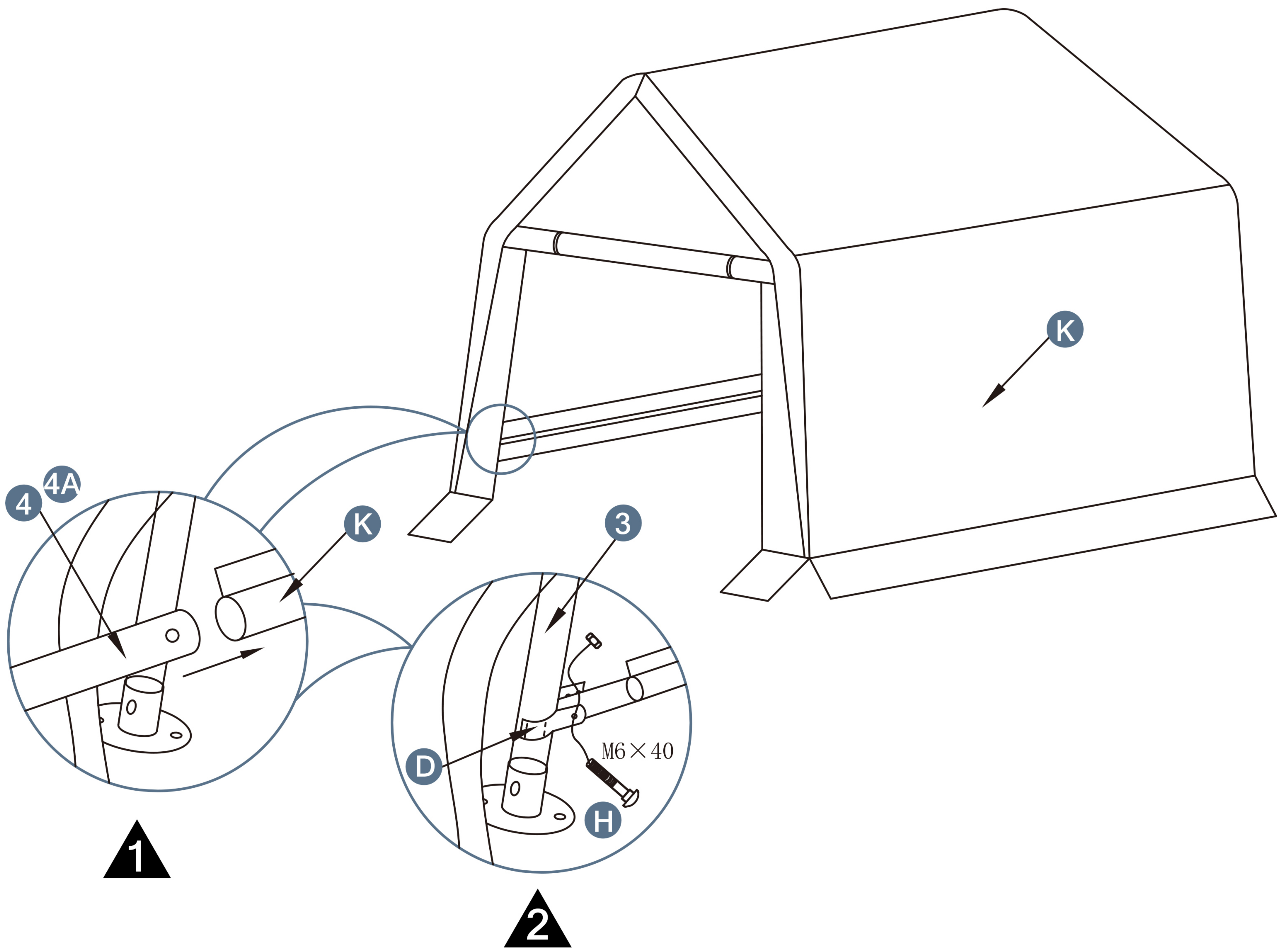

Please take care of the screws and contact the after-sales service if there is any problem with the installation or parts.



# STEP 9

Parts required



L 4pcs

Secure the end of the top tarp **K** using the fastening devices **L**

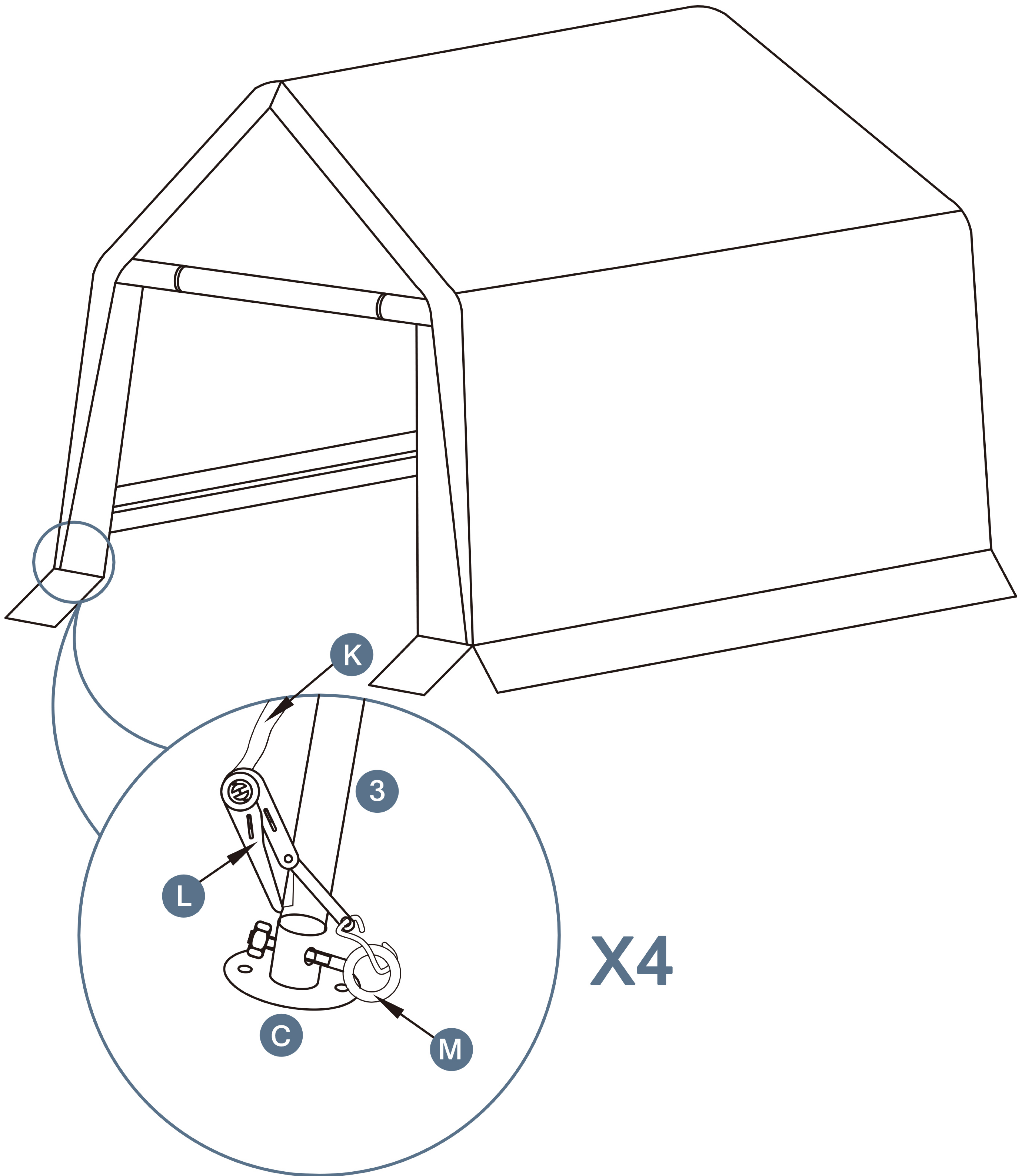

Please take care of the screws and contact the after-sales service if there is any problem with the installation or parts.



E-mail: [cs.helper01@gmail.com](mailto:cs.helper01@gmail.com)

# STEP 10

Parts required

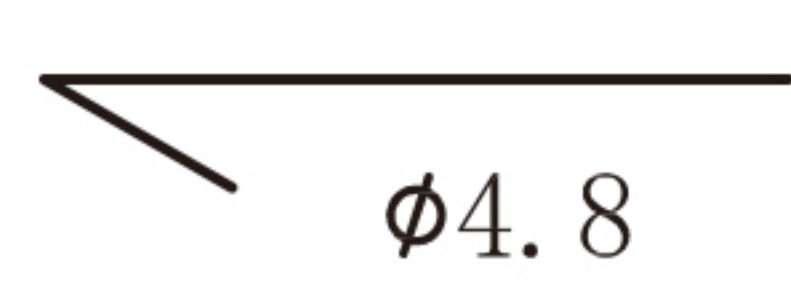

I 12pcs

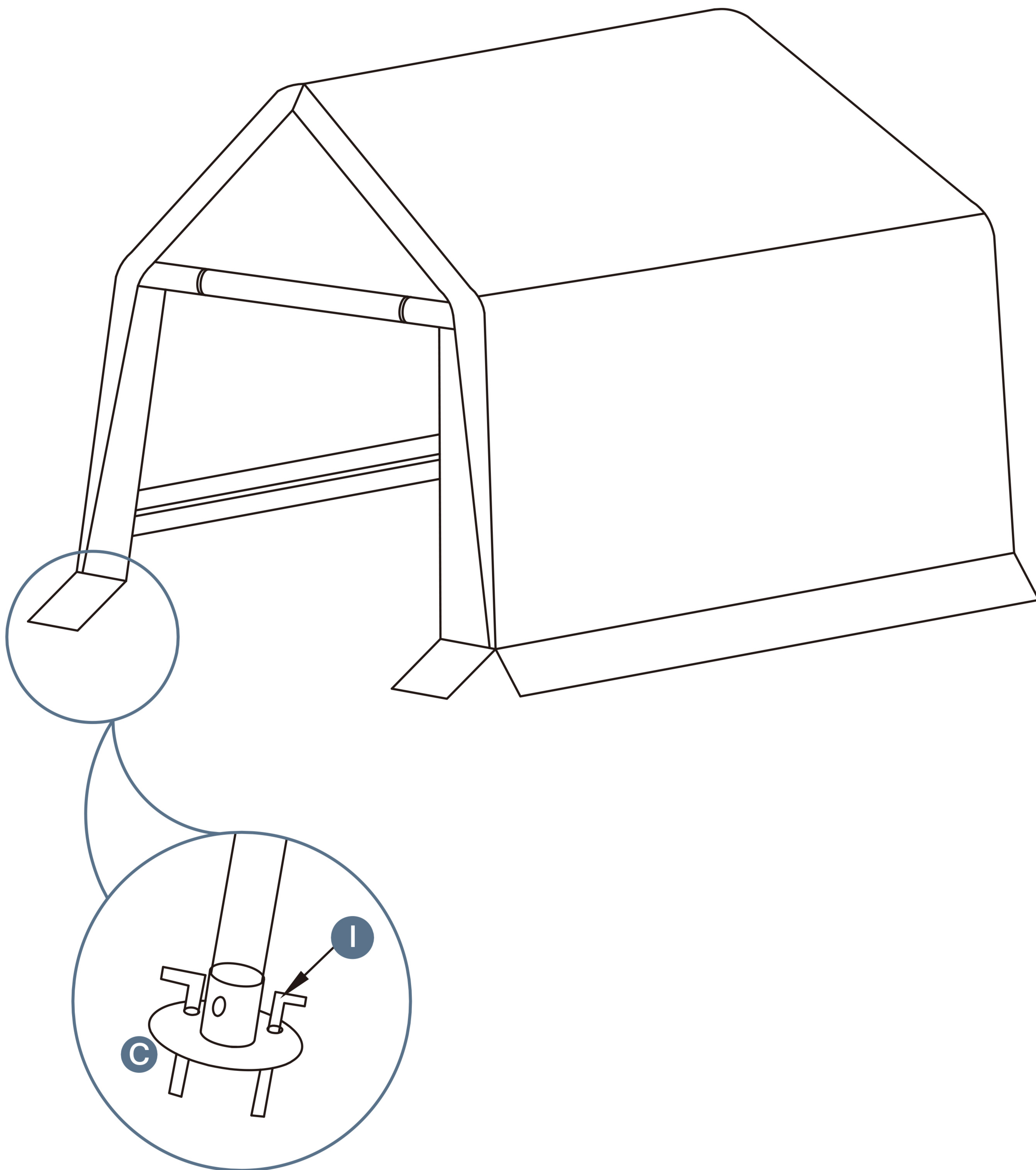

Please take care of the screws and contact the after-sales service if there is any problem with the installation or parts.

# STEP 11

Parts required

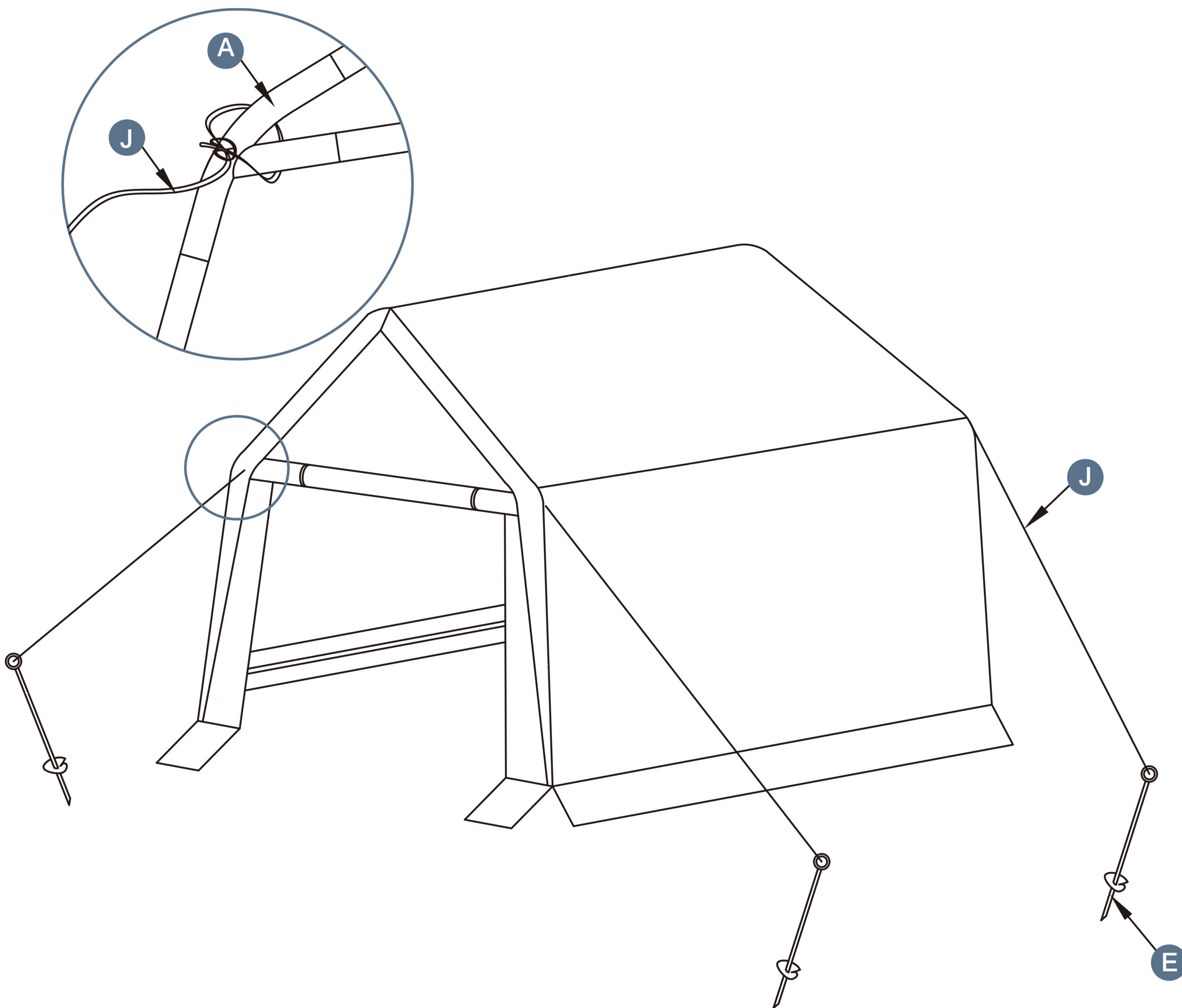

Please take care of the screws and contact the after-sales service if there is any problem with the installation or parts.



E-mail: [cs.helper01@gmail.com](mailto:cs.helper01@gmail.com)

**Hope you enjoy this product.**

If you have any concerns about gazebo Installation, please feel free to contact us. We will reply within 24 hours.



E-mail: [cs.helper01@gmail.com](mailto:cs.helper01@gmail.com)