

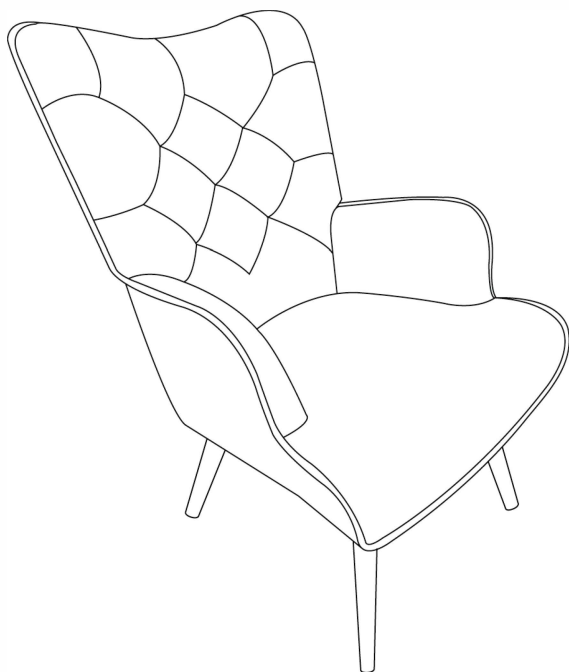

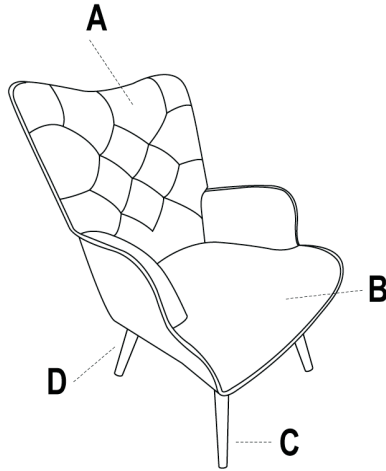

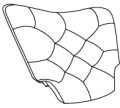

Patchwork Armchair



Assembly Instructions

Please remain these instructions for future reference.



A Seat Back  x1	B Seat Bottom  x1	C Front Legs  x2
D Back Legs  x2	E Washers  x2	F Short Bolts  x12
G Long Bolts  x2	H Allen Wrench  x1	

1

Take all the components out of the carton.
Turn the Seat Bottom(B) upside down.
Install the Back Legs(D) to the back of the chair
and Install the Front Legs(C) to the front of the chair.
Screw the Legs(C&D) with the Short Bolts(F),
and tighten the Short Bolts(F) fully by using Allen Wrench(H).

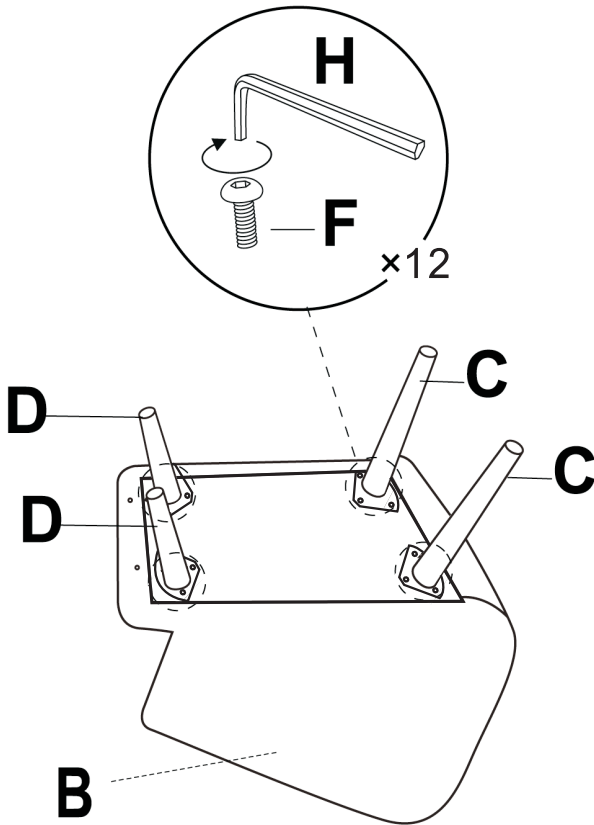

2

Turn the chair up. Line up the plugs of the Seat Back(A) with the holes on the armrests of Seat Bottom(B).

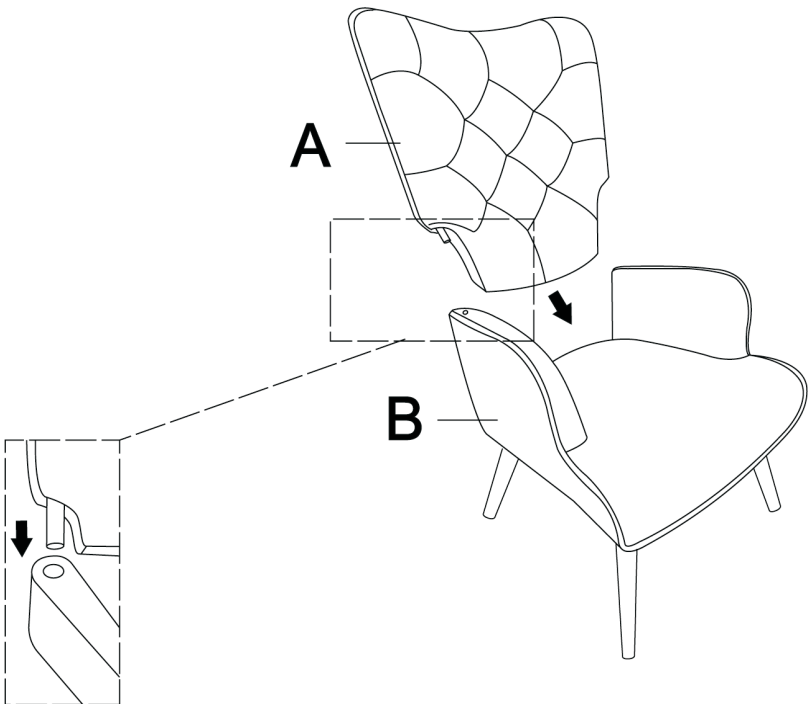

There are 2 plugs on the bottom of the Seat Back(A), and 2 holes on the armrests of the Seat Bottom(B).

3

Align the Seat Back(A) with two arms, and insert the Seat Back(A) to the Seat Bottom(B).

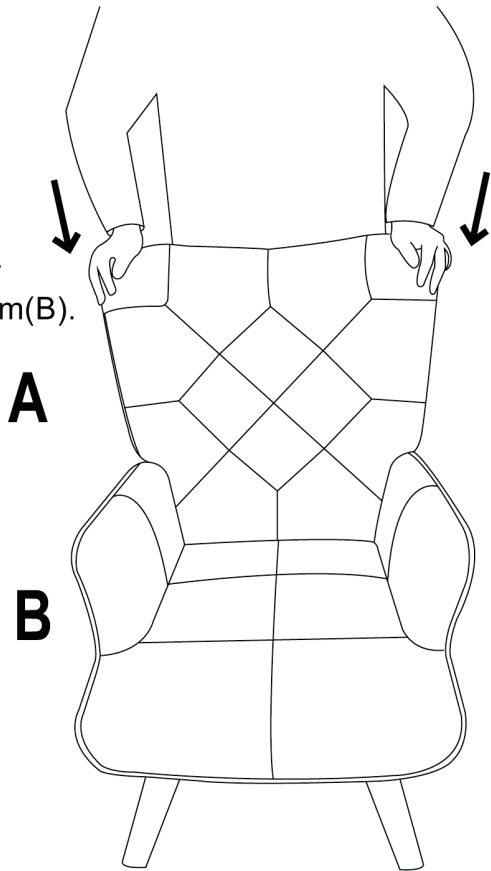

Hold the Seat Back(A) firmly and insert to the Seat Bottom(B).

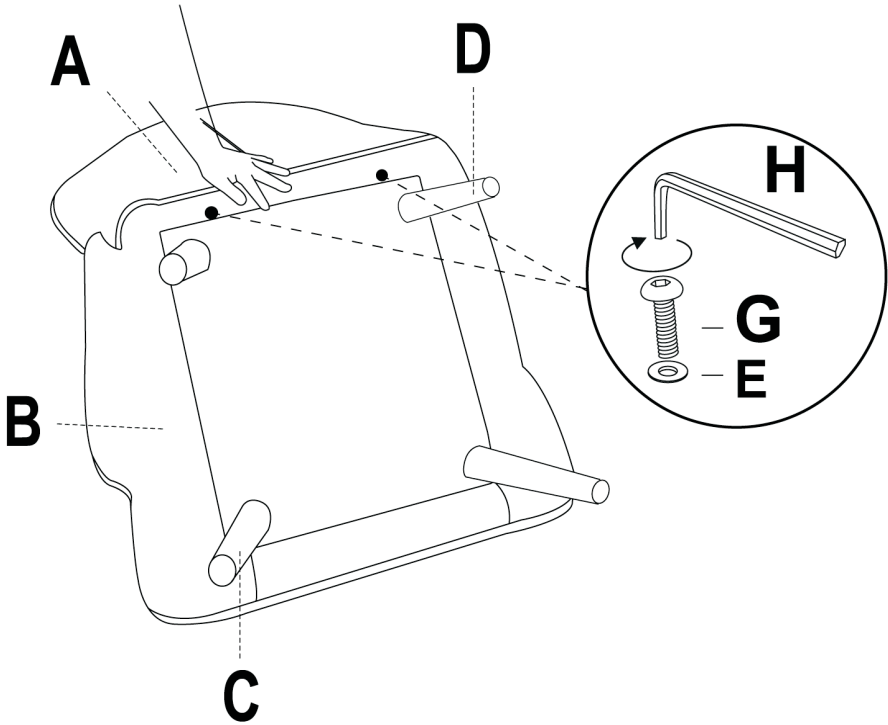

4

After fitting the Seat Back(A) and Seat Bottom(B), lie the chair down. Place a Washer(E) on each of Long Bolts(G), and insert E&G together into the two holes on Seat Bottom(B) near the Back Legs(D). Tighten them fully by using Allen Wrench(H).



E		2PCS
G		2PCS