

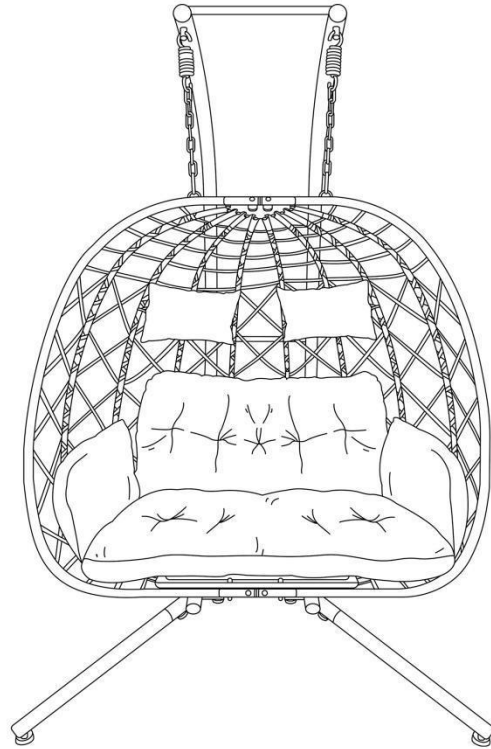









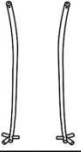

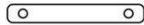



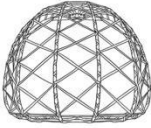
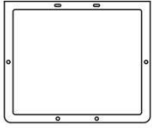

Double Egg Swing Chair

Installation Instructions



Feel free to contact Installation Instructor Team!

Parts List

Parts List										
Chair Components										
	A-left	A-right	B	2	C	4	D	1	E	1
									 reinforcement	
	F	1	G	1	H	1	I	1	J	6
			 height adjuster							
	L	2	N	4	O	2	P	2	Q	2
Accessories & Tools	M-6 		M-6  M-8 							
	R	2	S	1	M-8,60mm	2	M-8,20mm	4	M-6,40mm	10

Step 1:

Screw the 4 height adjusters (H) into the ends of the 4 support legs (C)

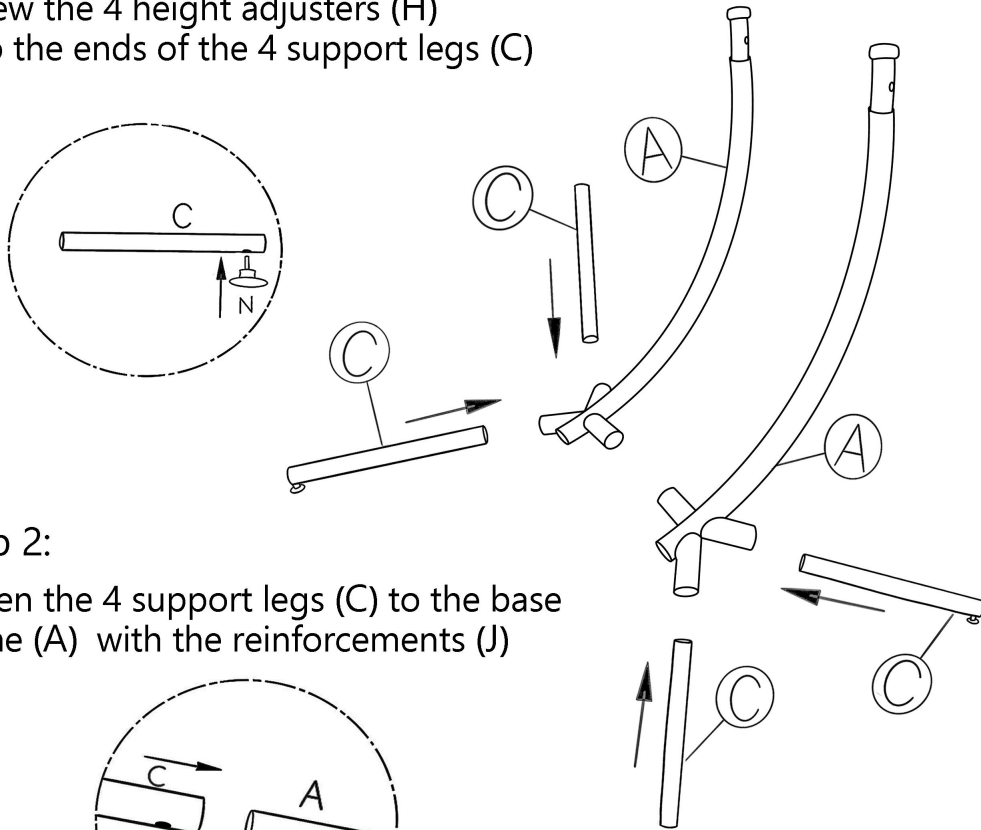

Step 2:

Fasten the 4 support legs (C) to the base frame (A) with the reinforcements (J)

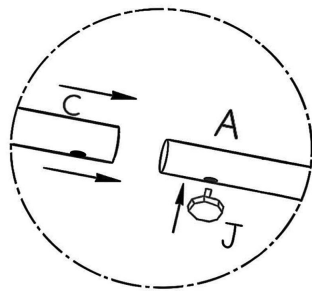

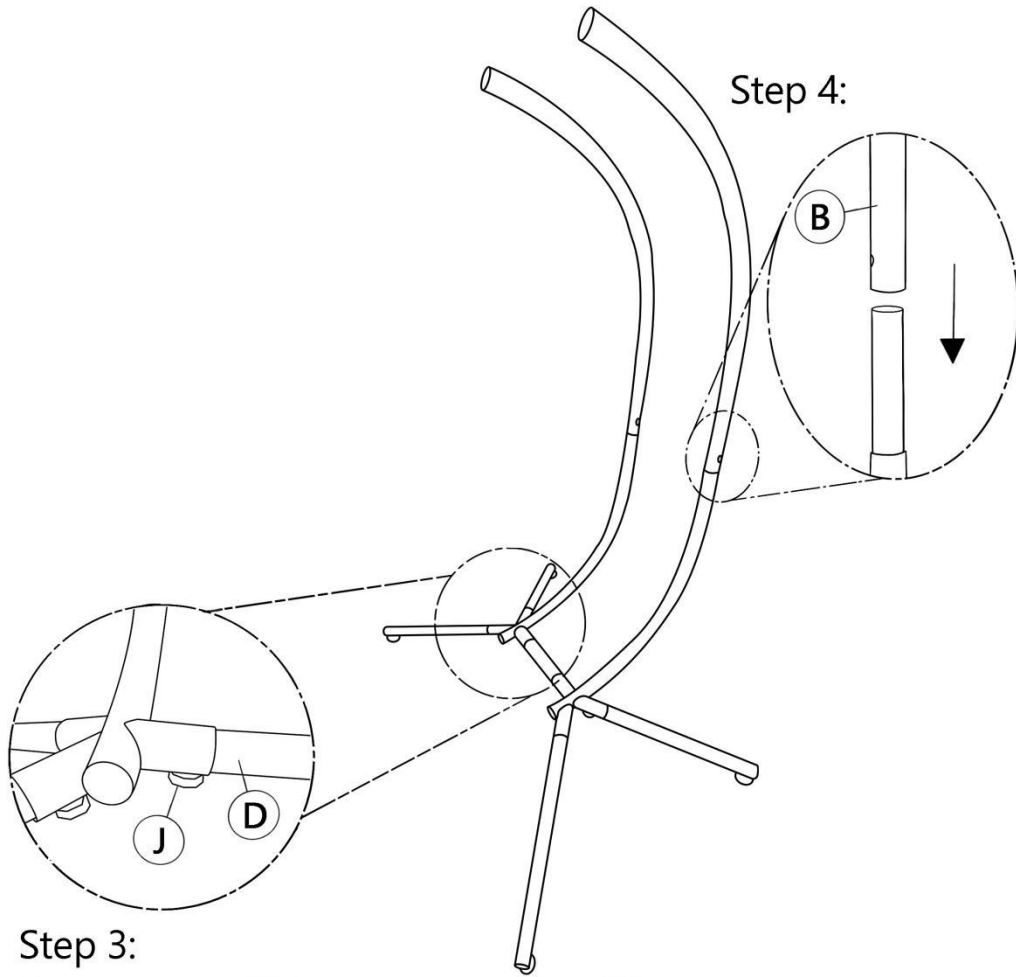

Step 4:

Step 3:

Use accessory (J) to secure accessory (D) to the chair frame (A).

Step 5:
Use two screws (M-8,60mm)
to secure accessories (B) and (E).

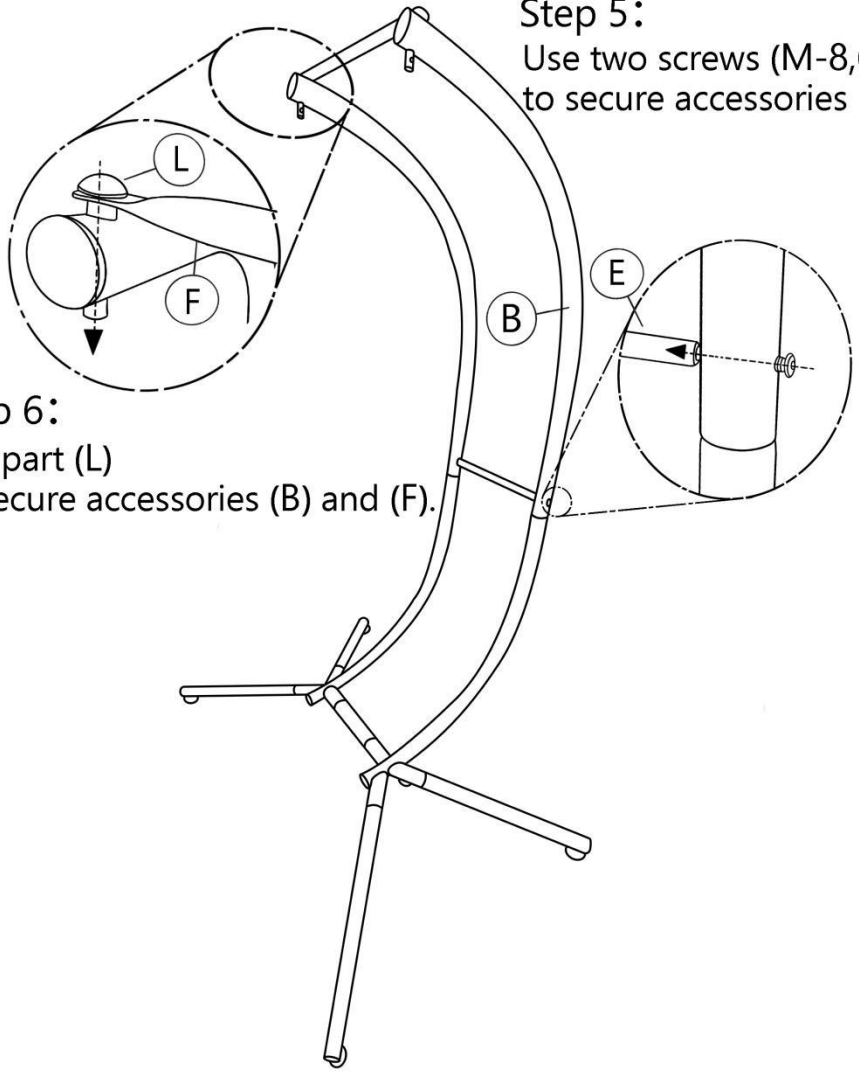

Step 6:
Use part (L)
to secure accessories (B) and (F).

Step 7: Simply flip the chair base (H) over.

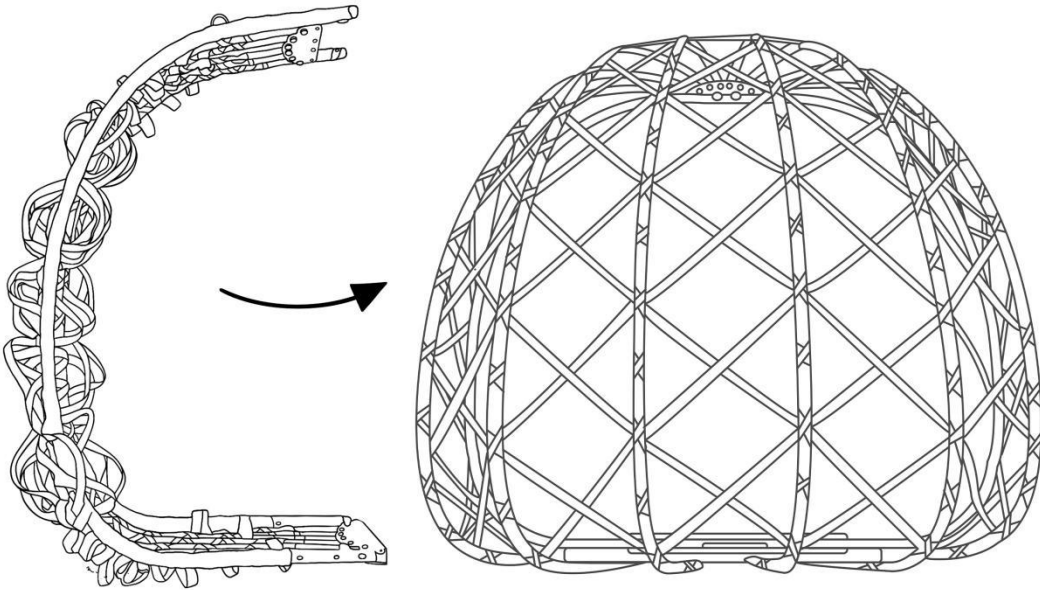

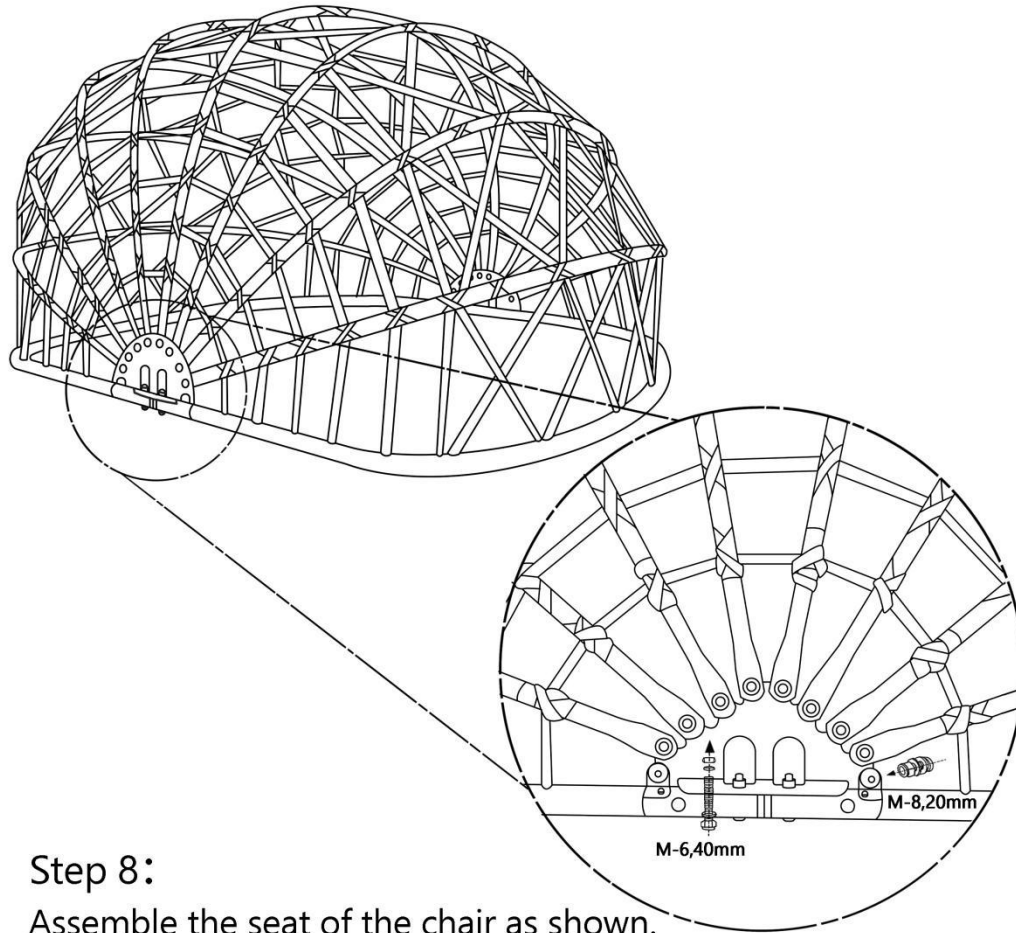

Step 8:
Assemble the seat of the chair as shown.

Installation of 2 (M-8,20mm), 2 (M-6,40mm)

Step 9:

Installation of 2 (M-8,20mm)

2 (M-6,40mm)

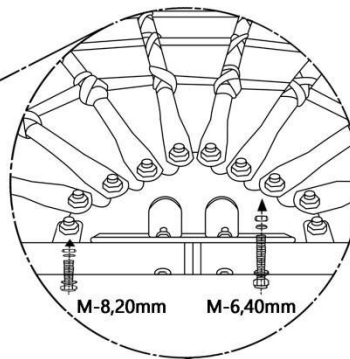
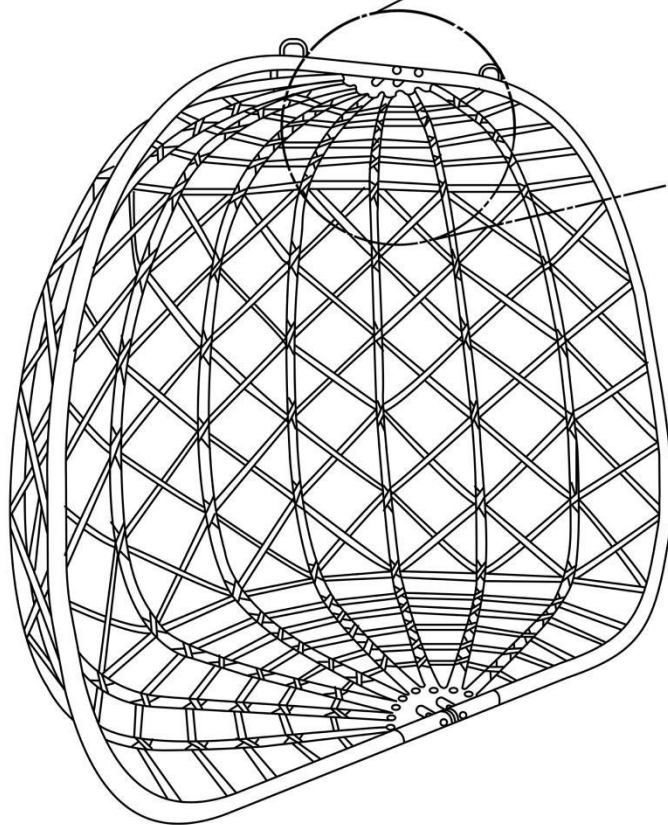

Step 10:

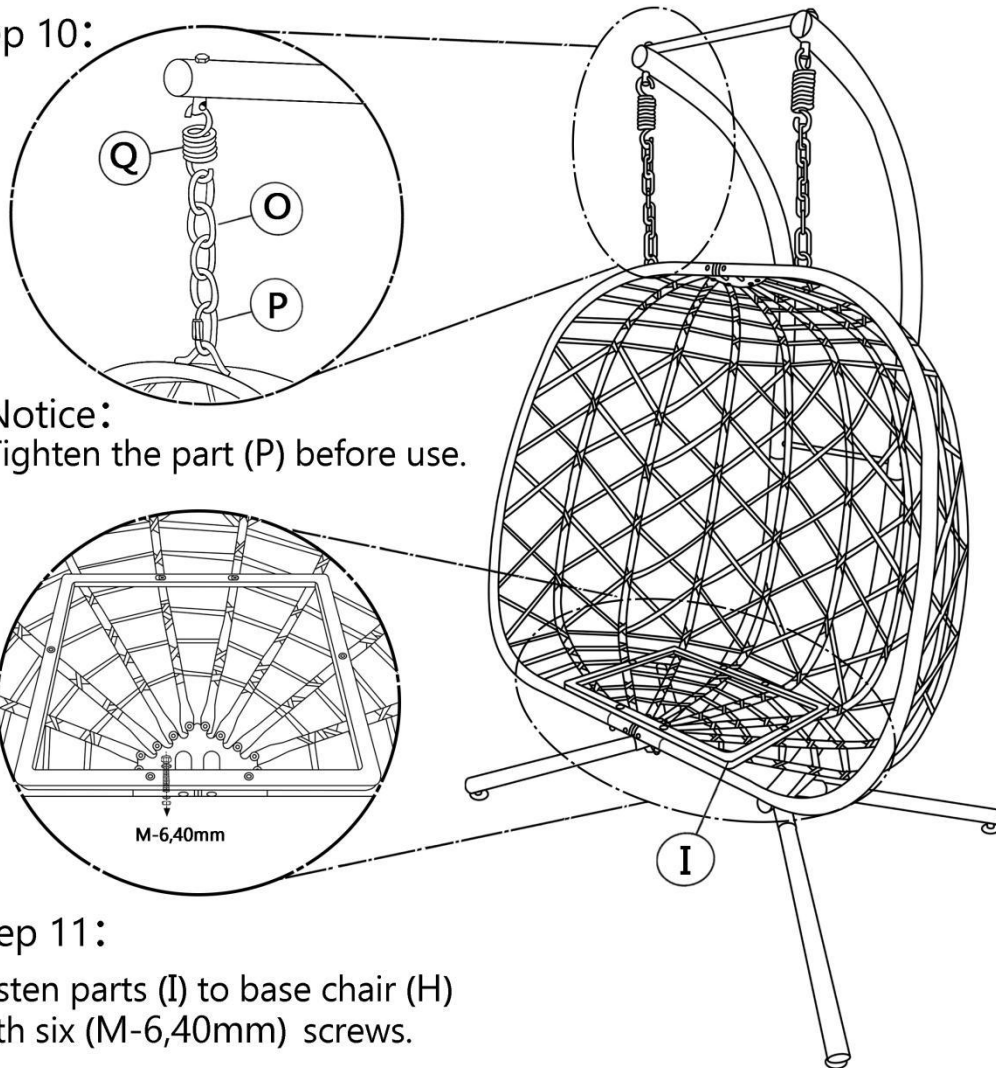

Notice:
Tighten the part (P) before use.

Step 11:

Fasten parts (I) to base chair (H)
with six (M-6,40mm) screws.

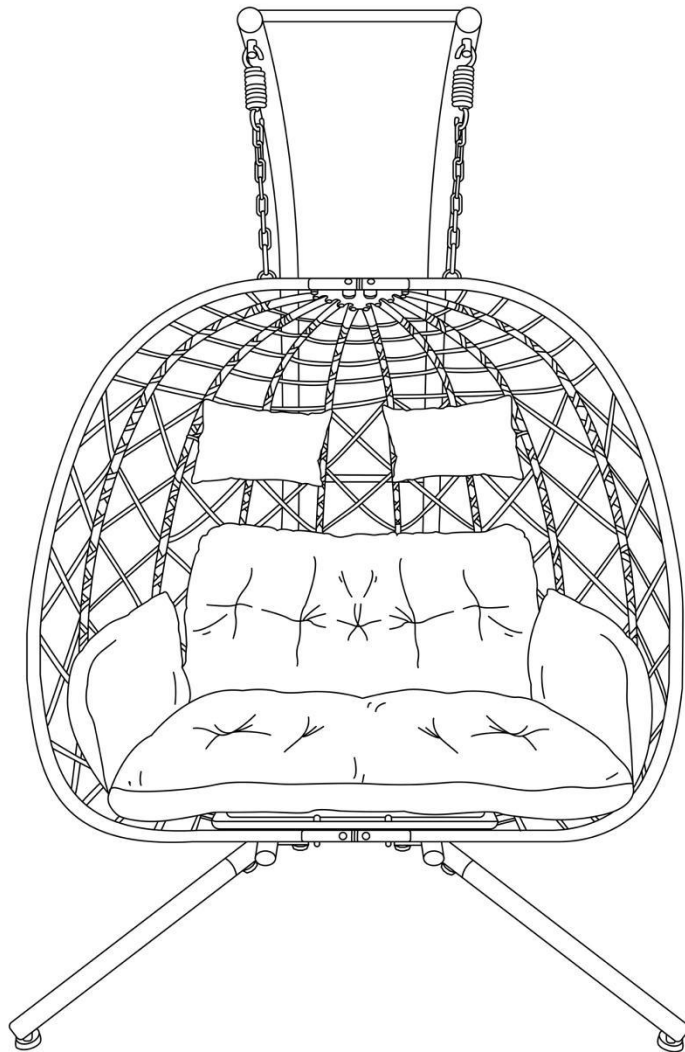

DOUBLE EGG SWING CHAIR

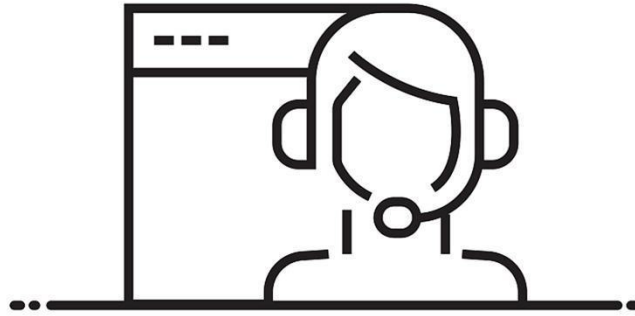

ONLINE SUPPORT

Please read the installation guide carefully before installation
If you have any questions during the installation process
you can contact us and we will provide you a detailed guidance