



**Stay fresh, Stay cool**  
[calefort.com](http://calefort.com)

**Ca'Lefort**

**Cif-WS15**



# Stay fresh, Stay cool

## Who are we?

Welcome to Ca'Lefort, where we bring you the finest collection of high-end wine and beverage coolers.

At Ca'Lefort, we are not just selling products; we are creating a lifestyle. Our journey began with a passionate pursuit of the good life.

We believe that every moment deserves to be savored in the best way possible. Every detail of our fridges is meticulously crafted to provide an exquisite storage and cooling experience.

"Stay Fresh, Stay Cool" is our slogan, embodying our core values. It encapsulates our promise to offer optimal storage solutions, ensuring your drinks remain fresh and cool. Whether you're celebrating special moments or enjoying everyday life, Ca'Lefort will be your perfect companion, adding a touch of sophistication to your lifestyle.

Experience Ca'Lefort, where impeccable design, unrivaled quality and the pursuit of perfection come together to define a truly exceptional brand.

# Product



**Cif-WS15**



**Cif-WD15**



**Cif-BS15**



**Cif-WS24**



**Cif-WD24**



**Cif-BS24**



**Cif-WF24**



**Cif-WF30**



# Ca'Lefort Wine Cooler

## Product Technical Illustration

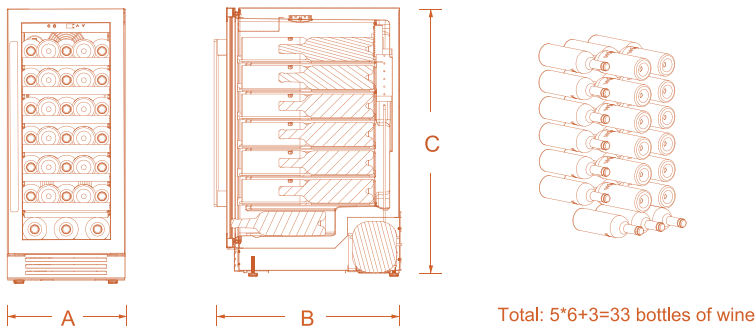

Overall Width (in.) A 14.8"

Overall Depth (in.) B 22.4" (24.1" with handle installed)

Overall Height (in.) C 34.0"

## Key Features

### Spacious Space

It's large enough to store all your favorite wine in place. 6 removable shelves allow for storing different-sized bottles.

### Advanced Cooling System

Thanks to the upgraded compressor and fan, this wine cooler chills down quickly and holds ideal temperature (40°F-65°F) stability.

### Freestanding and Built in installation

The front venting design allows this wine fridge to slide under counter or stand alone.

### Double Tempered Glass Door

Double-layer tempered glass door has maximum heat insulation, keeping a stable temperature.



# Ca'Lefort

## Unit Specifications

Width 14.8"  
Depth 22.4"  
Height 34.0"

## More Easy-To-Use Features

- 33 Wine Bottles Storage Capacity
- Advanced Cooling System Wine Cooler
- Wine Cooler Wine Cooler With Inside Digital Temperature Control
- Easy-to-Use Touch Control Panel
- 3-Color LED Lights (White, Blue, and Amber)
- Reversible Hidden Hinges Wine Cooler

## Power Requirements

Voltage:115V/60Hz  
Rated Current: 0.9A

## General Appliance Information

Please read all installation details and instructions before use.

## Note

Before connecting the wine fridge to the power source for the first time, please keep it upright at least 24-36 hours. It will reduce the possibility of a malfunction in the cooling system from handling during transportation. It is suggested to put the wine fridge in a cool and ventilated place, which will greatly improve the cooling performance.

## Contact us

Please feel free to reach out by email (service@calefortstore.com).

## Cif- WS15



# TABLE OF CONTENTS

<b>IMPORTANT SAFETY RULES</b> .....	01
<b>PARTS &amp; TECHNICAL DATA</b> .....	04
<b>INSTALLATION INSTRUCTIONS</b> .....	05
Before You Start	
How to Install (Built-in & Freestanding)	
Electrical Connection	
Install the Handel	
Install the Reversible Door	
<b>OPERATING YOUR BEVERAGE REFRIGERATOR</b> .....	09
Set the Temperature	
Clean the Refrigerator	
<b>TROUBLESHOOTING GUIDE</b> .....	12
<b>LIMITED WARRANTY</b> .....	16
<b>RECORD KEEPING</b> .....	17





# IMPORTANT SAFETY RULES

Before the appliance is used, it must be properly positioned and installed as described in this manual, so read the manual carefully. To reduce the risk of fire, electrical shock or injury when using the appliance, please follow basic precaution, including the following:

Plug into a grounded 3-prong outlet, do not remove grounding prong, do not use an adapter, and do not use an extension cord.

Replace all panels before operating.

It is recommended that a separate circuit, serving only your appliance be provided. Use receptacles that cannot be turned off by a switch or pull chain.

Never clean appliance parts with flammable fluids. These fumes can create a fire hazard or explosion. And do not store or use gasoline or other flammable vapors and liquids in the vicinity of this or any other appliance. The fumes can create a fire hazard or explosion.

## ☆ WARNING

Use two or more people to move and install appliances. Failure to do so can result in a back or other injury.

To ensure proper ventilation for your appliance, the front of the unit must be completely unobstructed. Choose a well-ventilated area with temperatures above 60°F (16°C) and below 90°F (32°C). This unit must be installed in an area protected from the elements, such as wind, rain, water spray, or drips.

The appliance should not be located next to ovens, grills, or other sources of high heat. The appliance must be installed with all electrical, water, and drain connections in accordance with state and local codes. A standard electrical supply (115 V AC only, 60 Hz), properly grounded in accordance with the National Electrical Code and local codes and ordinances, is required.

Before proceeding with cleaning and maintenance operations, make sure the power line of the unit is disconnected.

Do not connect or disconnect the electric plug when your hands are wet.

Unplug the appliance or disconnect power before cleaning or servicing. Failure to do so can result in electrical shock or death.

Do not attempt to repair or replace any part of your appliance unless it is specifically recommended in this material. All other servicing should be referred to a qualified technician.

Do not kink or pinch the power supply cord of the appliance.

The fuse (or circuit breaker) size should be 15 amperes.

It is important for the appliance to be leveled in order to work properly. You may need to make several adjustments to level it.

Never allow children to operate, play with, or crawl inside the appliance.

Do not use solvent-based cleaning agents or abrasives on the interior. These cleaners may damage or discolor the interior.

Do not use this apparatus for anything other than its intended purpose.

## FLAMMABLE REFRIGERANT GAS

**For your safety, observe the following recommendations.**

This appliance contains a small quantity of R600a refrigerant, which is environmentally friendly but flammable. It does not damage the ozone layer, nor does it increase the greenhouse effect.

During transportation and installation, ensure that the tubing of the refrigerant circuit is not damaged.

Avoid using or manipulating sharp objects near the appliances.

Leaking refrigerant can ignite and damage the eyes.

In the event that any damage does occur, avoid exposure to open fires and any device that creates a spark. Disconnect the appliance from the main power.

Thoroughly ventilate the room in which the appliance is located for several minutes. Notify Customer Service for necessary action and advice.

The room for installing the appliance must be at least 1 cubic meter per 8 grams of refrigerant. The refrigerant quantity contained in this appliance is listed above in grams; it is also noted on the rating plate of the appliance.

### ☆ DANGER

Risk of fire or explosion. Flammable refrigerant is used.

Do not use mechanical devices to defrost the refrigerator. Do not puncture refrigerant tubing.

Risk of fire or explosion. Flammable refrigerant is used. To be repaired only by trained service personnel. Do not puncture refrigerant tubing.

### ☆ WARNING

Risk of fire or explosion: flammable refrigerant used. Consult the repair manual or owner's guide before attempting to service this product. All safety precautions must be followed.

Risk of fire or explosion: dispose of property in accordance with federal or local regulations.

Risk of fire or explosion due to puncturing of the refrigerant tubing. Follow the handling instructions carefully.

# IMPORTANT SAFETY RULES

To reduce the risk of fire, electrical shock, or injury when using your appliance, follow these basic precautions:

## ☆ WARNING

Child entrapment and suffocation are problems of the past. Junked or abandoned appliances are still dangerous.

Before you throw away your old wine cellar, take off the door but leave the shelves in place so that children cannot easily climb inside.

Never allow children to operate, play with, or crawl inside the appliance.

Never clean appliance parts with flammable fluids. The fumes can create a fire hazard or explosion.

Do not store or use gasoline or any other flammable vapors or liquids in the vicinity of this or any other appliance. The fumes can create a fire hazard or explosion.

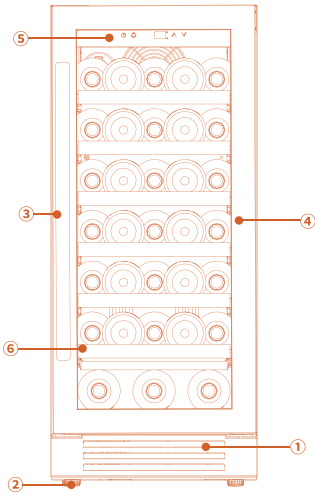

- ① **Base Grille**
- ② **Leveling Legs**
- ③ **Aluminum Alloy Handle**
- ④ **Double Tempered Glass Door**
- ⑤ **Display and Control panel**
- ⑥ **Movable Sapele Wooden Shelves (Total 6)**

## Technical Data:

Voltage:	115V/60Hz
Rated Current:	0.9A
Capacity :	28 standard 750ml wine bottles
Temperature Range:	40°F-65°F (5°C-18°C)
Net Weight:	68.2 LB
Gross Weight:	85.4 LB
Unit Dimension:	14.8"W x 22.4"D x 34.0"H
Packaging Dimension:	18.1"W x 25.6"D x 36.6"H
Refrigerant:	R600a

# INSTALLATION INSTRUCTIONS

## Before Using the Wine Cooler

Remove the exterior and interior packing

Check to be sure you have all of the following parts:

- 6\* Movable Sapele Wooden Shelves
- 1\* Aluminum Alloy Handle
- 1\* Instruction Manual
- 1\* L-Shaped Screwdriver

Before connecting the Wine Cooler to the power source, let it stand up right for approximately 24~36 hours. It will reduce the possibility of a malfunction in the cooling system from handling during transportation.

Clean the interior surface with lukewarm water using a soft cloth.

Install the handle on the left side of the door.

## Installation of the Wine Cooler

This appliance is designed to be for freestanding installation or built-in (Fully recessed). Place your product on a floor that is strong enough to support it when it is fully loaded. To level the product, adjust the front leveling legs at the bottom of the unit.

Please locate the product away from direct sunlight and sources of heat (stove, heater, radiator etc). Due to direct sunlight may affect the acrylic coating and heat sources may increase electrical consumption. Extreme cold ambient temperatures may also cause the unit not to perform properly. Don't install in a location where the temperature will fall below 60°F(16°C). Avoid locating the unit in a moist area.

For best performance, it is recommended that you install the appliance in a location with an ambient temperature between 72-78°F. If the ambient temperature is above or below recommended temperatures, the performance of the unit may be affected.

## Built-in Cabinet Instructions

For built-in installation, leave a ¼" (6 mm) space on each side and at the top of the wine cellar to ensure proper air circulation to cool the compressor and condenser. Also, be sure to not obstruct the front exhaust vent with any objects as this may affect the unit from performing properly.

## Cabinet opening dimensions

- Minimum Width: 15.05" (38.3 cm)
- Minimum Depth: 22.65" (57.6 cm)
- Minimum Height: 34.25" (87 cm)

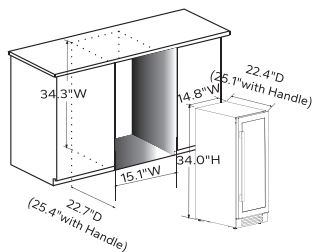

## Electrical Connection

---

### ☆ WARNING

Improper use of the grounded plug can result in the risk of electrical shock. If the power cord is damaged, have it replaced by an authorized service center.

This appliance should be properly grounded for your safety. The power cord of this appliance is equipped with a three-prong plug which mates with standard three prong wall outlets to minimize the possibility of electrical shock.

### ☆ NOTE

Plug the unit into an exclusive, properly installed, grounded wall outlet. Do not, under any circumstances, cut or remove the third (ground) prong from the power cord. For personal safety, this appliance must be properly grounded. And any questions concerning power and/or grounding should be directed toward a certified electrician or an authorized service center.

The appliance should always be plugged into its own individual electrical outlet, which has a voltage rating that matches the label on the appliance. This provides the best performance and also prevents overloading house wiring circuits that could cause a fire hazard if overheated. Never unplug the appliance by pulling the power cord. Always grip the plug firmly and pull it straight out of the receptacle. Repair or replace immediately all power cords that have become frayed or otherwise damaged. Do not use a cord that shows cracks or abrasion damage along its length or at either end. When moving the appliance, be careful not to damage the power cord.

This appliance requires a standard 115/120 volt AC/60 Hz electrical ground outlet with three prongs. Have the wall outlet and circuit checked by a qualified electrician to make sure the outlet is properly grounded. When a standard 2-prong wall outlet is encountered, it is your responsibility and obligation to have it replaced with a properly grounded 3-prong wall outlet. The cord should be secured behind the appliance and not left exposed or dangling to prevent accidental injury.

## Power bar with Surge Protection (Recommended)

---

Most electrical appliances use a series of electric control boards to operate. These boards are very susceptible to power surges and could be damaged or destroyed.

If the appliance is going to be used in an area or if your city / country is prone to power surges / outages; it is suggested that you use a power surge protector for all electrical devices / appliances you use. The surge protector that you select must have a surge block high enough to protect the appliance it is connected to.

If you have any questions regarding the type and size of surge protector, you need to contact a licensed electrician in your area.

# INSTALLATION INSTRUCTIONS

## Extension Cord

Because of potential safety hazards under certain conditions, it is strongly recommended that you do not use an extension cord with this appliance. However, if you must use an extension cord it is absolutely necessary that it be a UL/CUL-Listed, 3-wire grounding type appliance extension cord having a grounding type plug and outlet and that the electrical rating of the cord be 115 volts and at least 10 amperes.

## Installing the Handle

This wine cellar includes a Aluminum Alloy Handle. To install the handle please follow the below instructions:

**Step 1:** Remove the door gasket where the handle should be installed on the left side of the door, as shown below. You won't need tool since the gasket can be removed by hand. You can start with a corner if you can't remove it from the center.

**Step 2:** Use the two handle screws, lock washer and flat washer included in the bag containing the instruction manual and insert them into the side of the door from

**Step 3:** Align the holes in the handle with the screws, tighten the screws using the screwdriver until the base of the handle is at the level of the door and that the handle is tight but not too tight to damage the assembly.

**Step 4:** Replace the gasket the door in place.

**Note:** The Handle Screws ④ are packed with other accessories in the instruction manual bag please insert them into the door before installing the handle.

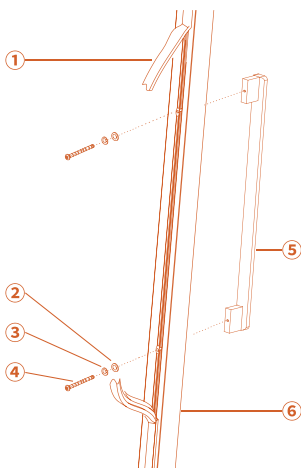

- ① Gasket
- ② Flat washer
- ③ Lock washer
- ④ Screw
- ⑤ Handle
- ⑥ Door frame

## Installing Reversing the Door

1. Please remove the bottom hinge holder ② by unscrewing the two lock screws. Be careful to hold the glass door firmly after removing the screws. **Please check Figure 1**
2. Gently pull down to remove the glassdoor from the right top hinge and place it on a padded surface to avoid the risk of damage
3. Using a flat-head screwdriver, gently pry up the decorative hinge cover plate on the top left of the unit and the round black decorative cover caps on the upper leftside corner of the inside cabinet frame Use them to cover the screw holes on the right-hand side.
4. Move the top hinge from the right-hand side to and use the upper right hinge that is equipped along with the manual in the cabinet to install on the left side of cabinet by removing the screws ⑦. **Please check Figure 3/4**
5. Relocate the door to the left-hand side of cabinet by placing the door hinge holes into the hinge, then screw the bottom hinge assembly with the lower hinge fixer ④ onto the left designated position and tighten after the door is eveled. **Please check Figure 4**

Figure 1

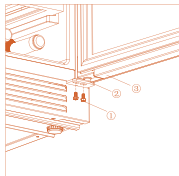

Figure 2

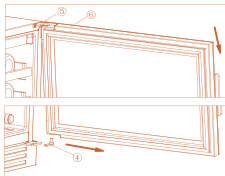

Figure 3

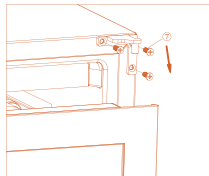
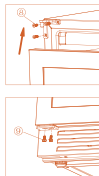

Figure 4



# OPERATING YOUR WINE COOLER

It is recommended you install the wine cooler in a place where the ambient temperature is between 66°F-75°F (19°C-24°C). If the ambient temperature is above or below recommended temperatures. The performance of the unit may be affected. For example, placing your unit in extreme cold or hot conditions may cause interior temperatures to fluctuate. The range of 40°F-65 (5°C-18°C) may not be reached.

## Control Panel



### ON/OFF:

Press and hold the ON / OFF control button for 5 seconds will shut down the appliance but still power on, only the on/off icon will light up.

### INSIDE LIGHTING:

The cooling zone has an interior light. Press once the light control button will switch between different colors and off, the light color switch cycle sequence is in white, blue, amber color and off.

### TEMPERATURE DISPLAY:

To change the temperature display from Fahrenheit to Celsius, press and hold the light button for five seconds.

 **[+] BUTTON:** To increase the temperature by 1°C or 1°F

 **[-] BUTTON:** To decrease the temperature by 1°C or 1°F

### Control panel:

5 minutes without any operation, all the touch keypad light will turn off and the temperature will display normally. Touch any keypad can light up the button indicating light.

## NOTE

If the unit is unplugged, if the power is lost, or turned off, you must wait 3 to 5 minutes before restarting the unit. If you attempt to restart before this time delay, the wine cooler will not start.

When you use the wine cooler for the first time or restart the wine cooler after having been shut off for a long time, there could be a few degrees variance between the temperature you select and the one indicated on the LED readout. This is normal and it is due to the length of the activation time. Once the wine cooler is running for a few hours everything will be back to normal.

## Setting the Temperature

The temperature range of wine cooler ( Clf-WS15 ) is 40°F-65°F (5°C-18°C). The temperature will increase by 1°C or 1°F if you touch UP once, or the temperature will decrease by 1°C or 1°F if you touch DOWN once. To view the setting temperature at any time, touch the UP or DOWN marks. The setting temperature will temporarily flash in the LED display for 5 seconds and show the set temperature in white.

### ☆ NOTE

This product is designed for storing and cooling wine. It is not intended for storage of perishable foods.

## Large Storage Capacity

While bottles may vary in size and dimension, approximately 33 traditional Bordeaux 750ml bottles can be stored in the wine cooler. You can place 5 bottles on each shelf and 3 standard bottles in the bottom of the cabinet.

### ☆ NOTE

Wine bottles on bottom shelf cannot be longer than 12 inches.

**Total: 5 bottles**



**About total 33 bottles.**

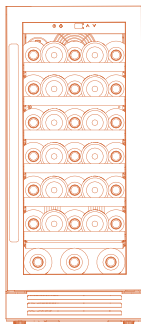

## POSSIBLE CAUSE

Wine Conservation	°C	°F
sparkling wines	5-8	40-47
Rose wines	10-11	49-51
Dry/white wines	9-14	48-57
Red wines	15-22	58-72

## Moving the Wine Refrigerator

1. Remove all items (bottles)
2. Tape down securely all loose items (shelves) inside your appliance.
3. Turn the adjustable leg up to the base to avoid damage.
4. Tape the door shut
5. Be sure the appliance stays secure in the upright position during transportation. If you absolutely need to transport the cellar horizontally, transport the cellar on its back (door on top).
6. Protect outside of appliance with a blanket, or similar item.

# OPERATING YOUR WINE COOLER

## Cleaning the Wine Cooler

Turn off the power, unplug the appliance, and remove all items including shelves. Wash the inside surfaces with a warm water and baking soda solution. The solution should be about 2 tablespoons of baking soda to 1 cup of water. Wash the shelves with a mild detergent solution. Wring excess water out of the sponge or cloth when cleaning area of the controls, or any electrical parts. Wash the outside cabinet with warm water and mild liquid detergent. Rinse well and wipe dry with a clean soft cloth.

### ☆ ATTENTION

Please do not disconnect the unit during operation to avoid you exposing yourself to risk of electric shock or personal injury.

## Charcoal Filtration System

Your wine refrigerator is equipped with an active charcoal filtration system to ensure air purity and to maintain an odour free cabinet for the storage of your wines. The filter is located at the bottom of the rear panel inside your cellar. Keep in mind, that this filter should be changed every 12 months.

Remove the bottles of wine stored on the two shelves in front of the filter.

Remove the shelves and set aside to be replaced once you have changed the filter

Hold the filter and turn it at 45 degrees in the counter-clockwise direction and then pull it out.

Remove the existing filter and replace with a new one.

Put the new filter into the hole and then turn the filter at 45 degrees in clockwise direction.

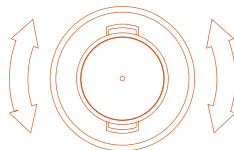

## Automatic Defrosting

The unit defrost automatically. The evaporator behind the rear wall of the unit defrosts automatically. The condensate collects in the drainage channel behind the rear wall of the unit, and flows through the drainage hole into the drip tray by the compressor where it evaporates.

## Power Failure

Most power failures are corrected within a few hours and should not affect the temperature of your appliance if you minimize the number of times the door is opened. If the power is going to be off for a longer period of time, you need to take the proper steps to protect your contents.

## Energy Saving Tips

The wine refrigerator should be located in the coolest area of the room, away from heat producing appliances, and out of the direct sunlight. Ensure that the unit has proper allowances on all sides for proper ventilation. Never cover any air vents.

Only open the cooler door for as long as necessary. Frequent opening of the door will affect internal temperature.

# TROUBLESHOOTING GUIDE

You can solve many common wine cellar problems easily, saving you the cost of a possible service call. Please try the suggestions below to see if you can solve the problem before emailing the service team.

PROBLEM	POSSIBLE CAUSE	SOLUTION
Cellar does not operate	Not plugged in. The appliance is turned off. The circuit breaker tripped or a blown fuse.	Plug the unit. Turn on the unit. Check the breaker and/or fuses.
The compressor turns on and off frequently	The room temperature is hotter than normal. A large amount of contents has been added to the cellar. The door is opened too often. The door is not closed completely. The temperature control is not set correctly. The door gasket does not seal properly.	Close the door properly. Check the door gasket. Don't open or close doors frequently
The fans turn on and off frequently	In order to circulate the air and maintain the set temperature inside the cabinet the fans must cycle on and off even when the compressor is off. The fans will cycle ON and OFF while the compressor is off approximately every 20 seconds, this is called [Semi-speed status] . This cycle is normal and meant both to circulate the air as well as ensure the continued operational status of the fans. If the fan stops completely and does not complete this cycle the fan is non-operational.	
Fan is always running	This is simply a function of the cooling system. The lower the setting the more the fan will run. If the room is very warm, the cooler will run more. The unit has been designed to run continuously when operating at the lower temperatures.	
The light does not work	Not plugged in. The circuit breaker tripped or a blown fuse. The light button is "OFF".	
The light does not work.	Not plugged in. The circuit breaker tripped or a blown fuse. The light button is "OFF".	Plug the unit. Press the power button turn on the Cellar. Check the breaker and/or fuses.

# TROUBLESHOOTING GUIDE

PROBLEM	POSSIBLE CAUSE	SOLUTION
Vibrations sound	The cellar does not be leveled The bottles are vibrating. There is an object under the Cellar.	Check to ensure that the Cellar is level. Make sure the bottles don't touch each others. Remove the object. Add silicone pads.
Cellar is not cold enough	The temperature has not been set to a low temperature value. The door is not completely closed. The door seal is deformed or damaged. The door opens too frequently.	Check the temperature control setting. Close the door properly. Check the door gasket. Don't open or close doors frequently
The phenomenon of flashing lights	In some instances, this is normal the light may flash when the automatic defrost function starts to work. Set temperature is higher than inner temperature.	Adjust temperature to resolve.
Frost appears in cabinet (on back)	Either too much humidity or too low of temperature inside cabinet.	Unplug cellar and allow to manually defrost. Reconnect when ice has melted. If problem persists, please contact service center for assistance.
The door will not close properly	The Cellar is not level, The door was reversed and not properly installed. The gasket is deformed or damaged. The shelves are out of position.	Level the cellar. Close the door properly. Clean the door gasket or Place the shelves properly.
Not cooling	Compressor and fan not working. The temperature is not set properly. Damaged door control switch. Pipeline blockage and solenoid valve malfunction. Leakage of refrigerant.	Open and close the door several times, listen to whether the compressor and fan are working properly? If working normally, is the set temperature value normal? If it is still normal, then confirm whether the sealing strip of the door seam is damaged, causing the door to not close tightly? If all the above issues are normal, it may be caused by a refrigeration system malfunction or refrigerant leakage. Please contact customer service center for assistance.

## PROBLEM

## POSSIBLE CAUSE

The product seems to make too much noise

The unit is not level.  
Fan noise (inner fan, outer fan).  
Working noise of refrigeration system (compressor noise).  
Vibration noise (internal and external fan vibration, compressor vibration, loose foot pads).

## SOLUTION

Level the cellar.

Check whether the inner and outer fans have scraped the wire group or other foreign objects on the blades during operation.

The rattling noise may come from the flow of the refrigerant, which is normal. As each cycle ends, you may hear gurgling sounds caused by the flow of refrigerant in your cellar. Contraction and expansion of the inside walls may cause popping and crackling noises. Check whether the inner and outer fans scrape the wires or other foreign objects during operation.

Check whether all parts inside and outside the box are tight, slippery teeth, missing, all parts should be all tight state.

Check whether the foot of the bottom of the box is high or low, if so, readjust to four feet are close to the ground.

Check whether the pipes in the compressor compartment are bumping into pipes or walls. If so, it is necessary to readjust the distance between pipes and pipes and between pipes and walls, preferably >5mm.

# TROUBLESHOOTING GUIDE

PROBLEM	POSSIBLE CAUSE	SOLUTION
Display shows: E1, E2, E5, E6, E7, E8, E9, EA, EU	Temperature sensor failure or communication error	Please call the service center.
L0	Low temperature alarm	Please call the service center.
HI	High temperature alarm	Please confirm whether the internal and external fans are operating and whether the compressor is started? Both of the above are fine, but the temperature sensing probe is faulty; If the internal fan does not turn, it is a fan malfunction. all of the above questions, please contact the customer service center.
Et	Temperature difference alarm	Please turn off the product and unplug the power supply, open the door for ventilation for 24-36 hours, and then the error can be cleared. If the problem is not solved after ventilation, you could also carefully remove the back plate of the fan inside the box to determine if there is ice formation. After the ice melts, restart the machine to set the temperature. It is recommended not to set the minimum temperature at this time.
E0	The door is not closed properly	Check if the door is not tightly closed. If it is not properly closed, close the door again.If unable to resolve the issue, please contact after-sales service.

## 1 YEAR WARRANTY PARTS & LABOUR

---

For a year (12 months) from the date of delivery by the original owner, we will, at its option, repair or replace any part of the unit, which proves to be defective in material or workmanship under normal use.

During this period we will provide all parts and labour necessary to correct such defects free of charge, so long as the unit has been installed and operated in accordance with the written instructions in this manual.

## WHAT IS NOT COVERED

---

Damage due to such things as accident, misuse, abuse, mishandling, neglect, acts of God, fires, earthquakes, floods, high winds, government, war, riot or labour troubles, strikes, lockouts, delay of carrier, or any cause beyond the control of the Seller whether similar or dissimilar to the foregoing.

Content losses due to spoilage.

Incidental or consequential damages.

Parts and labour costs for the following will not be considered as warranty:

Door springs, and/or frames.

Inner door panels, door rails and/or door supports.

Light bulbs and/or plastic housing.

Plastic cabinet liners.

Purchaser understands and acknowledges that the goods purchased are wine cellars, which house wines. Purchaser assumes all risk of using this unit, including risk of spoilage, humidity variations, temperature variations, leaks, fire, water damage, mold, mildew, dryness, and similar perils that might occur.

## 3 YEAR WARRANTY COMPRESSOR

---

For the 2nd through the 3rd year from date of original delivery, we will provide a replacement compressor free of charge due to a failure.

You are responsible for the service labour and freight charges. Cost to move the wine cellar to the servicers' shop and back to the user's home, as may be required, are the user's responsibility.

Punctured evaporator that voids the warranty on the complete sealed system.

Repairs performed by unauthorized servicers.

Service calls that do not involve defects in material or workmanship such as customer education, door reversal, or proper installation.

Service calls that are related to external problems, such as abuse, misuse, inadequate electrical power, accidents, fire, floods, or acts of God.

Replacement of house fuses or resetting circuit breakers.

Failure of the product if it is used for other than its intended purpose.

This warranty does not apply outside Canada or the Continental USA.

## Contact Us

---

Our experienced customer service team is always here to help you. If you have any questions, please contact us by the following way.

### Spacious Space

[service@mycalefort.com](mailto:service@mycalefort.com)

<b>Address</b>	
<b>Phone</b>	
<b>Fax</b>	
<b>Email</b>	
<b>Online</b>	



