

***GRANDFATHER
CLOCK***

INSTRUCTIONS

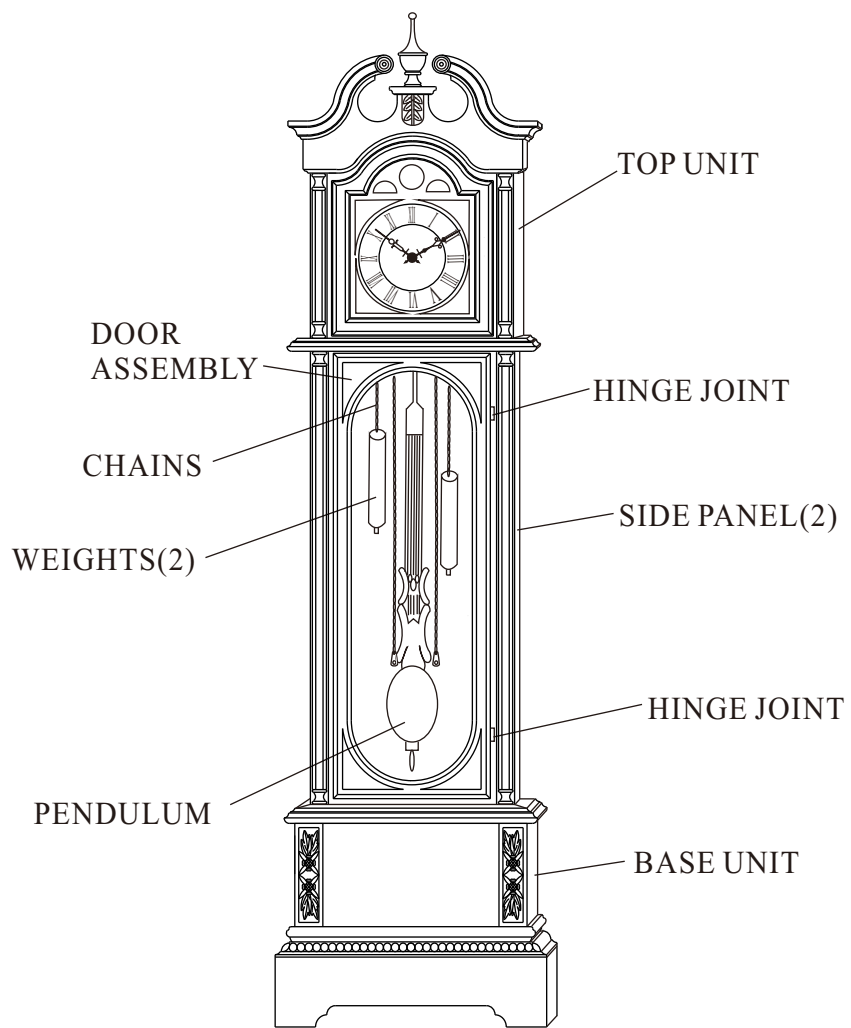

Congratulations! You are now the proud owner of a fine timepiece. It has been carefully designed and crafted to give you years of dependable operation. Read this booklet thoroughly before assembling and operating your clock in order to become familiar with its many features, thereby assuring you proper performance and continued enjoyment. Keep these instructions in a safe place for future reference.

ATTENTION:

In order to insure that your clock is stable adjust the levelers at the bottom of the clock. As an added safety feature a support strap has been provided that is fixed to the top of the clock and must be attached to the wall. **It is recommended that you do so.**

HOW TO ASSEMBLE YOUR CLOCK CABINET

1. Carefully unpack all parts and compare each item to the following list to be sure you have everything required.

QTY :DESCRIPTION

- 1 Top Finial
- 1 Base Unit
- 2 Side Panels.(right side panel hinge)
- 1 Top Unit with Door, Dial and Movement
- 1 Back Panel
- 1 Front Door with Glass(hinges on right)

- 1 Pendulum with Brass Bob
- 8 Machine Screws(phillips head)
- 8 Washers
- 2 Weights
- 2 Hinge joints(Rods)

2. Place the BASE UNIT near its final position but leave it away from the wall until the assembly is finished.

3. Fit SIDE PANEL without hinges into the grooves in the base unit on the left side of the clock and attach it from the inside with two of the MACHINE SCREWS(Figure A) using a Phillips head screwdriver. Repeat the process using the Side Panel with the hinges on the right side of the clock.
4. Fit the BACK PANEL into the grooves in the Side Panels at the back of the cabinet and the Bottom Unit (Figure B).
5. Slip the pre-hinged front door into place by lowering it over the matching hinge on the RIGHT SIDE PANEL (Figure C). Take your time lining up both parts slowly and it will drop into position.

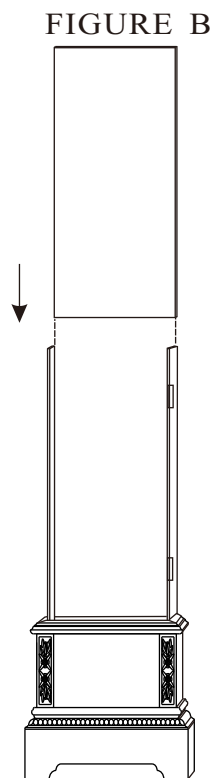
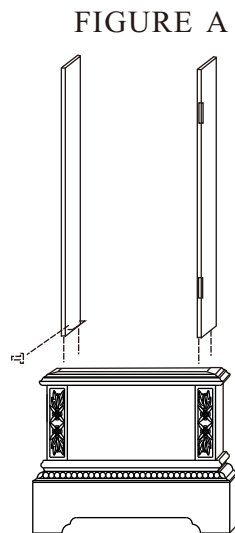

6. Carefully fit the TOP UNIT down onto the SIDE PANELS. Be sure to keep the side panels straight while working (Figure D). Attach the TOP UNIT with the four remaining MACHINE SCREWS in the same manner as the Side Panels.

NOTE: At this point the cabinet is ASSEMBLED.

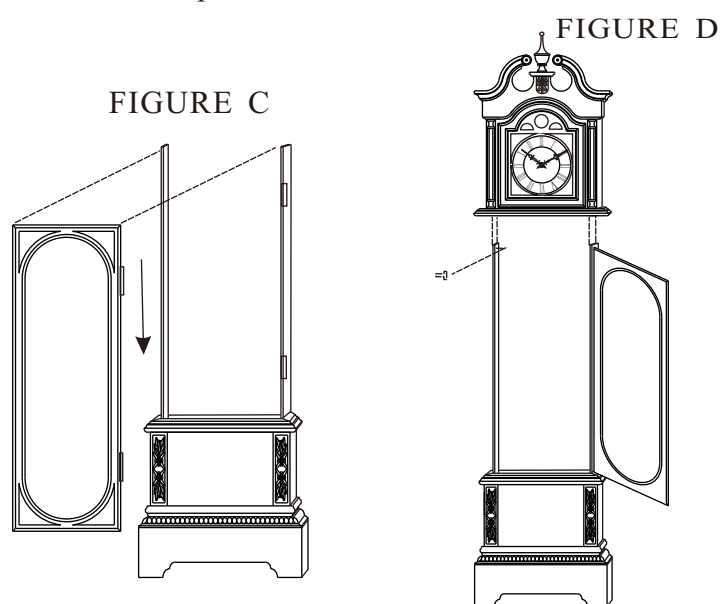

7. How to hook the weights:

Hook the WEIGHTS on the end of the CHAINS located on the bottom inside edge of the TOP UNIT.

NOTE: The Weights are the only decorative and can be located any way you like except directly in front of the PENDULUM BOB (this would interfere with the swing of the Pendulum).

8. The clock can be aligned and made vertical through adjusting four leveling feet at the bottom.

TIME AND CHIME SETTING:

CONGRATULATIONS-You have purchased a quality clock which plays the Westminster chime melody on the hour, tolls the hour and has an automatic shut-off(clock does not chime between 10.00 p.m. and 6.00a.m.).To ensure that your clock functions correctly, please follow the time and chime setting instructions precisely, The clock will chime during the day and will automatically turn off at night.

1.Pull upwards the back panel of the Top Unit.

2.BEFORE inserting batteries set the clock at 6.05AM(5 minutes past 6)with knob A.

3.Insert 1 x AA Alkaline battery into the clock battery chamber, according to the positive (+) and negative (-) symbols.

4.Insert 2 x AA Alkaline batteries into chime battery chamber, according to the positive(+) and negative(-)symbols. Make sure batteries are secure in the holder. The clock will chime automatically and toll 6 times.

5.Now turn hands (using knob A) slowly to the present hour (in a clockwise direction).Remember that the clock started at 6:05 in the morning, If setting at night, lets say, to 9:20PM,then hands will be turned thus-7,8, 9, 10, 11, 12, 1, 2, 3, 4, 5, 6, 7, 8,9then9:20. The last strike you hear will be 9 times.

N.B. When moving hands to the present time clock will begin chiming. Do not be concerned about this. The last strike you hear after setting the clock at appointed time will be the correct one.

6.When replacing batteries remember that all the above must be repeated from point one , i.e. the clock must be started again at 6.05a.m.Therefore,please do not throw these instructions away as by the time the batteries have to be replaced; you may have forgotten how to set the clock.

7. To eliminate chimes, remove the two batteries from the Chime Battery Chamber.

8. Never turn clock hands counter clockwise as it will interrupt the chime sequence and damage the clock.

N.B.: WHEN BATTERIES ARE LOW, CHIMES WILL NOT REMAIN CO-ORDINATED WITH THE TIME ON THE CLOCK. WHEN THIS HAPPENS, REPLACE WITH NEW ALKALINE BATTERIES AND RESET CLOCK AS ABOVE.

FIGURE E

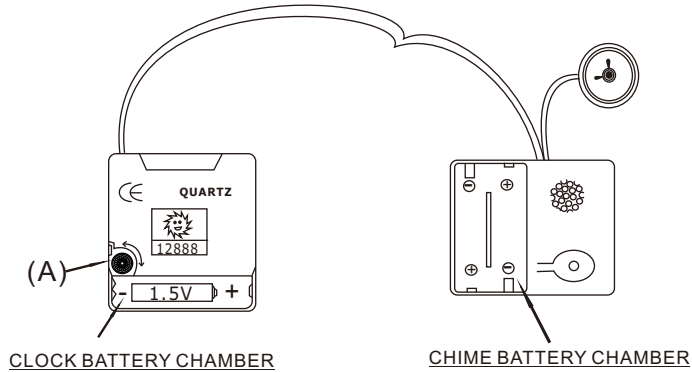

Do not mix old and new batteries. Do not mix alkaline, standard(carbon-zinc),or rechargeable (nickel-cadmium) batteries.

PENDULUM SETTING:

1. Insert 2C Alkaline batteries into the pendulum battery chamber according to the positive(+)and negative(-)symbols.
2. For transport security, the small black plastic pendulum (B) may be attached to the case(C) to prevent it from swinging.
3. At(D)using thumb pressure push towards you right to loosen the pendulum and allow it to swing freely.
4. Attach pendulum to black pendulum holder at(G). The brass side of the pendulum bob should faces the front of the clock.

(Figure G)

5. Give main Pendulum a push sideways to get it swinging.

FIGURE F

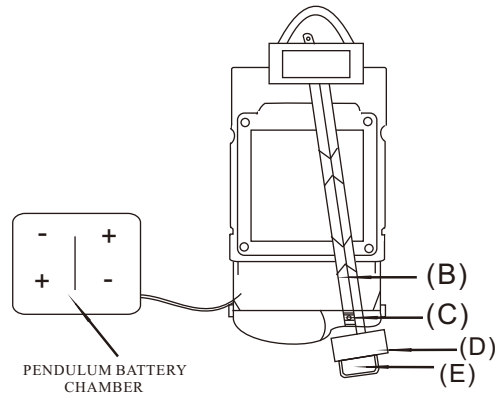

Do not mix old and new batteries. Do not mix alkaline, standard(carbon-zinc),or rechargeable (nickel-cadmium) batteries.

FIGURE G

Take off the red plastic ring before the pendulum

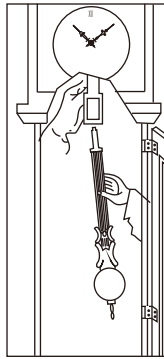

Hanging the pendulum

ATTENTION:

In order to insure that your clock is stable adjust the levelers under the clock. As an added safety feature a support strap has been provided that is fixed to the top of the clock and must be attached to the wall. It is recommended that you do so.

