

User's Manual

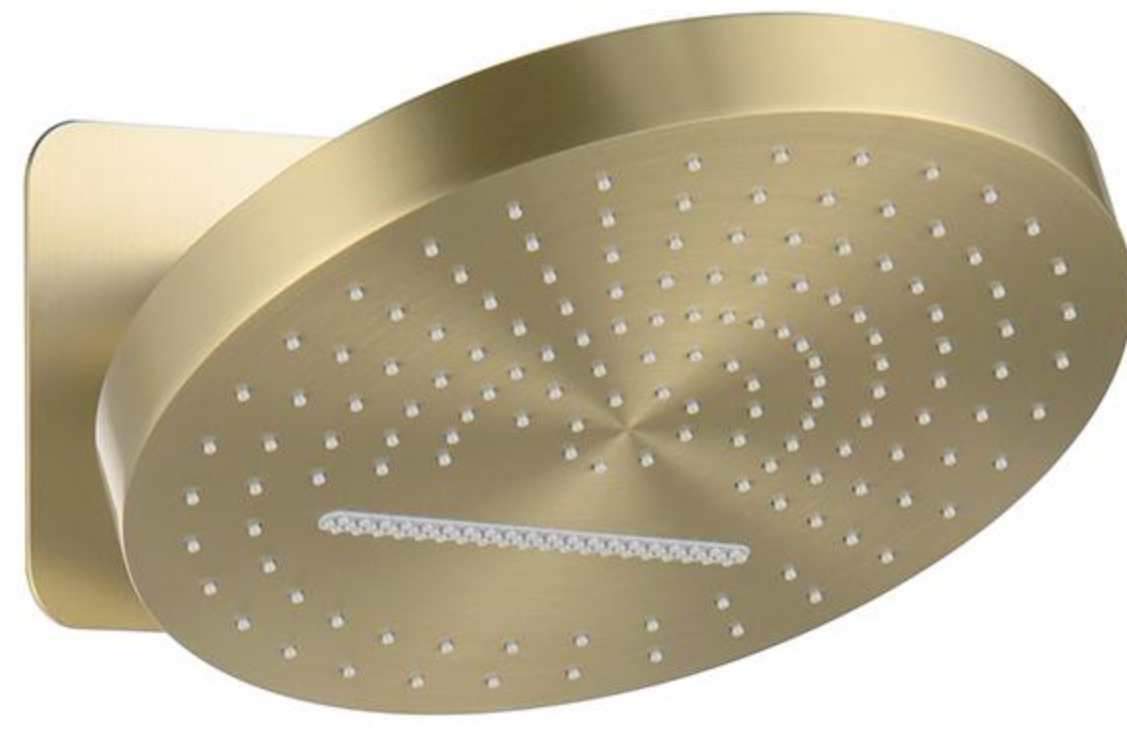

INSTALLATION INSTRUCTIONS

Installation Manual



RB1235

IAPMO RESEARCH AND TESTING, INC.
5001 East Philadelphia Street, Ontario, California 91761-2816 - USA - 909-472-4100 - 909-472-4244 - www.iapmort.org

CERTIFICATE OF LISTING

IAPMO Research and Testing, Inc. is a product certification body which tests and inspects samples taken from the supplier's stock or from the market or a combination of both to verify compliance to the requirements of applicable codes and standards. This activity is coupled with periodic surveillance of the supplier's factory and warehouses as well as the assessment of the supplier's Quality Assurance System. This listing is subject to the conditions set forth in the characteristics below and is not to be construed as any recommendation, assurance or guarantee by IAPMO Research and Testing, Inc. of the product acceptance by Authorities Having Jurisdiction.

This certificate is not evidence of current listing. To verify listing status, visit the IAPMO R&T Product Listing Directory at pld.iapmo.org

Effective Date: December 2019 -Rev. 2/24/2020- Void After: December 2024
Product: Flexible Water Connectors File No. 5311
Issued To: Fanaki Group Inc. Mechanical & Electrical Industrial Zone, Yuhuan County, Yuhuan 317600, ZHEJIANG China

Identification: Products shall be marked with manufacturer's name or trademark, a statement "For use with water in accessible locations only." The products shall also bear the cUPC® certification mark. Markings shall be by means of either a permanent mark on the product, a label on the product or a tag attached to the product.

Characteristics: Flexible water connectors manufactured in various sizes, lengths and metal end fittings for hot or cold water applications that consist of an inner tube, which may or may not have an outer braided cover. Connectors are to be installed for use in accessible locations only. To be installed in accordance with the manufacturer's instruction, and the latest edition of the Uniform Plumbing Code and National Plumbing Code of Canada.

Products listed on this certificate have been tested by an IAPMO R&T recognized laboratory. This recognition has been granted based upon the

Chairman, Product Certification Committee CEO, The IAPMO Group

This listing period is based upon the last date of the month indicated on the Effective Date and Void After Date shown above. Any change in material, manufacturing process, marking or design without having first obtained the approval of the Product Certification Committee, or any evidence of non-compliance with applicable codes and standards, or of inferior workmanship, may be deemed sufficient cause for revocation of this listing. Production of or reference to this form for advertising purposes may be made only by specific written permission of IAPMO Research and Testing, Inc. Any alteration of this certificate could be grounds for revocation of the listing. This document shall be reproduced in its entirety.

IAPMO RESEARCH AND TESTING, INC.
5001 East Philadelphia Street, Ontario, California 91761-2816 - USA - 909-472-4100 - 909-472-4244 - www.iapmort.org

CERTIFICATE OF LISTING

IAPMO Research and Testing, Inc. is a product certification body which tests and inspects samples taken from the supplier's stock or from the market or a combination of both to verify compliance to the requirements of applicable codes and standards. This activity is coupled with periodic surveillance of the supplier's factory and warehouses as well as the assessment of the supplier's Quality Assurance System. This listing is subject to the conditions set forth in the characteristics below and is not to be construed as any recommendation, assurance or guarantee by IAPMO Research and Testing, Inc. of the product acceptance by Authorities Having Jurisdiction.

This certificate is not evidence of current listing. To verify listing status, visit the IAPMO R&T Product Listing Directory at pld.iapmo.org

Effective Date: November 2019 Void After: November 2024
Product: Plumbing Fixture Fittings File No. 10633
Issued To: Aqua Gallery Co., Ltd 13th-15th A10 Block International Ceramics Sanitary City, 528000 Foshan, China

Identification: Plumbing supply fittings complying with this Standard shall be marked with the manufacturer's recognized name, trademark, or other mark or, in the case of private labeling, the name, trademark or other mark of the customer for whom the fitting was manufactured. The marking shall be accomplished by use of a permanent mark or by placing a permanent label on the product. Markings on plumbing supply fittings shall be visible after installation.

Single-handle, single-control, and automatic compensating mixing bath and shower valves shall have identifiable temperature control settings in which the settings are indicated by words ("cold", "warm", "hot", etc.), by numbers, or graphically.

Packages shall be marked with the manufacturer's name, trademark, or other mark as well as the model number or, in the case of private

Chairman, Product Certification Committee CEO, The IAPMO Group

This listing period is based upon the last date of the month indicated on the Effective Date and Void After Date shown above. Any change in material, manufacturing process, marking or design without having first obtained the approval of the Product Certification Committee, or any evidence of non-compliance with applicable codes and standards, or of inferior workmanship, may be deemed sufficient cause for revocation of this listing. Production of or reference to this form for advertising purposes may be made only by specific written permission of IAPMO Research and Testing, Inc. Any alteration of this certificate could be grounds for revocation of the listing. This document shall be reproduced in its entirety.

IAPMO RESEARCH AND TESTING, INC.
5001 East Philadelphia Street, Ontario, California 91761-2816 - USA - 909-472-4100 - 909-472-4244 - www.iapmort.org

COMPONENT CERTIFICATE OF LISTING

IAPMO Research and Testing, Inc. is a product certification body which tests and inspects samples taken from the supplier's stock or from the market or a combination of both to verify compliance to the requirements of applicable codes and standards. This activity is coupled with periodic surveillance of the supplier's factory and warehouses as well as the assessment of the supplier's Quality Assurance System. This listing is subject to the conditions set forth in the characteristics below and is not to be construed as any recommendation, assurance or guarantee by IAPMO Research and Testing, Inc. of the product acceptance by Authorities Having Jurisdiction.

This certificate is not evidence of current listing. To verify listing status, visit the IAPMO R&T Product Listing Directory at pld.iapmo.org

Effective Date: March 2019 Void After: March 2024
Product: Plumbing Fixture Fittings - Components File No. MC-9703
Issued To: Ningbo Manhai Cartridge Technology Co., Ltd. Xiaochen Zone, Chunhu Fenghua, NINGBO 315538 China

Identification: Each fitting component shall bear permanent legible markings to identify the manufacturer. This marking shall be the trade name, trademark, or other mark known to identify the manufacturer. The product shall also bear all other markings required by the standard. The marking shall be applied so as to be visible after installation. The product or packaging shall also bear the cUPC® certification mark along with the term "COMPONENT" above.

Characteristics: Plumbing fixture fitting components to be installed in accordance with the manufacturer's instructions and the requirements of the latest edition of the Uniform Plumbing Code.

Products listed on this certificate have been tested by an IAPMO R&T recognized laboratory. This recognition has been granted based upon the laboratory's compliance to the applicable requirements of ISO/IEC 17025.

Products are in compliance with the following code(s):
Uniform Plumbing Code (UPC®)

Chairman, Product Certification Committee CEO, The IAPMO Group

This listing period is based upon the last date of the month indicated on the Effective Date and Void After Date shown above. Any change in material, manufacturing process, marking or design without having first obtained the approval of the Product Certification Committee, or any evidence of non-compliance with applicable codes and standards, or of inferior workmanship, may be deemed sufficient cause for revocation of this listing. Production of or reference to this form for advertising purposes may be made only by specific written permission of IAPMO Research and Testing, Inc. Any alteration of this certificate could be grounds for revocation of the listing. This document shall be reproduced in its entirety.

INSTALLATION STEPS

This product has been inspected and debugged by the factory to the best condition. Please do not disassemble and assemble it yourself.



Before installing the faucet, please be sure to remove sundries and sludge from the water pipe to prevent sundries from blocking the faucet.

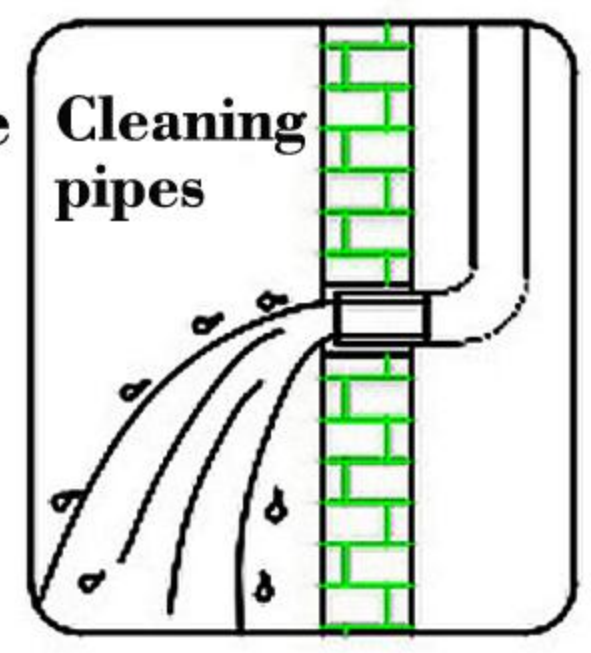

INSTALLATION PARAMETERS (FOR REFERENCE)

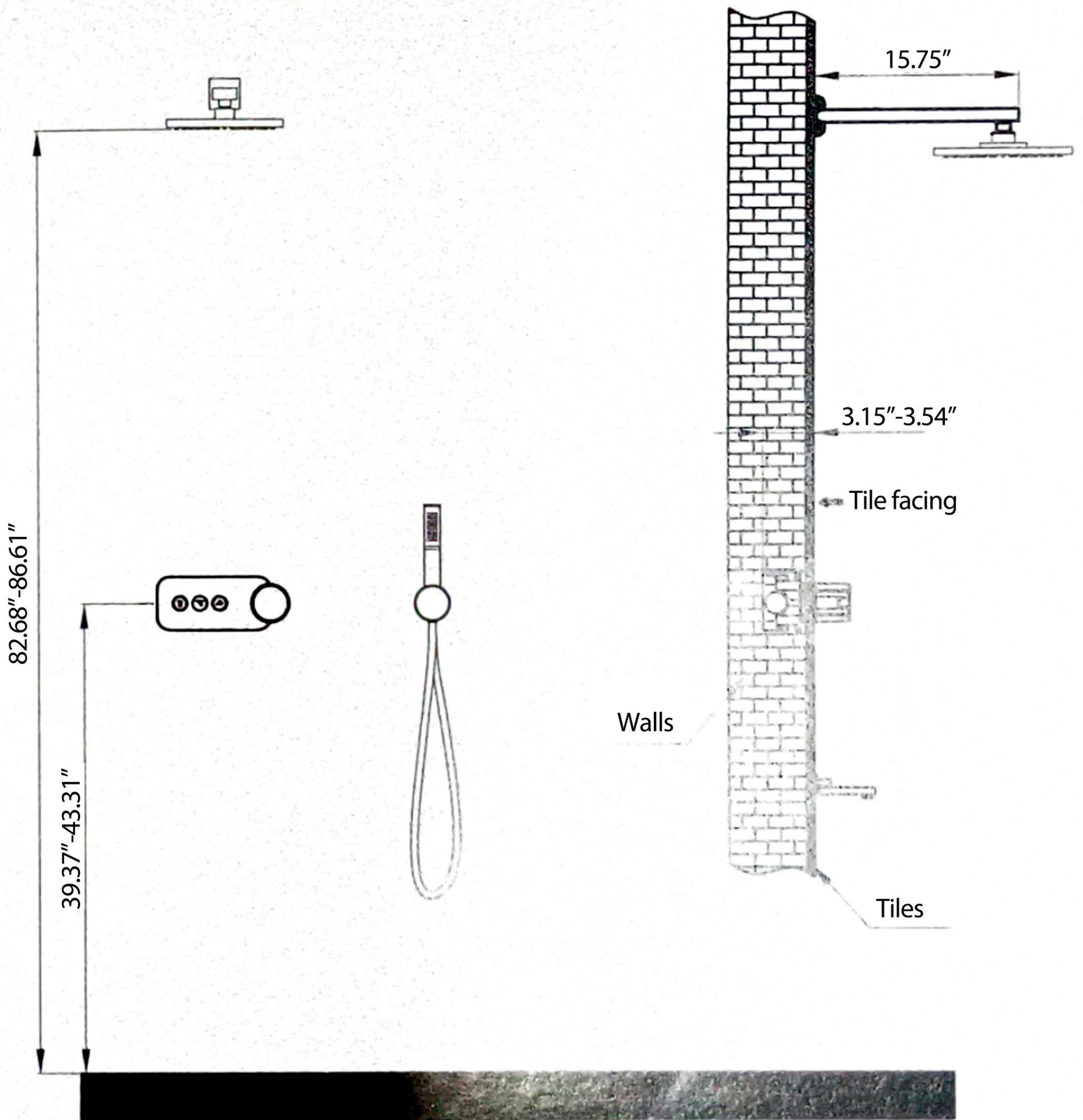

Unit: inch

MAIN OPENING DIMENSION DRAWING

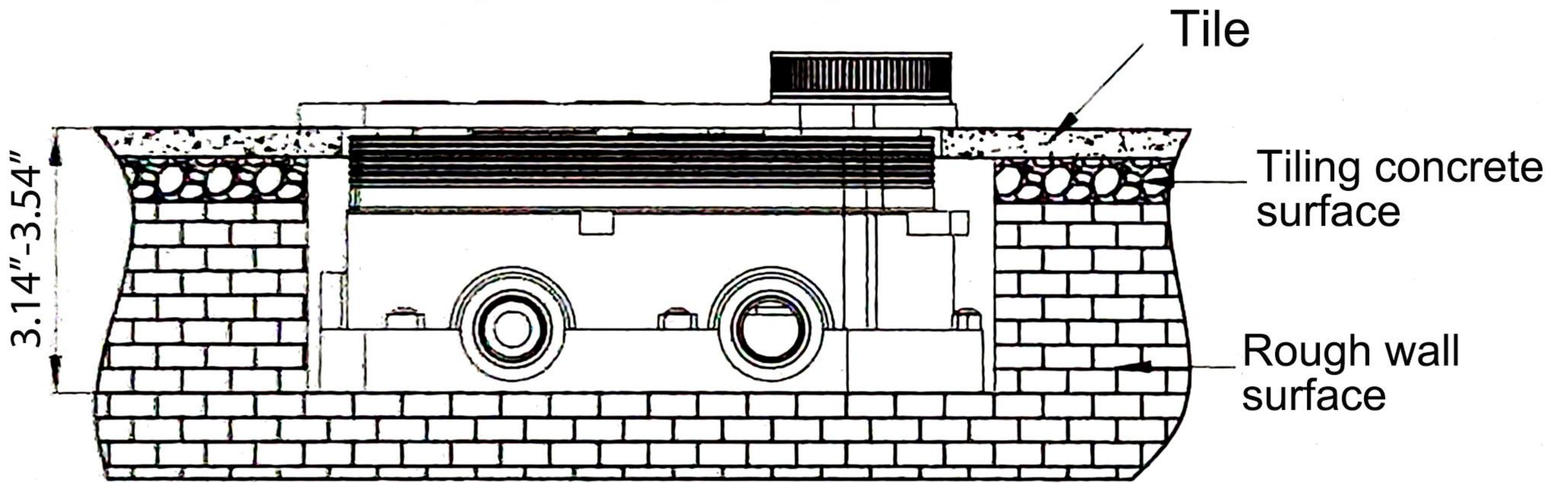
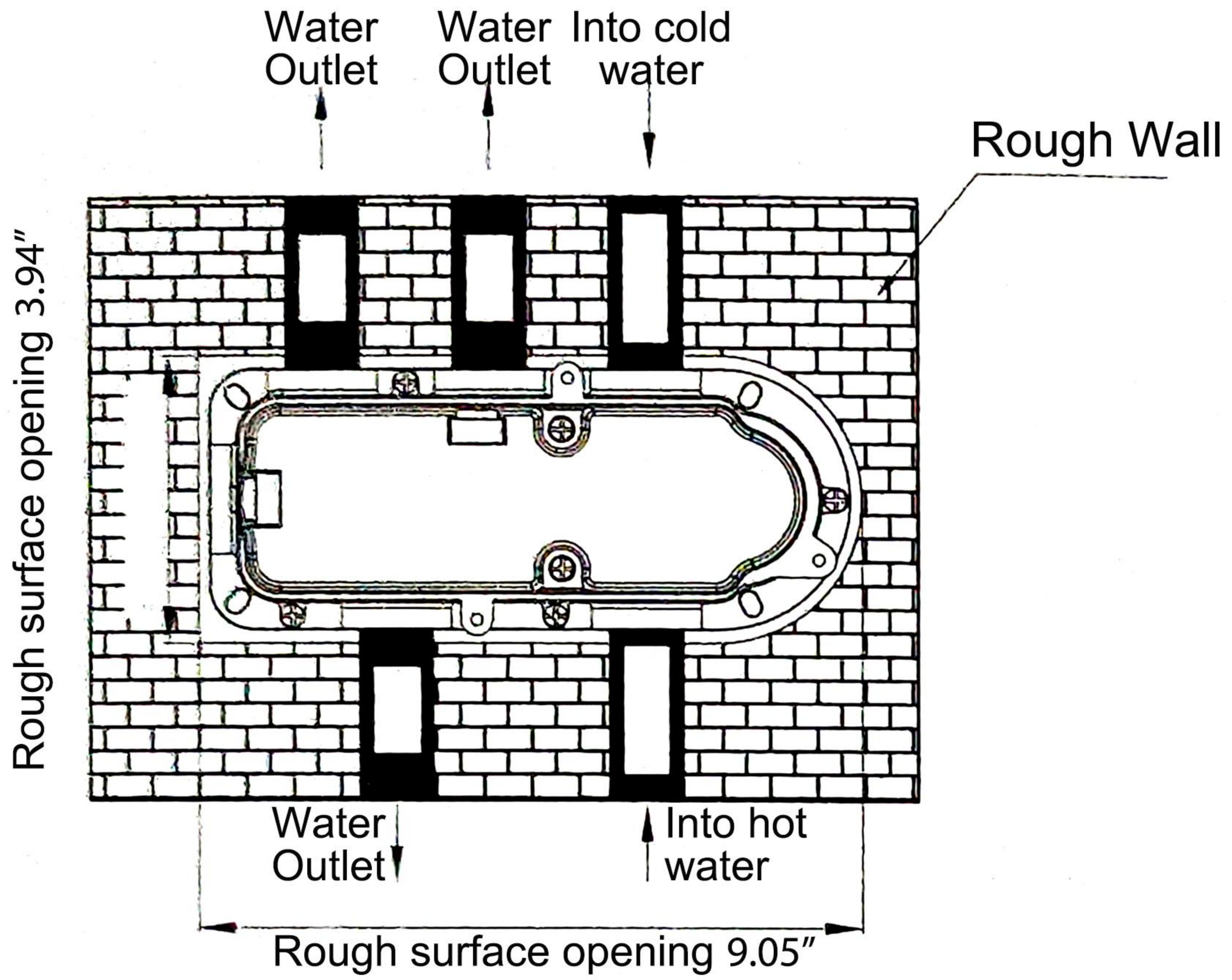

Attention:

- 1 The depth of the tile surface to the bottom of the hole should not exceed 80-90mm.
- 2 gross bad surface to the depth of the bottom of the hole about 60mm;
3. Paste tile cement plus tile thickness paper 30mm, more or less than More or less than 30m of the gross surface to the bottom of the hole depth needs to be reduced or increased accordingly.

This tile surface openings refer to the pre-embedded boxes and panels

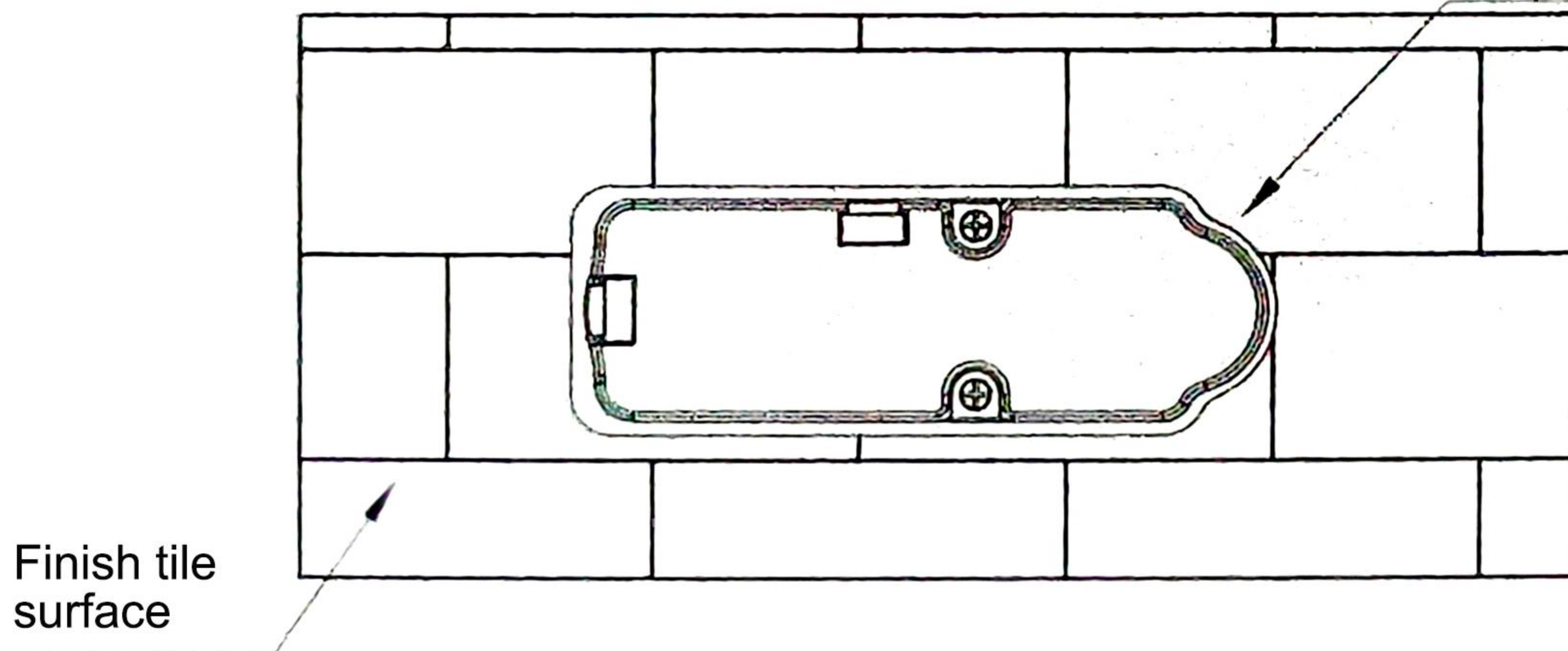

PIPING INSTALLATION SCHEMATIC

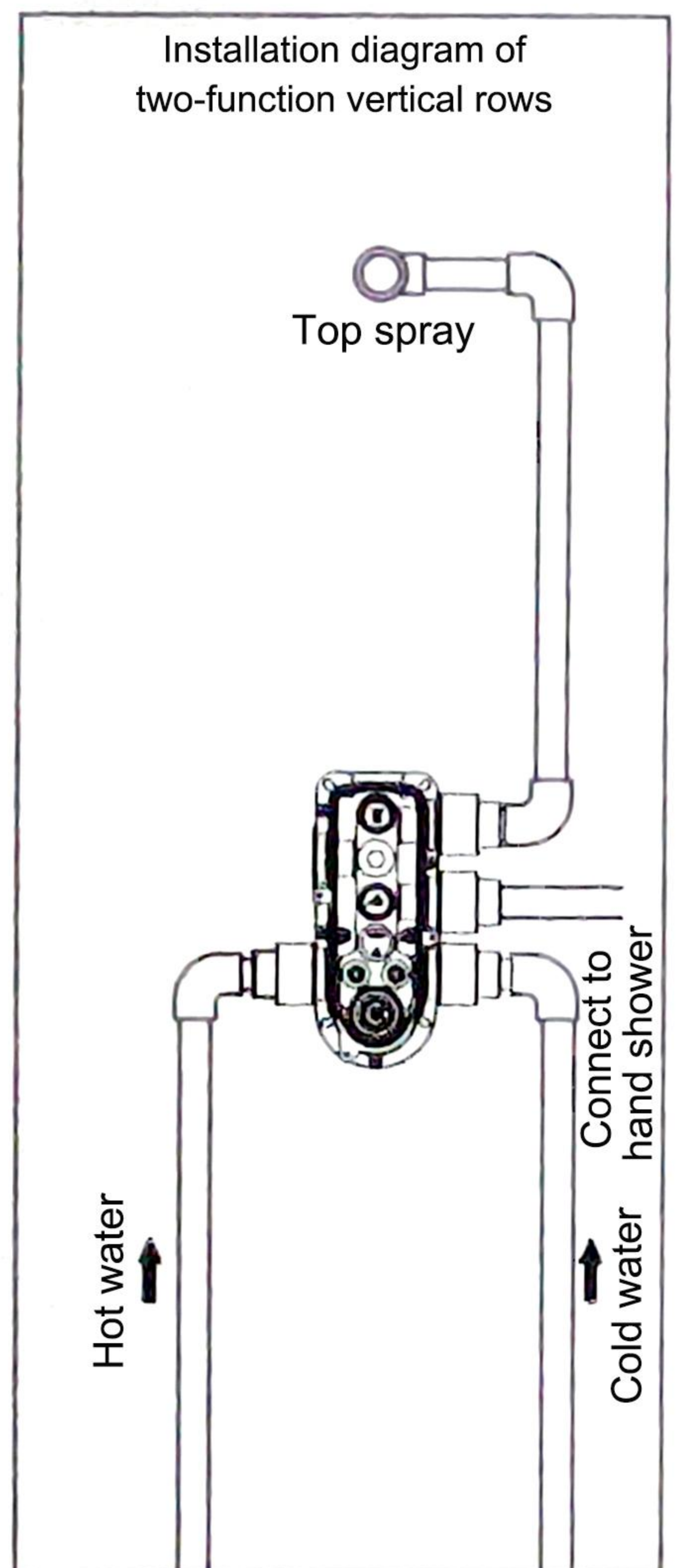
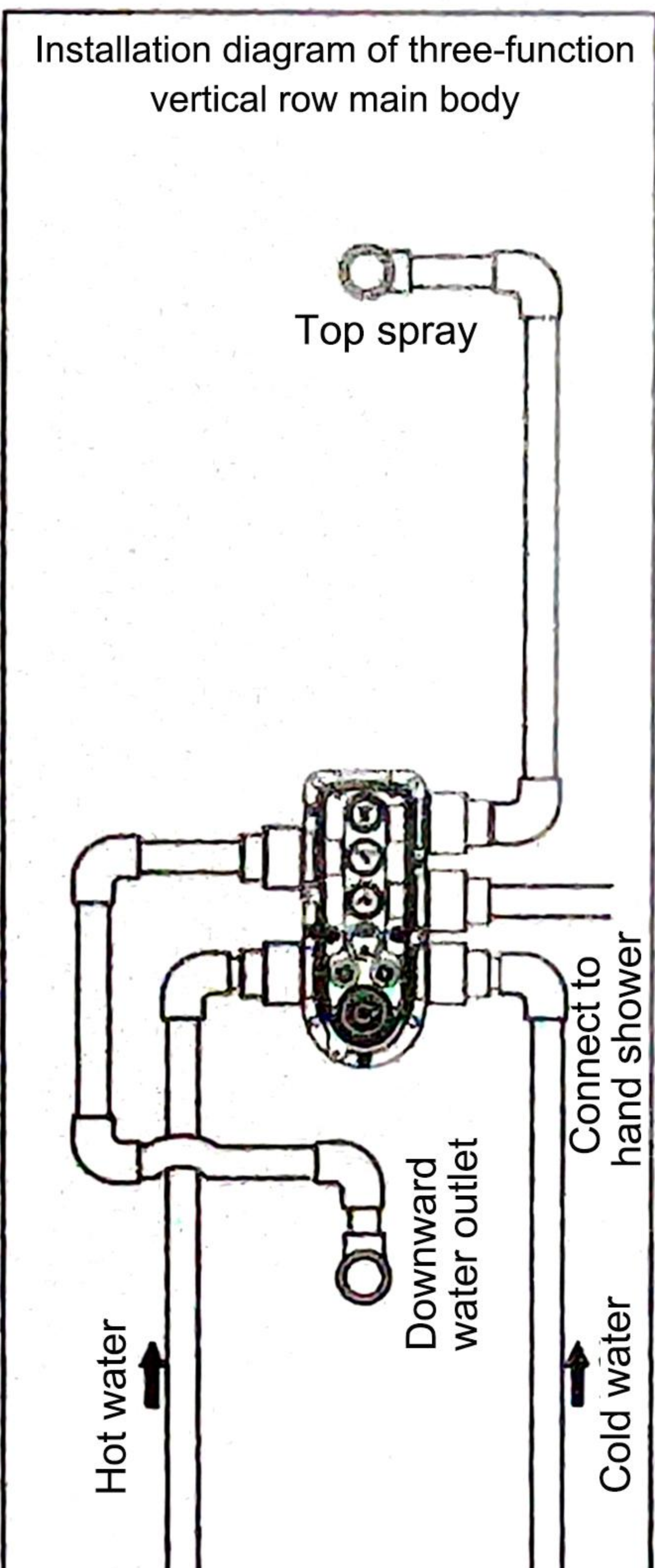
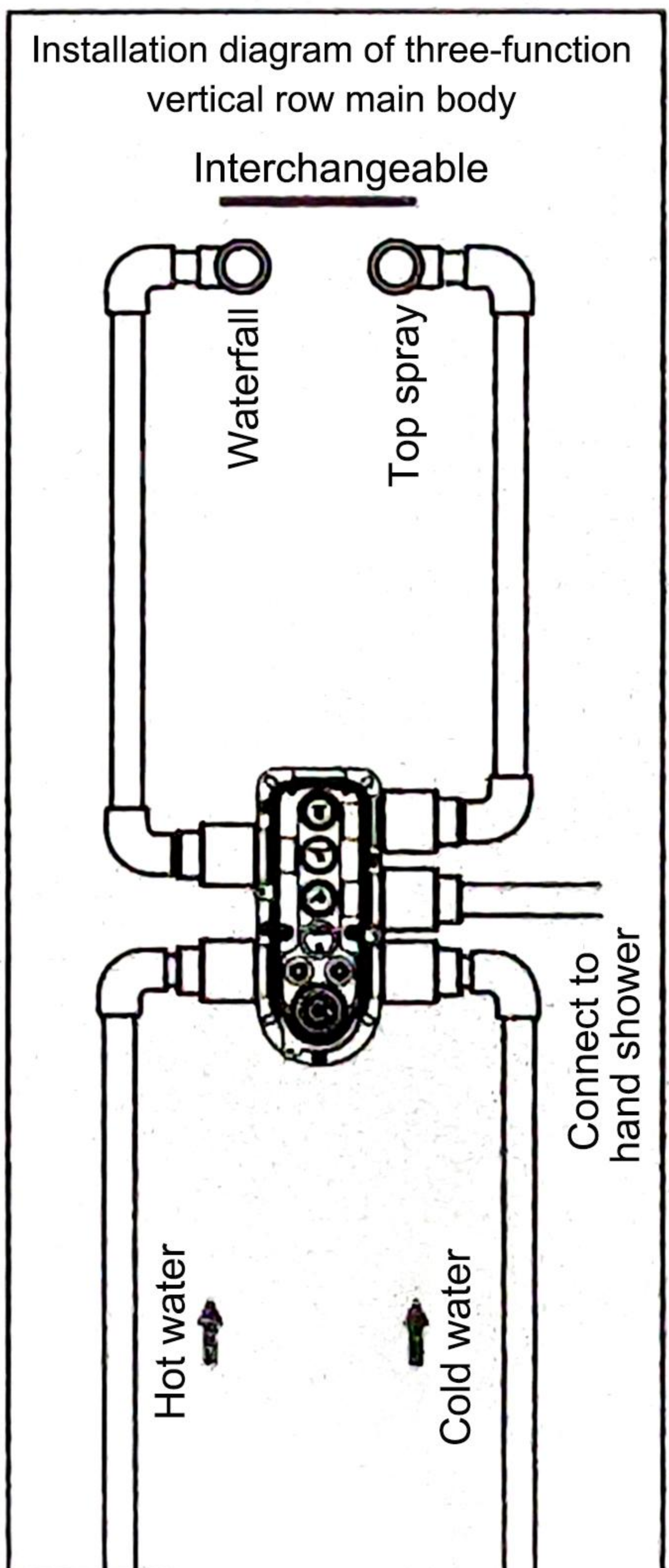
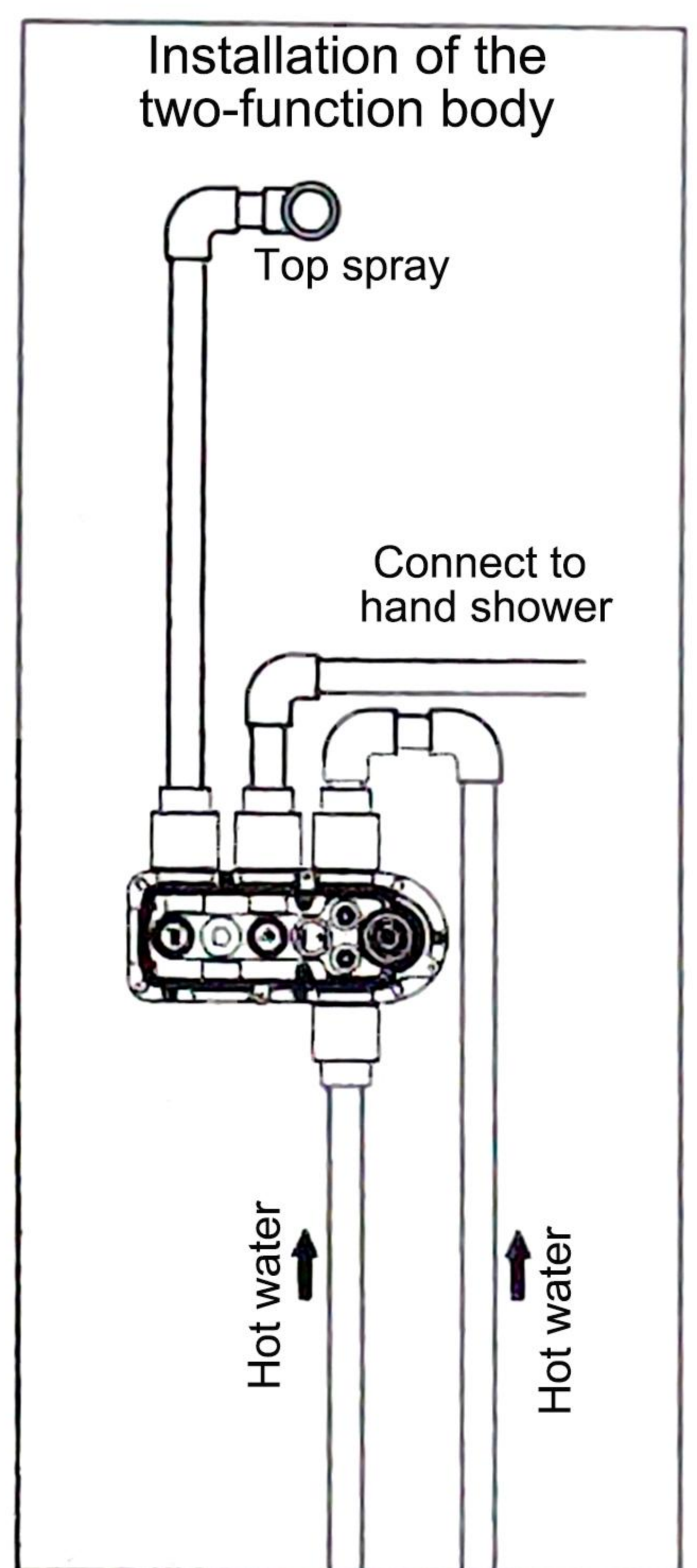
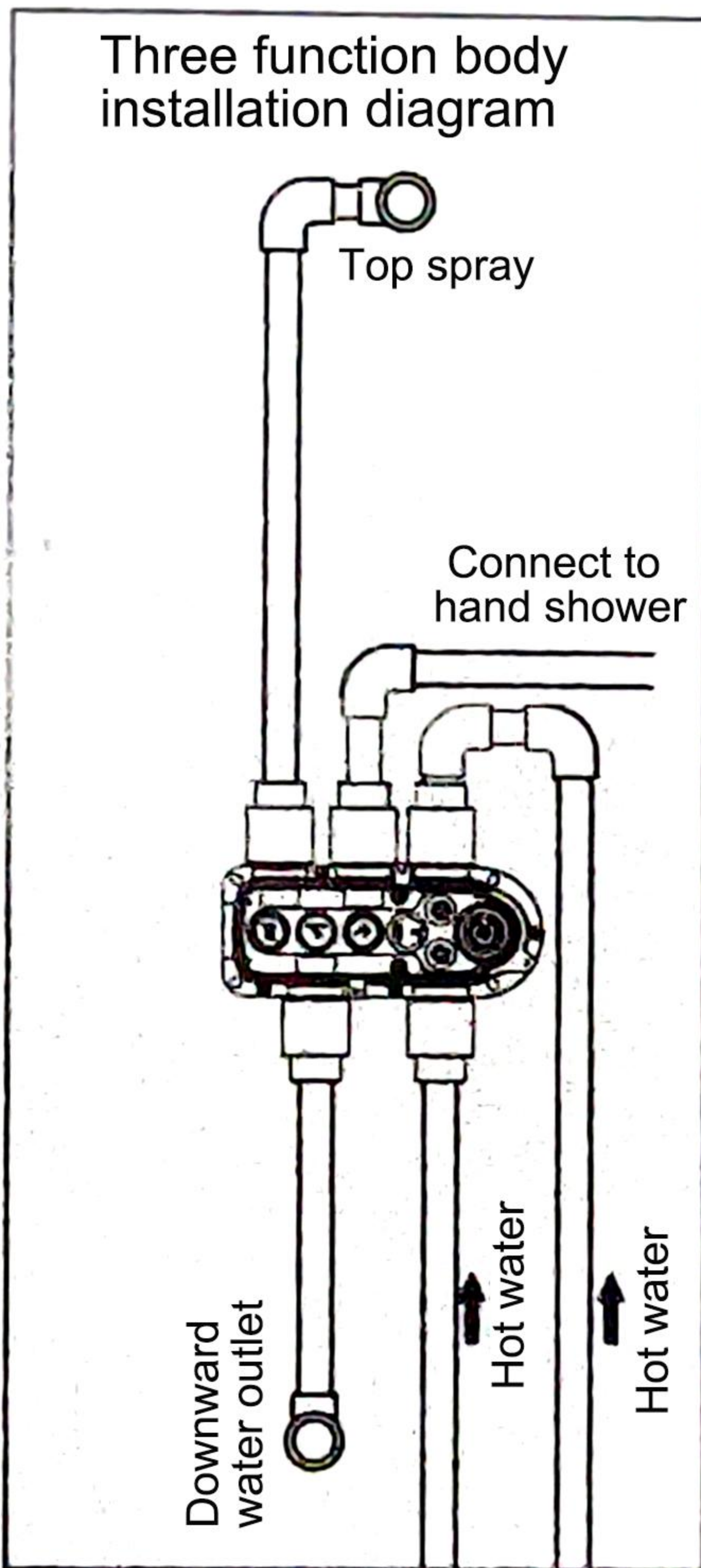
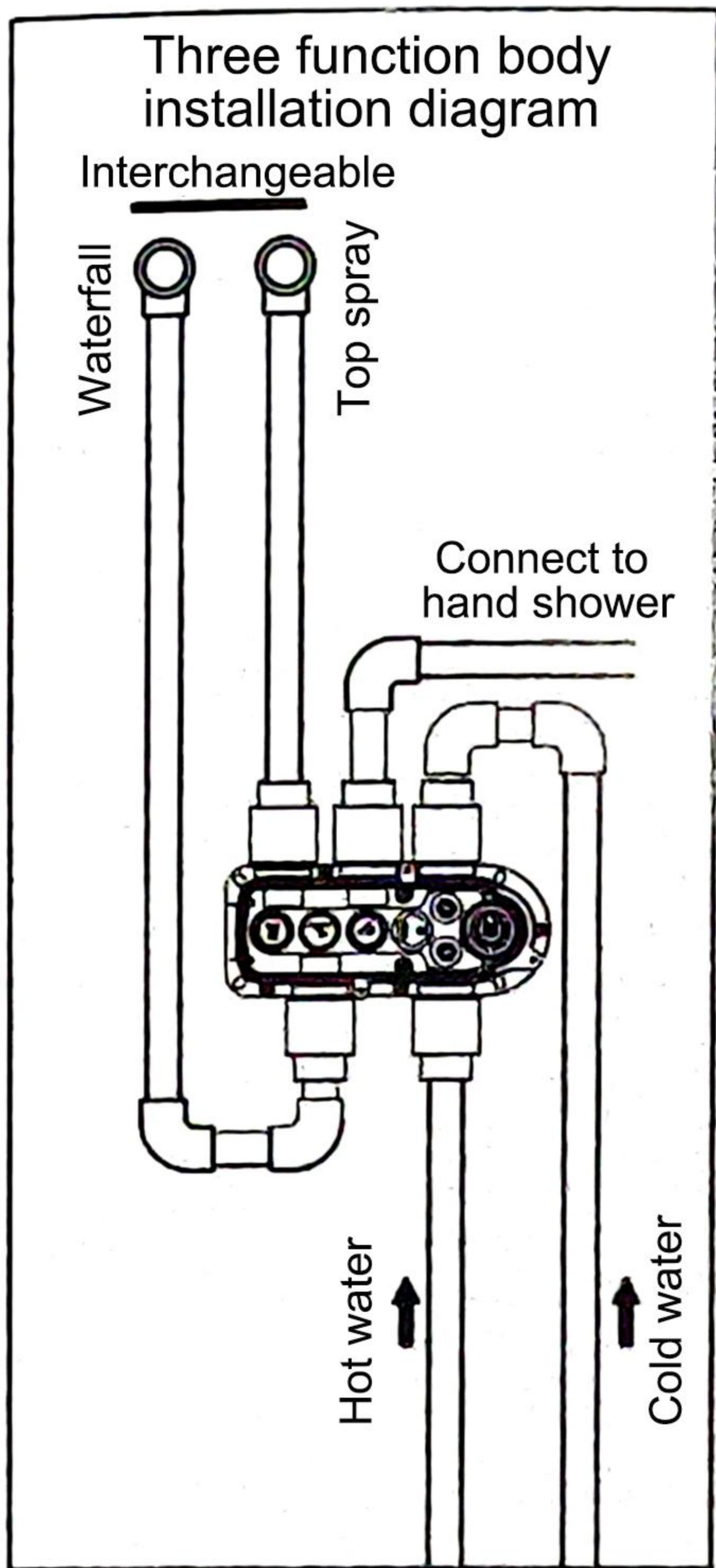

HANDLE INSTALLATION

1. After tiling the wall, remove the transparent cover of the pre-embedded box, pick up the panel 1, and plug in the two connectors 2 and 3 of the display and water flow generator one by one; Turn on the water to test the temperature display shows whether it is normal, and then cover the panel 1, cover the following figure:

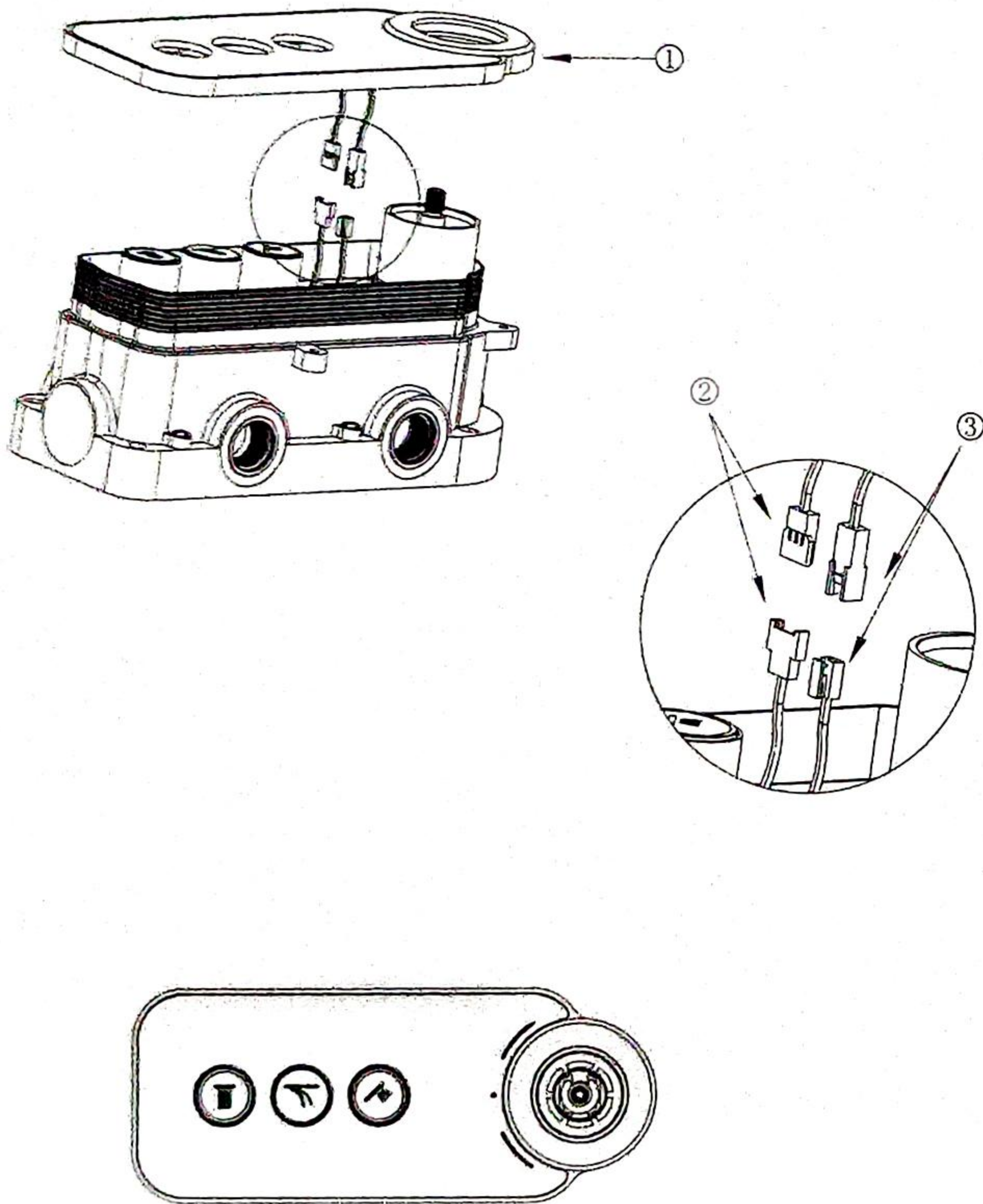

Schematic diagram after the panel is covered

1. Check whether the thermostatic spool temperature marking line is aligned as shown in the figure (this is the factory detection of the thermostatic spool temperature marking line);

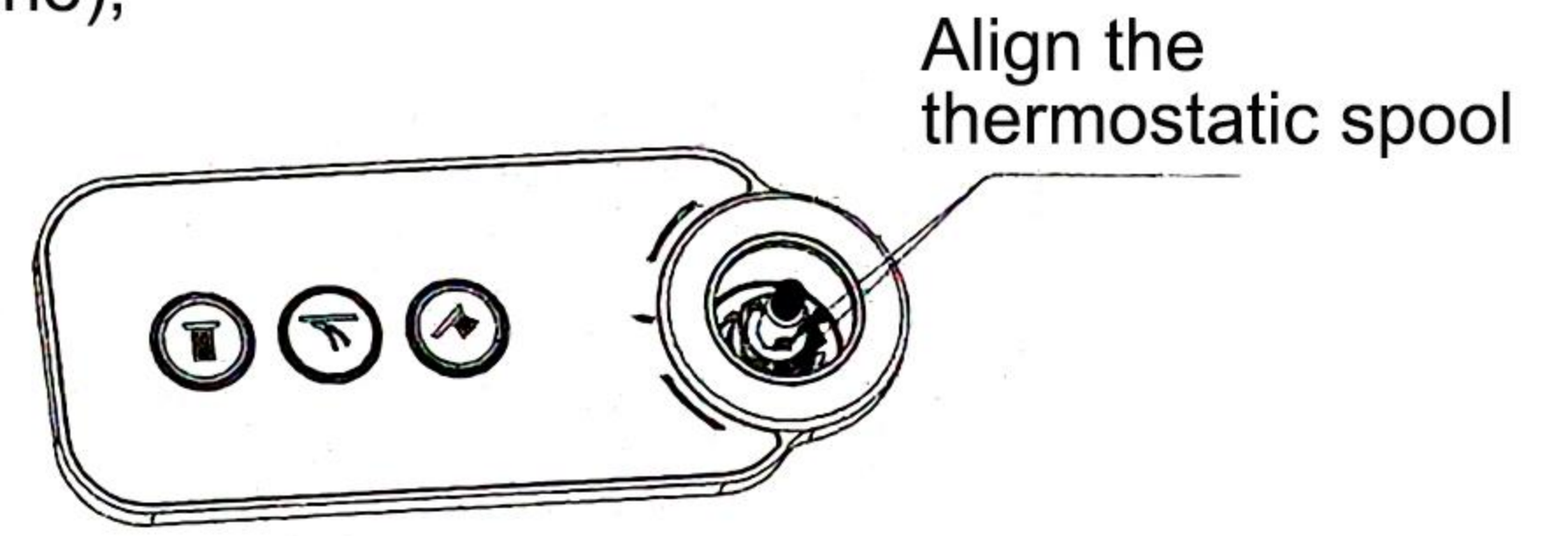

2. Insert the handwheel 4 in the direction shown in the illustration with the spool (handwheel and panel marking points aligned with the direction) coupling, lock screws 5, and then fasten the handwheel decorative cover 6. Then fasten the handwheel decorative cover 6; so that the handwheel installation after the following figure;

Handwheel installation
Align the marking point

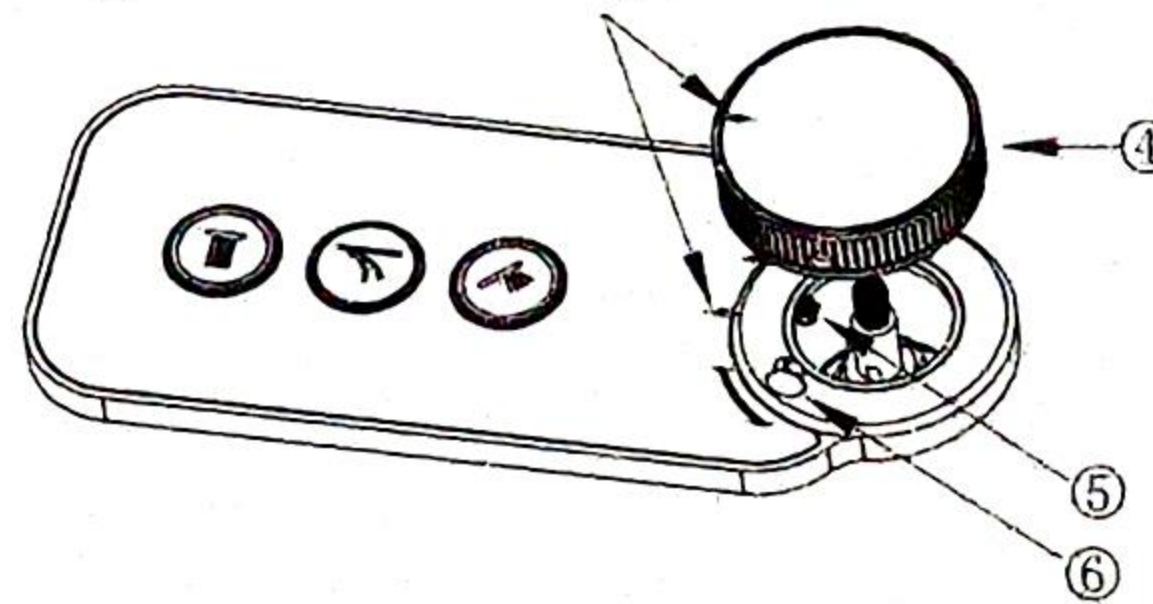

Handwheel installation
Align the marking point

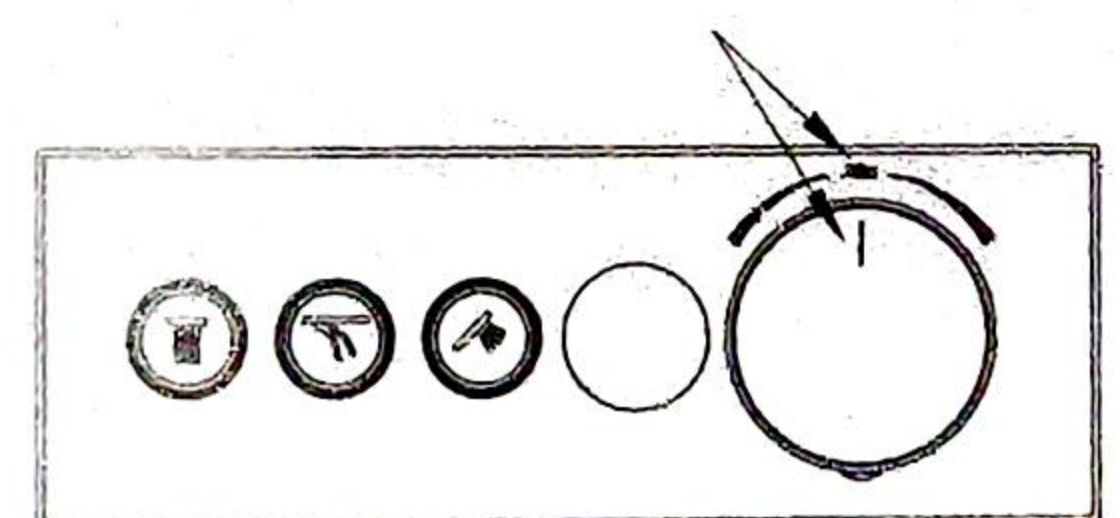

The depth of the top spray box buried to the tile surface: 2.76-3.15"

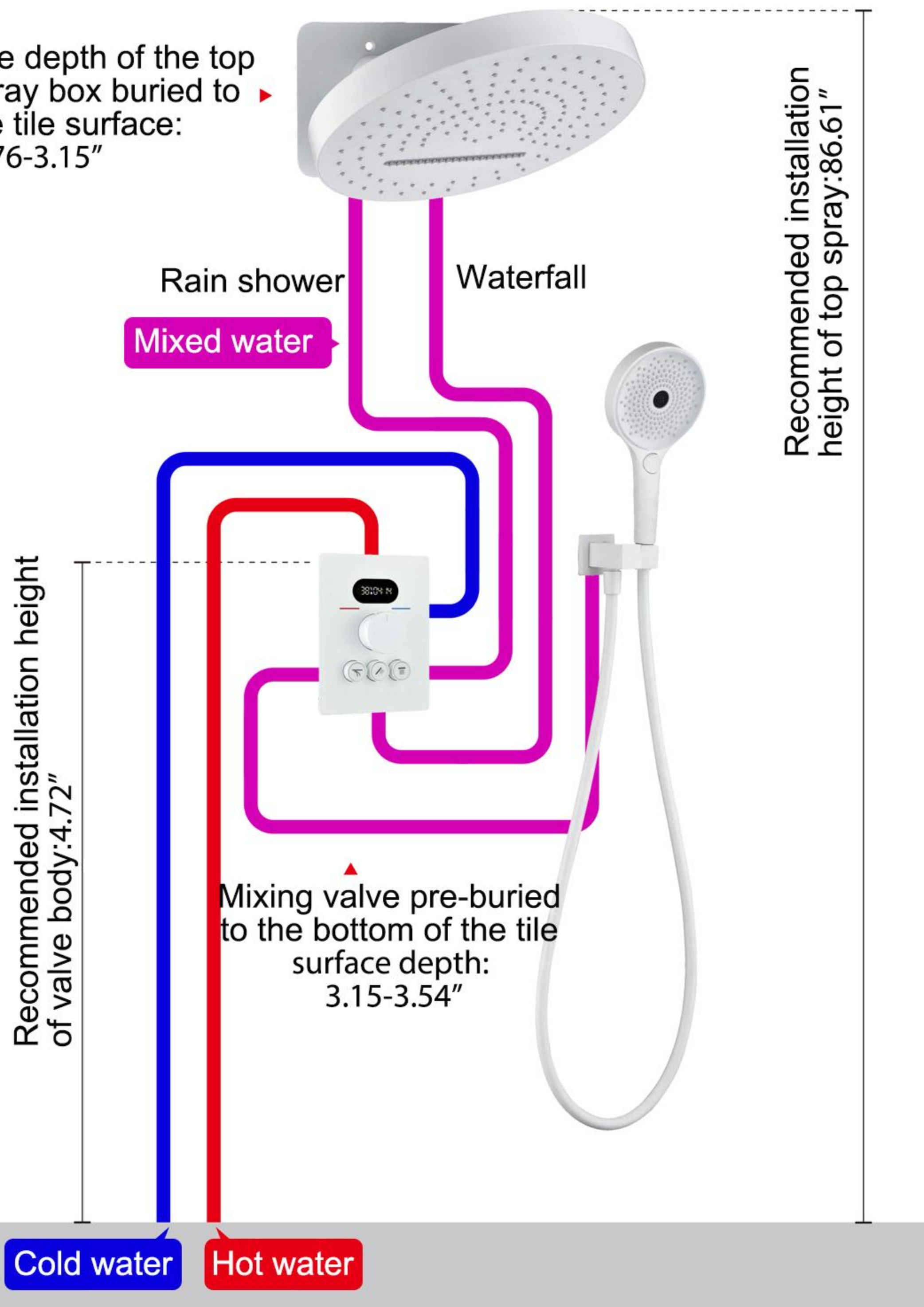

Installation Note:

Need to be pre-buried before tiling

(The pre-buried pipe should be cleaned thoroughly before installing the product to avoid clogging)

Hair bad surface opening size.

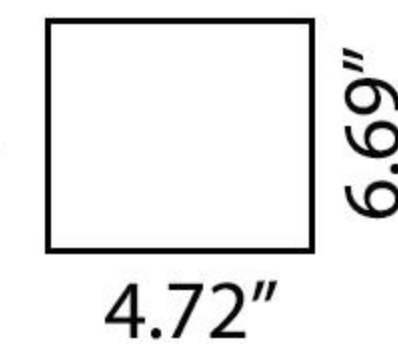

Mixing valve pre-buried to the bottom of the tile surface depth: 3.15-3.54"

The depth of the top spray box buried to the tile surface: 2.76-3.15"

PPR water pipe requirements:

inlet pipe 4 points
Outlet pipe 4 minutes (self-provided)

Use of environmental requirements.

1. Hot water to the faucet end 55-65 °, cold water 4-29 °;
2. Water pressure range recommended 1-5kg, below or above to be adjusted with a booster pump or pressure reducing valve;
3. Hot and cold water pipe direction, left hot and right cold

Ambient temperature: 5°-45

Applicable water heaters: solar water heaters, air water heaters Storage water heater, gas water heater (can not be connected to the pressureless water heater)

INSTALLATION STEPS

► Test method

1. Turn the faucet handle to the closed position, open the water inlet valve, and check whether there is any leakage at all water inlet ports.
2. Open the faucet handle to the maximum, and open the water inlet valve to check whether there is leakage at the water outlet and the sprinkler connection port.
3. Operate the reversing valve several times to check the shower water condition and whether there is any leakage outside the connection.
4. If the water pressure is lower than 0.05M Pa (it is possible that the faucet drips while the shower sprinkles water, or the faucet reversing valve does not work), a booster pump should be installed in the pipeline.

INSTALLATION DIMENSION

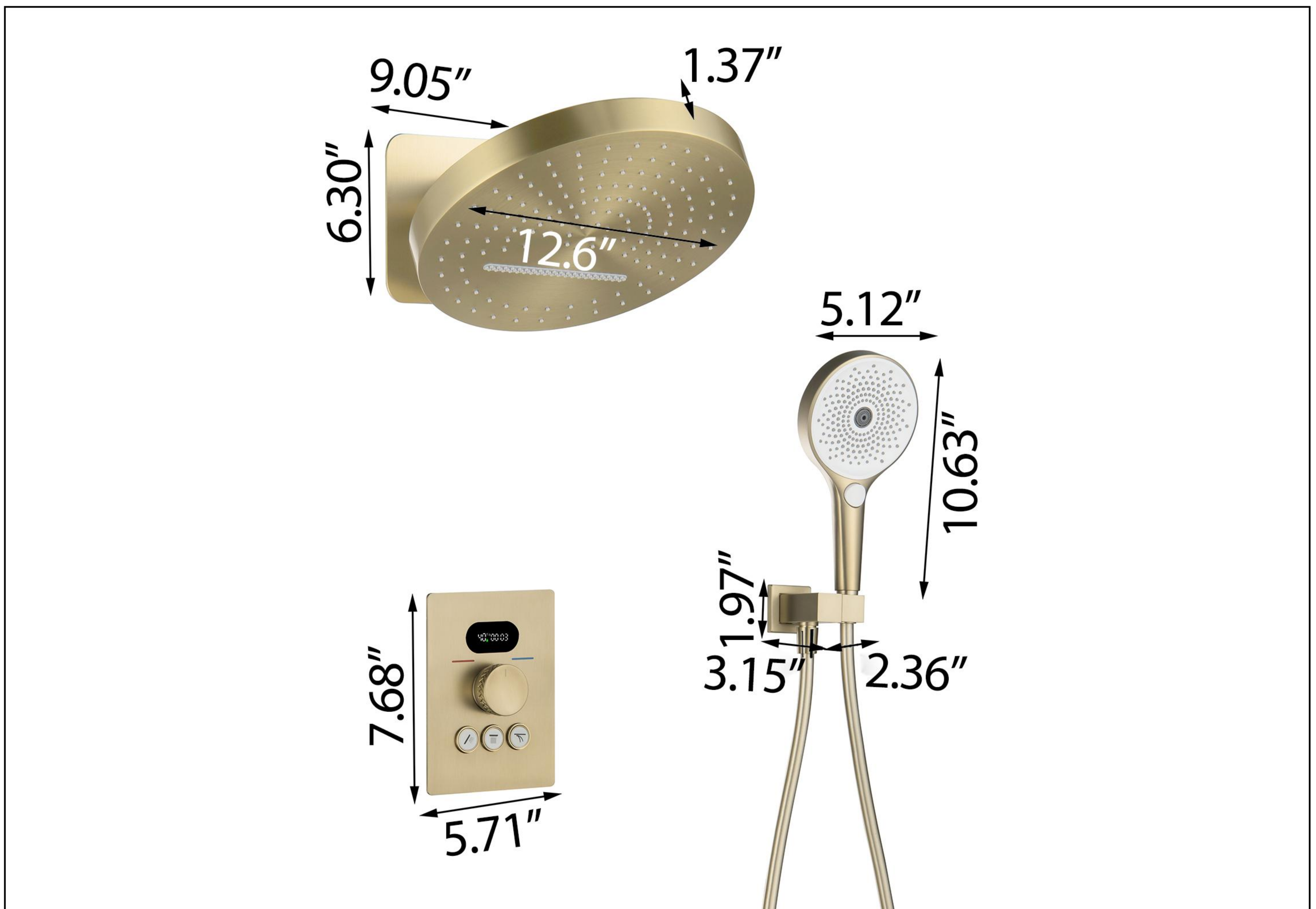

CLEANING CARE

In order to keep the appearance of faucet clean, bright and good performance, please take care of the faucet as follows;

1. Rinse with water only and dry with soft cotton cloth;
2. Use mild liquid and colorless glass cleaner to remove surface dirt and scale film, or use polish without abrasive effect;
3. Do not use abrasive detergent, polish, emery cloth, paper towel or scraper, etc.;
4. Do not use acid cleaner, or cleaner and soap with insoluble gran etc.;
5. In the process of use, mud may accumulate in the bubbler and make the water flow slow, The bubbler can be unscrewed, rinsed with water, and then installed back in place.



Please feel free to contact us if you have any questions. We will help to solve the issue together with you. OUR EMAIL: services@rbrohant.com

