

# Adjustable Bed User Guide

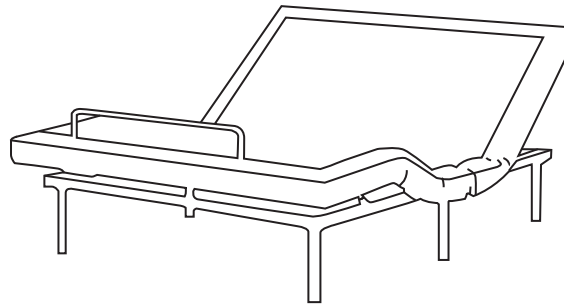

# Table of Contents

Safety Precautions .....	2
Product Specifications .....	3
Assembly .....	4
Remote Control and Functions .....	6
Memory Settings .....	7
Troubleshooting .....	8
Warranty .....	8
1. What is covered? .....	8
2. How Long Coverage Lasts .....	8
3. What is Not Covered? .....	8
After-sales Service .....	9

# Safety Precautions

Thank you for purchasing the Leisuit adjustable bed.

## PLEASE READ THE FOLLOWING INFORMATION CAREFULLY BEFORE USING THIS PRODUCT

If unable to understand warning, cautions, and/or instructions, contact the dealer or technical personnel if applicable, before attempting to use the equipment. Otherwise, injury or damage may result.

This product is intended for household use only. This product is covered by a limited ten-years warranty. Coverage is subject to limits and exclusions. See warranty for details.

- Use this product only for its intended purpose.
- Close supervision is necessary when this product is used by or near children or handicapped individuals.
- Never operate this product if it has a damaged cord or plug, or is not working properly.
- Keep the product, remote control, wires and power supply away from heat.
- Do not use this product in a humid environment. The connector part of the wire, and the gap between the motor and the control box, cannot be exposed to liquid or high humidity.
- Never use this product as a substitute for medical attention or treatment.
- Consult your physician if you have any questions regarding the use of this product.
- Do not use this product to treat any unexplained pain before consulting your physician.
- Stop using the product if you experience pain or swelling.
- Always unplug the product before attaching or detaching any parts or cleaning it.
- Unplug the power cord and remove the remote control battery when the product is not used for a prolonged period of time.
- Do not let children play with or operate this product.
- Do not allow children or pets underneath the bed.

### **RADIO FREQUENCY: 2.4 GHz**

#### **FCC COMPLIANCE:**

The wireless equipment of this product conforms to the FCC certification standard.

#### **CFR1633 COMPLIANCE:**







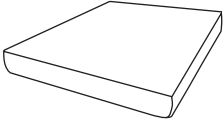

The fabric of this product passed the CFR1633 test.

# Product Specifications:

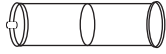
Product Size:

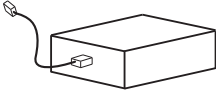
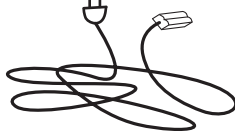
Twin XL: 38" x 80" (96.5 x 203 cm)    Full: 54" x 75" (137 x 190 cm)  
 Queen: 60" x 80" (152 x 203 cm)    King: 76" x 80" (198 x 203 cm)

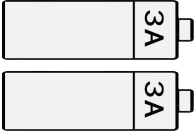
## Parts List

		
Bed platform X 1 pcs	Mattress rail X 1 pcs	Legs X 6 pcs
		
Remote controller X 1 pcs	Power Supply Box X 1pcs	Power Cable X 1pcs
		
DC extension cable X 1 pcs	AAA batteries X 2 pcs	User Guide X 1 pcs

**\* NOTE:** You may receive a sync cable for TXL size. This cable is only used for split king.

# Assembly

1. Lay the carton flat on the floor and carefully cut it open.
2. Lift the carton so that the open side faces down and slide it up and off the bed. Place the bed upside-down flat on the floor.
3. Remove and discard the plastic bag. Put together the two pieces of the bed and align them flat on the floor.
4. Cut the zip ties, take out all the part boxes and the mattress rail, and check that you have all the necessary parts according to the parts list.
5. For leg assembly push the screw through the triangular brace. Screw in the leg and tighten

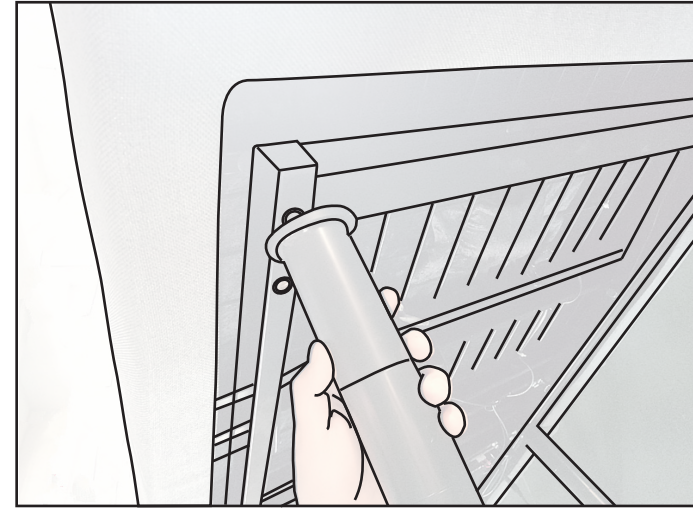

6. Connect the wire (on the bed) to the jack of power supply box. Connect the AC power cable to the other jack on the power supply box. Connect the AC power cable to your nearby power outlet.

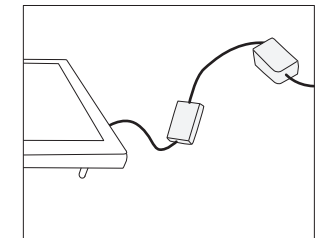
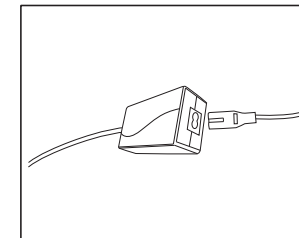
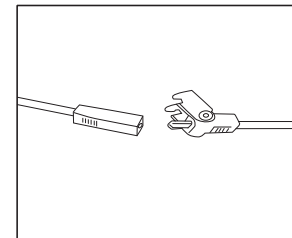

7. Insert batteries into the remote control. Press the first button. If the motor begins to run, unplug the power supply and turn the bed over to its right side-up position. If the motor does not run, it needs to re-match its code.

Matching code:

Method1: Cut off the power and waiting for 10 seconds. Then plug the power again.

You will see the arrow points to light up the blue light (like the circle shows in the first picture). At the same time, the LED lights will flash. Then press and hold the "PAIR" button of the remote control (like the third picture). This step must be done in 10 seconds when the LED lights flash. Release them when white backlight flashes. Finally, if the blue light in the controller turns to green and the LED lights go out, the code matches.

Method2: Press twice the controller button that the arrow points to light up the blue light (like the circle shows in the first picture). At the same time, the LED lights will flash. Then press and hold the "PAIR" button of the remote control (like the third picture). Release them when white backlight flashes. Finally, if the blue light in the controller turns to green and the LED lights go out, the code matches.

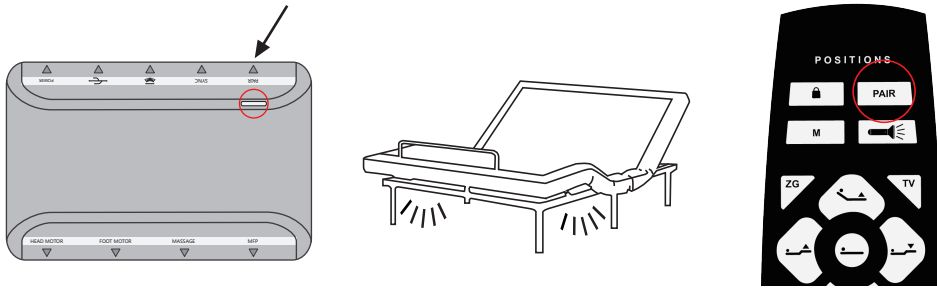



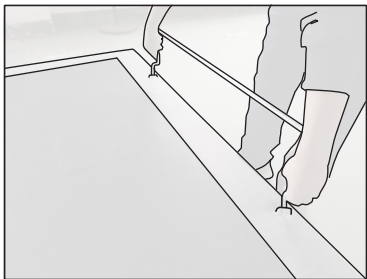



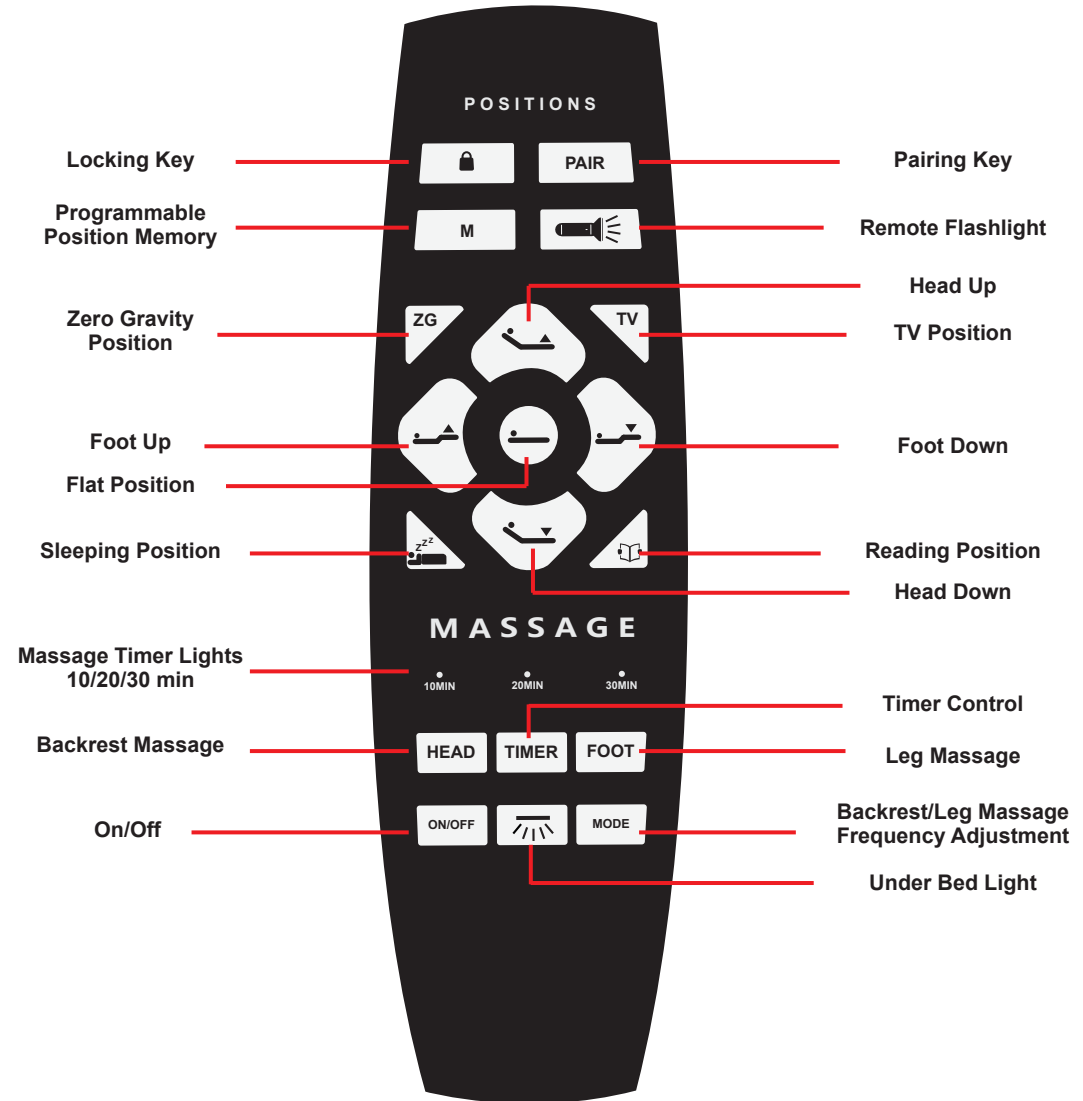



8. Insert the mattress rail at the foot of the bed. Then the bed is ready for use.











## Remote Control and Functions:



**Button      Operation**



-  Press and hold to raise the backrest. Let go when the desired position is reached.
-  Click to flatten the bed.
-  Press and hold to lower the backrest. Let go when the desired position is reached.
-  Click to lock the remote.
-  Click to set a user-defined position.
-  Click to set a zero gravity position. Position Angle: HEAD-16°, FOOT-35°
-  Click to set Sleeping position. Position Angle: HEAD-10°
-  Click to backrest massage and successively increase the intensity of the backrest massage in stages.
-  Click to leg massage and successively increase the intensity of the leg massage in stages.
-  Click to turn the LED flashlight under bed on and off.

**Button      Operation**

-  Press and hold to raise the footrest. Let go when the desired position is reached.
-  3.Press and hold to lower the footrest. Let go when the desired position is reached.
-  Click to match or re-match the control box.
-  Click to turn the LED flashlight on top of the remote on and off.
-  Click to set TV position. Position Angle: HEAD-44°, FOOT-26°.
-  Click to set Reading position. Position Angle: HEAD-30°, FOOT-15°.
-  Set massage time, 10 min, 20 min stages. Press 20 min. again to delete all settings.
-  Click to open or close the massage.
-  Backrest/Leg Massage Frequency Adjustment

**Memory Setting:**

Setting a memory position if you're not satisfied with the factory setting.

- 1.Press the FLAT button to flatten the bed. 
- 2.Adjust the bed to your preferred position by pressing the head and foot up/down buttons. 
- 3.Press and hold button M and let go after you hear the "didi" sound that indicates the setting has been successfully programmed.

**Split King/Dual Twin XL Sync Instructions**

1. Place two(2) Twin XL bases side by side.
2. Using a sync cable connect one bed to another.
3. Make sure that you plug the crystal head of sync cable into the port which marked "SYNC " on the control box.
4. With one remote, match the code for one bed. Follow the steps in matching code section. Just code for one bed.
5. You can use one remote to control two beds.

**\* NOTE:(SYNC CABLE: Only for split King. )**



**Troubleshooting:**

If you experience problems with your adjustable bed, please follow these steps:

- 1.Press any button on the remote control to see whether the blue backlight is bright. If it's dim or does not light, check the battery.
  - 2.Check the green power indicator light on the power supply. If it's not lit, check the power outlet.
  - 3.Check for loose wires or connectors.
  - 4.Check if the adjustable beds assembled according to the above steps.
- If your problems cannot be solved by the above steps, please contact us.

**Warranty**

**1.What is covered?**

This warranty covers any defects in materials or workmanship, with the exceptions stated below.

**2.How Long Coverage Lasts**

**10-years warranty**

The warranty of electrical equipment runs for 3 years from the date of purchase.(Electronics, electrical components, drive motors and massage motors are included.)

The warranty of metal bed frame runs for 10 years from the date of purchase.

**3.What is Not Covered?**

The warranty applies only to the original purchaser and does not cover:

- (a)wear and tear;
- (b)normal changes in softness or resilience (including impressions less than 1.5 inches in depth);
- (c)stains;
- (d)misuse or improper maintenance including use with an adjustable bed or wooden base;
- (e)alteration or repair by unauthorized representatives;
- (f)damage resulting from transit or handling.