

# ASSEMBLY INSTRUCTIONS INSTRUCTIONS DE MONTAGE INSTRUCCIONES DE MONTAJE

## NIGHTSTAND



**CAUTION:** PLEASE READ ALL INSTRUCTIONS BEFORE STARTING THE ASSEMBLY OF THIS PRODUCT. THESE PIECES ARE HEAVY. IN ORDER TO PREVENT PERSONAL INJURY AND ENSURE THAT THIS PRODUCT IS NOT DAMAGED DURING THE ASSEMBLY PROCESS, IT IS STRONGLY RECOMMENDED TO ENLIST THE ASSISTANCE OF ONE OR MORE PERSONS. IN CASE OF EXCESS STAIN, WIPE THE BOTTOM OF THE UNIT BEFORE PLACING ON ANY SURFACE.

**ATTENTION:** VEUILLEZ LIRE TOUTES LES INSTRUCTIONS AVANT DE COMMENCER L'ASSEMBLAGE DE CE PRODUIT. LES PIECES SONT LOURDES. POUR EVITER TOUTE BLESSURE ET POUR VOUS ASSURER QUE LE PRODUIT N'EST PAS ENDOMMAGE PENDANT L'ASSEMBLAGE, NOUS VOUS RECOMMANDONS DE FAIRE APPEL A UNE OU PLUSIEURS AUTRES PERSONNES. EN CAS DE TACHE EXCESSIVE, ESSUYEZ LE FOND DE L'UNITE AVANT LE PLACEMENT SUR N'IMPORTE QUELLE SURFACE.

**CUIDADO:** FAVOR DE LEER TODAS LAS INSTRUCCIONES ANTES DE ENSAMBLAR SU PRODUCTO. ESTAS PIEZAS SON PESADAS. PARA PREVENIR HERIDAS PERSONALES Y ASEGURAR QUE SU PRODUCTO NO SEA DAN ADO MIENTRAS ES ENSAMBLADO. SE RECOMIENDA LA ASISTENCIA DE UNA O MAUS PERSONAS.

**WARNING:** PROTECTIVE GLIDE IS PLACED UNDER EACH LEG OF THE FURNITURE TO RESIST SCRATCHES ON FLOOR SURFACE. SOME FLOOR SURFACES CAN BE EXTRA SENSITIVE TO SCRATCHES AND MARKINGS, IF YOU ARE NOT SURE CONSULT WITH YOUR DEALER.  
AVERTISSEMENT. LES PIEDS DES MEUBLES SONT MUNIS DE PATINS DESTINES A PROTEGER LE PLANCHER. CERTAINS REVETEMENTS DE SOL PEUVENT ETRE TRES FRAGILES. EN CAS DE DOUTE,CONSULTER LE MARCHAND.

### LIST OF PARTS AND HARDWARE/ LISTE DES PIÈCES ET DU MATÉRIEL/ LISTA DE PIEZAS Y HARDWARE

NO#/ NOMBRE/ NÚMERO	DESCRIPTION/ DESCRIPTION/ DESCRIPCIÓN	QUANTITY/ QUANTITÉ/ CANTIDAD
1	NIGHTSTAND/LA TABLE DE NUIT/MESITA DE NOCHE 	1 PC
2	TILT KIT BRACKET/ SUPPORT DE KIT D'INCLINAISON/ SOPORTE KIT INCLINACIÓN 	1 PC

NOTE:  
ASSEMBLE UNIT ON A SOFT SURFACE.  
ASSEMBLEZ L'UNITÉ SUR UNE SURFACE MOLLE.  
ENSAMBLE LA UNIDAD EN UNA SUPERFICIE PLANA Y SUAVE.

DO NOT TIGHTEN BOLTS UNTIL ALL PARTS AND HARDWARE OF THE UNIT ARE ASSEMBLED.  
NE SERREZ PAS LES BOULONS JUSQU'À CE QUE L'UNITÉ SOIT COMPLÈTEMENT ASSEMBLÉE.  
NO APRIETE LOS TORNILLOS HASTA QUE LA UNIDAD ESTE COMPLETAMENTE ENSAMBLADA.

# ASSEMBLY INSTRUCTIONS INSTRUCTIONS DE MONTAGE INSTRUCCIONES DE MONTAJE

## NIGHTSTAND

### STANDARD STEP TO REMOVE DRAWER

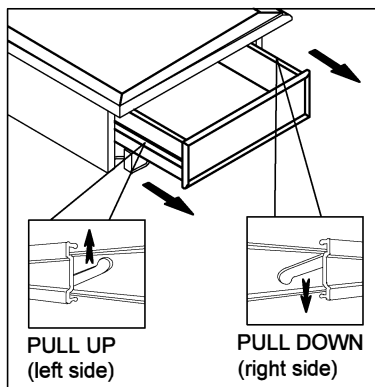

### BACK VIEW

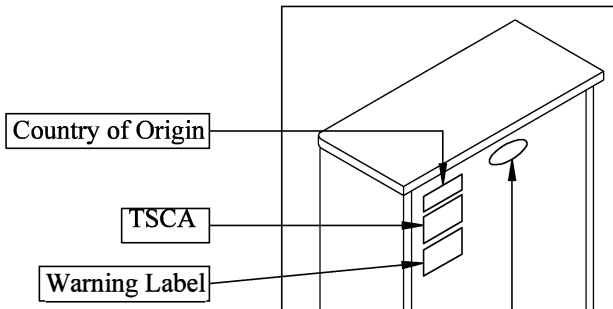

### TILT KIT BRACKET

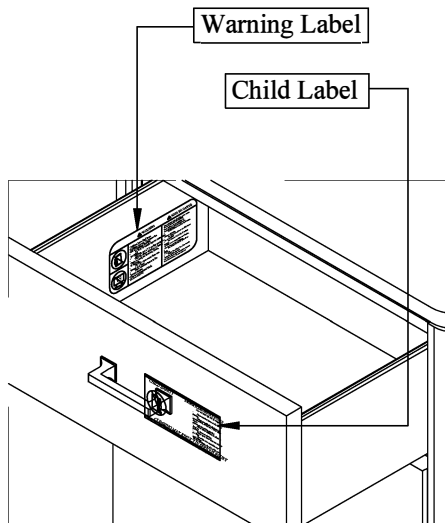
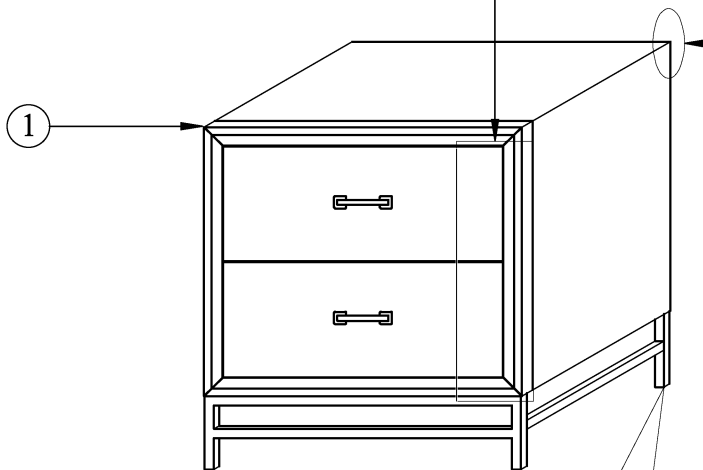
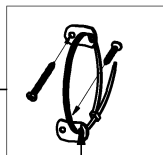

### TOP DRAWER

**NOTE:**

THE TABLE OR CASE SHOULD BE LOCKED IN POSITION AND LEVELLED USING A SPIRIT LEVEL. (SPIRIT LEVEL NOT INCLUDED)

LA TABLE OU LE BOÎTIER DOIT ÊTRE VERROUILLÉ EN POSITION ET NIVELÉ À L'AIDE D'UN NIVEAU À BULLE. (NIVEAU À BULLE NON INCLUS)

LA MESA O CAJA DEBE BLOQUEARSE EN SU POSICIÓN Y NIVELARSE CON UN NIVEL DE BURBUJA. (NIVEL DE BURBUJA NO INCLUIDO)



WARNING:  
ONLY USE THE HAND  
TOOLS PROVIDED

# ASSEMBLY INSTRUCTIONS INSTRUCTIONS DE MONTAGE INSTRUCCIONES DE MONTAJE

## OPEN NIGHTSTAND









**CAUTION:** PLEASE READ ALL INSTRUCTIONS BEFORE STARTING THE ASSEMBLY OF THIS PRODUCT. THESE PIECES ARE HEAVY. IN ORDER TO PREVENT PERSONAL INJURY AND ENSURE THAT THIS PRODUCT IS NOT DAMAGED DURING THE ASSEMBLY PROCESS, IT IS STRONGLY RECOMMENDED TO ENLIST THE ASSISTANCE OF ONE OR MORE PERSONS. IN CASE OF EXCESS STAIN, WIPE THE BOTTOM OF THE UNIT BEFORE PLACING ON ANY SURFACE.

**ATTENTION:** VEUILLEZ LIRE TOUTES LES INSTRUCTIONS AVANT DE COMMENCER L'ASSEMBLAGE DE CE PRODUIT. LES PIECES SONT LOURDES. POUR EVITER TOUTE BLESSURE ET POUR VOUS ASSURER QUE LE PRODUIT N'EST PAS ENDOMMAGE PENDANT L'ASSEMBLAGE, NOUS VOUS RECOMMANDONS DE FAIRE APPEL A UNE OU PLUSIEURS AUTRES PERSONNES. EN CAS DE TACHE EXCESSIVE, ESSUYEZ LE FOND DE L'UNITE AVANT LE PLACEMENT SUR N'IMPORTE QUELLE SURFACE.





**CUIDADO:** FAVOR DE LEER TODAS LAS INSTRUCCIONES ANTES DE ENSAMBLAR SU PRODUCTO, ESTAS PIEZAS SON PESADAS. PARA PREVENIR HERIDAS PERSONALES Y ASEGURAR QUE SU PRODUCTO NO SEA DANADO MIENTRAS ES ENSAMBLADO. SE RECOMIENDA LA ASISTENCIA DE UNA O MAS PERSONAS.

**WARNING:** PROTECTIVE GLIDE IS PLACED UNDER EACH LEG OF THE FURNITURE TO RESIST SCRATCHES ON FLOOR SURFACE. SOME FLOOR SURFACES CAN BE EXTRA SENSITIVE TO SCRATCHES AND MARKINGS, IF YOU ARE NOT SURE CONSULT WITH YOUR DEALER.  
AVERTISSEMENT. LES PIEDS DES MEUBLES SONT MUNIS DE PATINS DESTINES A PROTEGER LE PLANCHER. CERTAINS REVETEMENTS DE SOL PEUVENT ETRE TRES FRAGILES. EN CAS DE DOUTE, CONSULTER LE MARCHAND.

### LIST OF PARTS AND HARDWARE/ LISTE DES PIÈCES ET DU MATÉRIEL/ LISTA DE PIEZAS Y HARDWARE

NO#/ NOMBRE/ NÚMERO	DESCRIPTION/ DESCRIPTION/ DESCRIPCIÓN		QUANTITY/ QUANTITÉ/ CANTIDAD
A	BOLT/ BOULON/ TORNILLO 5/16"DIAMETER x 2"LENGTH		8 PCS
B	BOLT/ BOULON/ TORNILLO 1/4"DIAMETER x 5/8"LENGTH		8 PCS
C	LOCK WASHER/ RONDELLE DE BLOCAGE/ ARANDELA DE BLOQUEO 5/16"DIAMETER x 1/2"		8 PCS
D	FLAT WASHER/ RONDELLE PLATE/ ARANDELA PLANA 5/16"DIAMETER x 3/4"		8 PCS
E	LOCK WASHER/ RONDELLE DE BLOCAGE/ ARANDELA DE BLOQUEO 1/4"DIAMETER x 1/2"		8 PCS
F	FLAT WASHER/ RONDELLE PLATE/ ARANDELA PLANA 1/4"DIAMETER x 5/8"		8 PCS
G	SHELF CLIP 1-1/2" x 3/4"		4 PCS
H	ALLEN KEY/ CLÉ ALLEN/LLAVE INGLESA ALLEN 3/16"		1 PC

### LIST OF PARTS AND HARDWARE/ LISTE DES PIÈCES ET DU MATÉRIEL/ LISTA DE PIEZAS Y HARDWARE

NO#/ NOMBRE/ NÚMERO	DESCRIPTION/ DESCRIPTION/ DESCRIPCIÓN		QUANTITY/ QUANTITÉ/ CANTIDAD
1	NIGHTSTAND/LA TABLE DE NUIT/MESITA DE NOCHE		1 PC
2	LEG/ JAMBE/ PIERNA		1 PC
3	BOTTOM PANEL/PANNEAU DU BAS/PANEL INFERIOR		1 PC
4	TILT KIT BRACKET/ SUPPORT DE KIT D'INCLINAISON/ SOPORTE KIT INCLINACIÓN		1 PC

NOTE:  
ASSEMBLE UNIT ON A SOFT SURFACE.  
ASSEMBLEZ L'UNITÉ SUR UNE SURFACE MOLLE.  
ENSAMBLE LA UNIDAD EN UNA SUPERFICIE PLANA Y SUAVE.

DO NOT TIGHTEN BOLTS UNTIL ALL PARTS AND HARDWARE OF THE UNIT ARE ASSEMBLED.  
NE SERREZ PAS LES BOULONS JUSQU'À CE QUE L'UNITÉ SOIT COMPLÈTEMENT ASSEMBLÉE.  
NO APRIETE LOS TORNILLOS HASTA QUE LA UNIDAD ESTE COMPLETAMENTE ENSAMBLADA.

# ASSEMBLY INSTRUCTIONS INSTRUCTIONS DE MONTAGE INSTRUCCIONES DE MONTAJE

## OPEN NIGHTSTAND

### STANDARD STEP TO REMOVE DRAWER

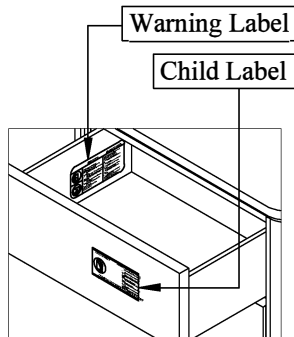
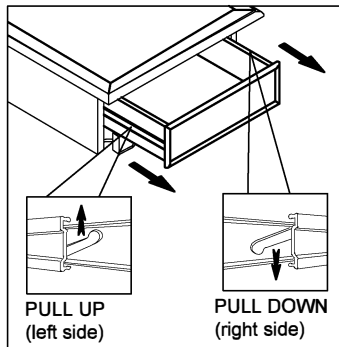

### TOP DRAWER

### BACK VIEW

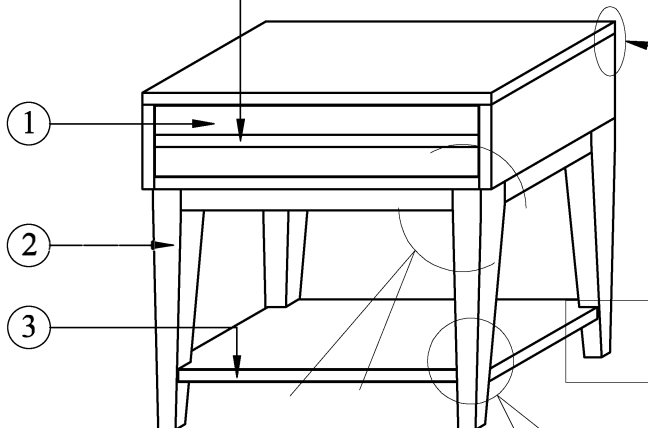
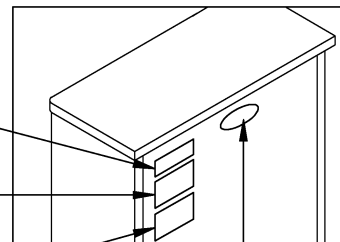

### TILT KIT BRACKET

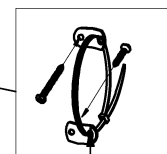

4



WARNING:  
ONLY USE THE HAND  
TOOLS PROVIDED

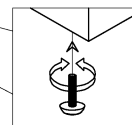

### LEVEL ME

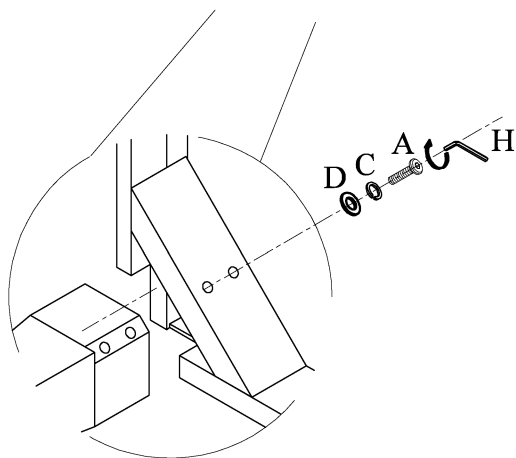

### STEP/ ÉTAPE/ PASO 1

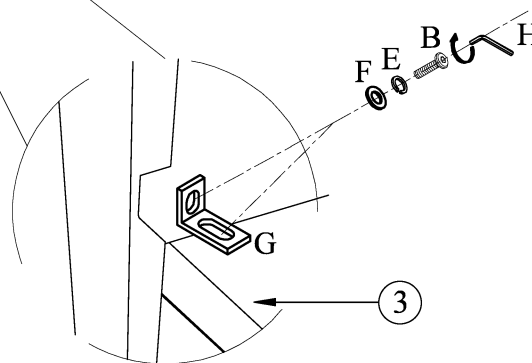

### STEP/ ÉTAPE/ PASO 2

**NOTE:**

THE TABLE OR CASE SHOULD BE LOCKED IN POSITION AND LEVELLED USING A SPIRIT LEVEL. (SPIRIT LEVEL NOT INCLUDED)  
LA TABLE OU LE BOÎTIER DOIT ÊTRE VERROUILLÉ EN POSITION ET NIVELÉ À L'AIDE D'UN NIVEAU À BULLE. (NIVEAU À BULLE NON INCLUS)  
LA MESA O CAJA DEBE BLOQUEARSE EN SU POSICIÓN Y NIVELARSE CON UN NIVEL DE BURBUJA. (NIVEL DE BURBUJA NO INCLUIDO)



WARNING:  
ONLY USE THE HAND  
TOOLS PROVIDED

# ASSEMBLY INSTRUCTIONS INSTRUCTIONS DE MONTAGE INSTRUCCIONES DE MONTAJE

## 10 DRAWER CHEST



**CAUTION:** PLEASE READ ALL INSTRUCTIONS BEFORE STARTING THE ASSEMBLY OF THIS PRODUCT. THESE PIECES ARE HEAVY. IN ORDER TO PREVENT PERSONAL INJURY AND ENSURE THAT THIS PRODUCT IS NOT DAMAGED DURING THE ASSEMBLY PROCESS, IT IS STRONGLY RECOMMENDED TO ENLIST THE ASSISTANCE OF ONE OR MORE PERSONS. IN CASE OF EXCESS STAIN, WIPE THE BOTTOM OF THE UNIT BEFORE PLACING ON ANY SURFACE.

**ATTENTION:** VEUILLEZ LIRE TOUTES LES INSTRUCTIONS AVANT DE COMMENCER L'ASSEMBLAGE DE CE PRODUIT. LES PIECES SONT LOURDES. POUR EVITER TOUTE BLESSURE ET POUR VOUS ASSURER QUE LE PRODUIT N'EST PAS ENDOMMAGE PENDANT L'ASSEMBLAGE, NOUS VOUS RECOMMANDONS DE FAIRE APPEL A UNE OU PLUSIEURS AUTRES PERSONNES. EN CAS DE TACHE EXCESSIVE, ESSUYEZ LE FOND DE L'UNITE AVANT LE PLACEMENT SUR N'IMPORTE QUELLE SURFACE.

**CUIDADO:** FAVOR DE LEER TODAS LAS INSTRUCCIONES ANTES DE ENSAMBLAR SU PRODUCTO, ESTAS PIEZAS SON PESADAS. PARA PREVENIR HERIDAS PERSONALES Y ASEGURAR QUE SU PRODUCTO NO SEA DANADO MIENTRAS ES ENSAMBLADO. SE RECOMIENDA LA ASISTENCIA DE UNA O MAS PERSONAS.

**WARNING:** PROTECTIVE GLIDE IS PLACED UNDER EACH LEG OF THE FURNITURE TO RESIST SCRATCHES ON FLOOR SURFACE. SOME FLOOR SURFACES CAN BE EXTRA SENSITIVE TO SCRATCHES AND MARKINGS, IF YOU ARE NOT SURE CONSULT WITH YOUR DEALER.  
AVERTISSEMENT. LES PIEDS DES MEUBLES SONT MUNIS DE PATINS DESTINES A PROTEGER LE PLANCHER. CERTAINS REVETEMENTS DE SOL PEUVENT ETRE TRES FRAGILES. EN CAS DE DOUTE CONSULTER LE MARCHAND.

### LIST OF PARTS AND HARDWARE/ LISTE DES PIÈCES ET DU MATÉRIEL/ LISTA DE PIEZAS Y HARDWARE

NO#/ NOMBRE/ NÚMERO	DESCRIPTION/ DESCRIPTION/ DESCRIPCIÓN		QUANTITY/ QUANTITÉ/ CANTIDAD
1	NIGHTSTAND/LA TABLE DE NUIT/MESITA DE NOCHE		1 PC
2	TILT KIT BRACKET/ SUPPORT DE KIT D'INCLINAISON/ SOPORTE KIT INCLINACIÓN		1 PC

**NOTE:**  
ASSEMBLE UNIT ON A SOFT SURFACE.  
ASSEMBLEZ L'UNITÉ SUR UNE SURFACE MOLLE.  
ENSAMBLE LA UNIDAD EN UNA SUPERFICIE PLANA Y SUAVE.

DO NOT TIGHTEN BOLTS UNTIL ALL PARTS AND HARDWARE OF THE UNIT ARE ASSEMBLED.  
NE SERREZ PAS LES BOULONS JUSQU'À CE QUE L'UNITÉ SOIT COMPLÈTEMENT ASSEMBLÉE.  
NO APRIETE LOS TORNILLOS HASTA QUE LA UNIDAD ESTE COMPLETAMENTE ENSAMBLADA.

# ASSEMBLY INSTRUCTIONS INSTRUCTIONS DE MONTAGE INSTRUCCIONES DE MONTAJE

## 10 DRAWER CHEST

### STANDARD STEP TO REMOVE DRAWER

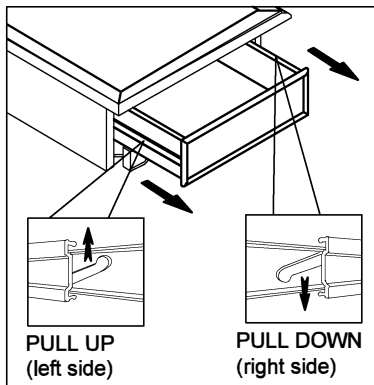

### BACK VIEW

Country of Origin

TSCA

Warning Label

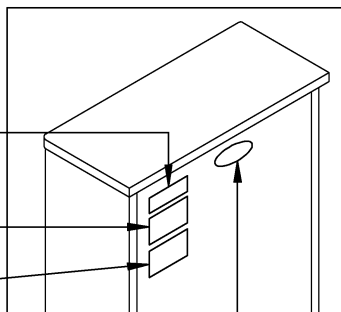

TILT KIT BRACKET

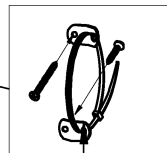

1

2

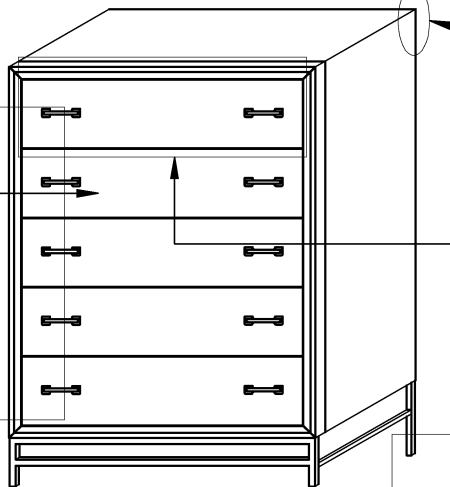

LEVEL ME

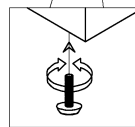

Warning Label

Child Label

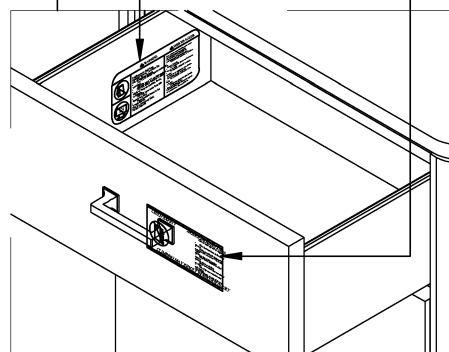

TOP DRAWER

**NOTE:**

THE TABLE OR CASE SHOULD BE LOCKED IN POSITION AND LEVELLED USING A SPIRIT LEVEL. (SPIRIT LEVEL NOT INCLUDED)

LA TABLE OU LE BOÎTIER DOIT ÊTRE VERROUILLÉ EN POSITION ET NIVELÉ À L'AIDE D'UN NIVEAU À BULLE. (NIVEAU À BULLE NON INCLUS)

LA MESA O CAJA DEBE BLOQUEARSE EN SU POSICIÓN Y NIVELARSE CON UN NIVEL DE BURBUJA. (NIVEL DE BURBUJA NO INCLUIDO)



WARNING:  
ONLY USE THE HAND  
TOOLS PROVIDED

# ASSEMBLY INSTRUCTIONS INSTRUCTIONS DE MONTAGE INSTRUCCIONES DE MONTAJE

HOME

## DRESSER



**CAUTION:** PLEASE READ ALL INSTRUCTIONS BEFORE STARTING THE ASSEMBLY OF THIS PRODUCT. THESE PIECES ARE HEAVY. IN ORDER TO PREVENT PERSONAL INJURY AND ENSURE THAT THIS PRODUCT IS NOT DAMAGED DURING THE ASSEMBLY PROCESS, IT IS STRONGLY RECOMMENDED TO ENLIST THE ASSISTANCE OF ONE OR MORE PERSONS. IN CASE OF EXCESS STAIN, WIPE THE BOTTOM OF THE UNIT BEFORE PLACING ON ANY SURFACE.

**ATTENTION:** VEUILLEZ LIRE TOUTES LES INSTRUCTIONS AVANT DE COMMENCER L'ASSEMBLAGE DE CE PRODUIT. LES PIECES SONT LOURDES. POUR EVITER TOUTE BLESSURE ET POUR VOUS ASSURER QUE LE PRODUIT N'EST PAS ENDOMMAGE' PENDANT L'ASSEMBLAGE, NOUS VOUS RECOMMANDONS DE FAIRE APPEL A UNE OU PLUSIEURS AUTRES PERSONNES. EN CAS DE TACHE EXCESSIVE, ESSUYEZ LE FOND DE L'UNITE' AVANT LE PLACEMENT SUR N'IMPORTE QUELLE SURFACE.

**CUIDADO:** FAVOR DE LEER TODAS LAS INSTRUCCIONES ANTES DE ENSAMBLAR SU PRODUCTO, ESTAS. PIEZAS SON PESADAS. PARA PREVENIR HERIDAS PERSONALES Y ASEGURAR QUE SU PRODUCTO NO SEA DAN ADO MIENTRAS ES ENSAMBLADO. SE RECOMIENDA LA ASISTENCIA DE UNA O MAUS PERSONAS.

**WARNING:** PROTECTIVE GLIDE IS PLACED UNDER EACH LEG OF THE FURNITURE TO RESIST SCRATCHES ON FLOOR SURFACE. SOME FLOOR SURFACES CAN BE EXTRA SENSITIVE TO SCRATCHES AND MARKINGS, IF YOU ARE NOT SURE CONSULT WITH YOUR DEALER.  
AVERTISSEMENT. LES PIEDS DES MEUBLES SONT MUNIS DE PATINS DESTINES A PROTEGER LE PLANCHER. CERTAINS REVETEMENTS DE SOL PEUVENT ETRE TRES FRAGILES. EN CAS DE DOUTE. CONSULTER LE MARCHAND.

### LIST OF PARTS AND HARDWARE/ LISTE DES PIÈCES ET DU MATÉRIEL/ LISTA DE PIEZAS Y HARDWARE

NO#/ NOMBRE/ NÚMERO	DESCRIPTION/ DESCRIPTION/ DESCRIPCIÓN		QUANTITY/ QUANTITÉ/ CANTIDAD
1	NIGHTSTAND/LA TABLE DE NUIT/MESITA DE NOCHE		1 PC
2	TILT KIT BRACKET/ SUPPORT DE KIT D'INCLINAISON/ SOPORTE KIT INCLINACIÓN		1 PC

NOTE:  
ASSEMBLE UNIT ON A SOFT SURFACE.  
ASSEMBLEZ L'UNITÉ SUR UNE SURFACE MOLLE.  
ENSAMBLE LA UNIDAD EN UNA SUPERFICIE PLANA Y SUAVE.

DO NOT TIGHTEN BOLTS UNTIL ALL PARTS AND HARDWARE OF THE UNIT ARE ASSEMBLED.  
NE SERREZ PAS LES BOULONS JUSQU'À CE QUE L'UNITÉ SOIT COMPLÈTEMENT ASSEMBLÉE.  
NO APRIETE LOS TORNILLOS HASTA QUE LA UNIDAD ESTE COMPLETAMENTE ENSAMBLADA.

# ASSEMBLY INSTRUCTIONS INSTRUCTIONS DE MONTAGE INSTRUCCIONES DE MONTAJE

## DRESSER CHEST

### STANDARD STEP TO REMOVE DRAWER

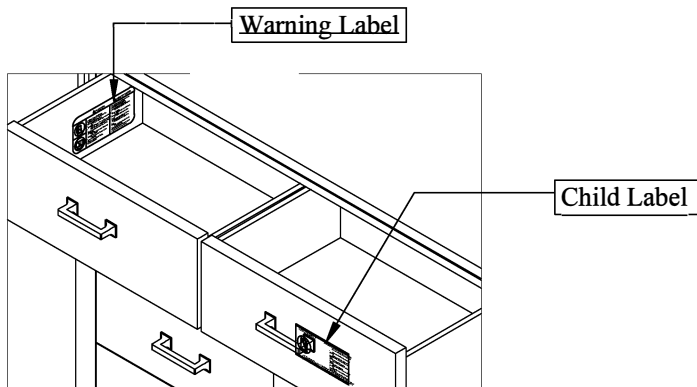
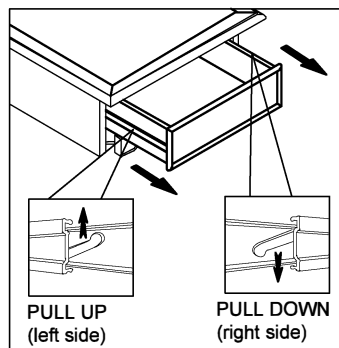

TOP DRAWER

TILT KIT BRACKET

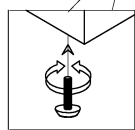
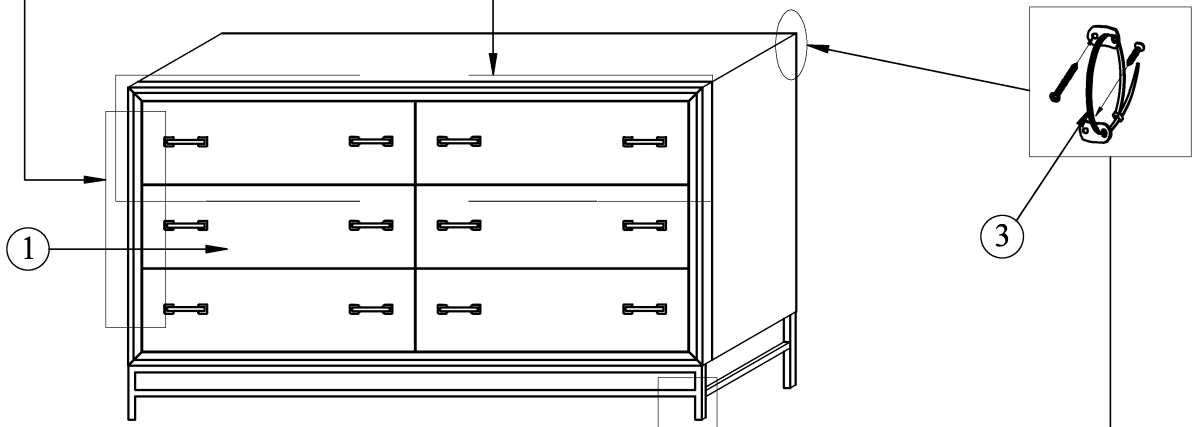

LEVEL ME

Country of Origin

TSCA

Warning Label

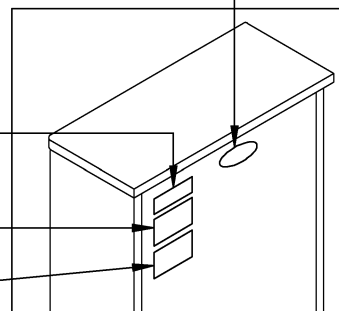

BACK VIEW

**NOTE:**

THE TABLE OR CASE SHOULD BE LOCKED IN POSITION AND LEVELLED USING A SPIRIT LEVEL. (SPIRIT LEVEL NOT INCLUDED)

LA TABLE OU LE BOÎTIER DOIT ÊTRE VERROUILLÉ EN POSITION ET NIVELÉ À L'AIDE D'UN NIVEAU À BULLE. (NIVEAU À BULLE NON INCLUS)

LA MESA O CAJA DEBE BLOQUEARSE EN SU POSICIÓN Y NIVELARSE CON UN NIVEL DE BURBUJA. (NIVEL DE BURBUJA NO INCLUIDO)



WARNING:  
ONLY USE THE HAND  
TOOLS PROVIDED

# ASSEMBLY INSTRUCTIONS INSTRUCTIONS DE MONTAGE INSTRUCCIONES DE MONTAJE

## MIRROR FRAME





**CAUTION:** PLEASE READ ALL INSTRUCTIONS BEFORE STARTING THE ASSEMBLY OF THIS PRODUCT. THESE PIECES ARE HEAVY. IN ORDER TO PREVENT PERSONAL INJURY AND ENSURE THAT THIS PRODUCT IS NOT DAMAGED DURING THE ASSEMBLY PROCESS, IT IS STRONGLY RECOMMENDED TO ENLIST THE ASSISTANCE OF ONE OR MORE PERSONS. IN CASE OF EXCESS STAIN, WIPE THE BOTTOM OF THE UNIT BEFORE PLACING ON ANY SURFACE.

**ATTENTION:** VEUILLEZ LIRE TOUTES LES INSTRUCTIONS AVANT DE COMMENCER L'ASSEMBLAGE DE CE PRODUIT. LES PIÉCES SONT LOURDES. POUR ÉVITER TOUTE BLESSURE ET POUR VOUS ASSURER QUE LE PRODUIT N'EST PAS ENDOMMAGÉ PENDANT L'ASSEMBLAGE, NOUS VOUS RECOMMANDONS DE FAIRE APPEL À UNE OU PLUSIEURS AUTRES PERSONNES. EN CAS DE TACHE EXCESSIVE, ESSUYEZ LE FOND DE L'UNITÉ AVANT LE PLACEMENT SUR N'IMPORTE QUELLE SURFACE.



**CUIDADO:** FAVOR DE LEER TODAS LAS INSTRUCCIONES ANTES DE ENSAMBLAR SU PRODUCTO, ESTAS PIEZAS SON PESADAS. PARA PREVENIR HERIDAS PERSONALES Y ASEGURAR QUE SU PRODUCTO NO SEA DAÑADO MIENTRAS ES ENSAMBLADO. SE RECOMIENDA LA ASISTENCIA DE UNA O MÁS PERSONAS.

**WARNING:** PROTECTIVE GLIDE IS PLACED UNDER EACH LEG OF THE FURNITURE TO RESIST SCRATCHES ON FLOOR SURFACE. SOME FLOOR SURFACES CAN BE EXTRA SENSITIVE TO SCRATCHES AND MARKINGS, IF YOU ARE NOT SURE CONSULT WITH YOUR DEALER. AVERTISSEMENT. LES PIÉDS DES MEUBLES SONT MUNIS DE PATINS DESTINÉS À PROTÉGER LE PLANCHER. CERTAINS REVÊTEMENTS DE SOL PEUVENT ÊTRE TRÈS FRAGILES. EN CAS DE DOUTE. CONSULTER LE MARCHAND.

### LIST OF PARTS AND HARDWARE/ LISTE DES PIÈCES ET DU MATÉRIEL/ LISTA DE PIEZAS Y HARDWARE

NO#/ NOMBRE/ NÚMERO	DESCRIPTION/ DESCRIPTION/ DESCRIPCIÓN		QUANTITY/ QUANTITÉ/ CANTIDAD
A	FLAT WASHER/ RONDELLE PLATE/ ARANDELA PLANA	1/4"DIAMETER x 3/4"	 8 PCS
B	LOCK WASHER/ RONDELLE DE BLOCAGE/ ARANDELA DE BLOQUEO	1/4"DIAMETER x 1/2"	 8 PCS
C	BOLT/ BOULON/ TORNILLO	1/4"DIAMETER x 1-1/2"LENGTH	 8 PCS
D	ALLEN KEY/ CLÉ ALLEN/Llave Inglesa ALLEN	3/16"	 1 PC

### LIST OF PARTS AND HARDWARE/ LISTE DES PIÈCES ET DU MATÉRIEL/ LISTA DE PIEZAS Y HARDWARE

NO#/ NOMBRE/ NÚMERO	DESCRIPTION/ DESCRIPTION/ DESCRIPCIÓN		QUANTITY/ QUANTITÉ/ CANTIDAD
1	MIRROR/MIROIR/ESPEJO		 1 PC
2	DRESSER/COMMODOES/APARADORES		 1 PC
3	MIRROR SUPPORT RAIL/RAIL DE SUPPORT DE MIROIR		 2 PCS

**NOTE:**  
ASSEMBLE UNIT ON A SOFT SURFACE.  
ASSEMBLEZ L'UNITÉ SUR UNE SURFACE MOLLE.  
ENSAMBLE LA UNIDAD EN UNA SUPERFICIE PLANA Y SUAVE.

DO NOT TIGHTEN BOLTS UNTIL ALL PARTS AND HARDWARE OF THE UNIT ARE ASSEMBLED.  
NE SERREZ PAS LES BOULONS JUSQU'À CE QUE L'UNITÉ SOIT COMPLÈTEMENT ASSEMBLÉE.  
NO APRIETE LOS TORNILLOS HASTA QUE LA UNIDAD ESTE COMPLETAMENTE ENSAMBLADA.

# ASSEMBLY INSTRUCTIONS INSTRUCTIONS DE MONTAGE INSTRUCCIONES DE MONTAJE

## MIRROR FRAME

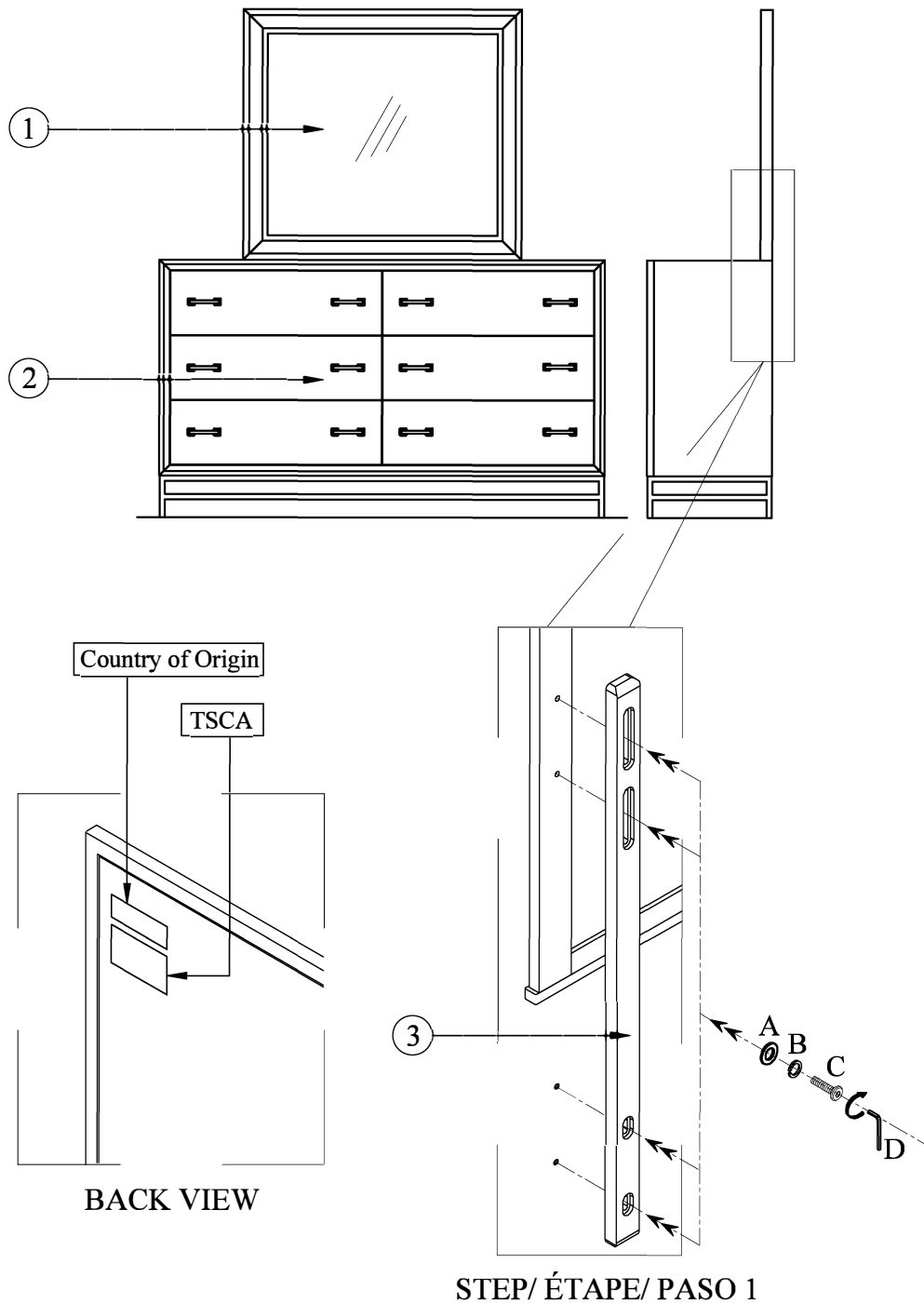

**NOTE:**

THE TABLE OR CASE SHOULD BE LOCKED IN POSITION AND LEVELLED USING A SPIRIT LEVEL. (SPIRIT LEVEL NOT INCLUDED)

LA TABLE OU LE BOÎTIER DOIT ÊTRE VERROUILLÉ EN POSITION ET NIVELÉ À L'AIDE D'UN NIVEAU À BULLE. (NIVEAU À BULLE NON INCLUS)

LA MESA O CAJA DEBE BLOQUEARSE EN SU POSICIÓN Y NIVELARSE CON UN NIVEL DE BURBUJA. (NIVEL DE BURBUJA NO INCLUIDO)



WARNING:  
ONLY USE THE HAND  
TOOLS PROVIDED

# ASSEMBLY INSTRUCTIONS INSTRUCTIONS DE MONTAGE INSTRUCCIONES DE MONTAJE

## QUEEN PANEL BED

**CAUTION:** PLEASE READ ALL INSTRUCTIONS BEFORE STARTING THE ASSEMBLY OF THIS PRODUCT. THESE PIECES ARE HEAVY. IN ORDER TO PREVENT PERSONAL INJURY AND ENSURE THAT THIS PRODUCT IS NOT DAMAGED DURING THE ASSEMBLY PROCESS, IT IS STRONGLY RECOMMENDED TO ENLIST THE ASSISTANCE OF ONE OR MORE PERSONS. IN CASE OF EXCESS STAIN, WIPE THE BOTTOM OF THE UNIT BEFORE PLACING ON ANY SURFACE.

**ATTENTION:** VEUILLEZ LIRE TOUTES LES INSTRUCTIONS AVANT DE COMMENCER L'ASSEMBLAGE DE CE PRODUIT. LES PIECES SONT LOURDES. POUR EVITER TOUTE BLESSURE ET POUR VOUS ASSURER QUE LE PRODUIT N'EST PAS ENDOMMAGE' PENDANT L'ASSEMBLAGE, NOUS VOUS RECOMMANDONS DE FAIRE APPEL A UNE OU PLUSIEURS AUTRES PERSONNES. EN CAS DE TACHE EXCESSIVE, ESSUYEZ LE FOND DE L'UNITE' AVANT LE PLACEMENT SUR N'IMPORTE QUELLE SURFACE.

**CUIDADO:** FAVOR DE LEER TODAS LAS INSTRUCCIONES ANTES DE ENSAMBLAR SU PRODUCTO, ESTAS PIEZAS SON PESADAS. PARA PREVENIR HERIDAS PERSONALES Y ASEGURAR QUE SU PRODUCTO NO SEA DAN ADO MIENTRAS ES ENSAMBLADO. SE RECOMIENDA LA ASISTENCIA DE UNA O MAUS PERSONAS.

**WARNING:** PROTECTIVE GLIDE IS PLACED UNDER EACH LEG OF THE FURNITURE TO RESIST SCRATCHES ON FLOOR SURFACE. SOME FLOOR SURFACES CAN BE EXTRA SENSITIVE TO SCRATCHES AND MARKINGS, IF YOU ARE NOT SURE CONSULT WITH YOUR DEALER.  
AVERTISSEMENT. LES PIEDS DES MEUBLES SONT MUNIS DE PATINS DESTINES A PROTEGER LE PLANCHER. CERTAINS REVETEMENTS DE SOL PEUVENT ETRE TRES FRAGILES. EN CAS DE DOUTE. CONSULTER LE MARCHAND.

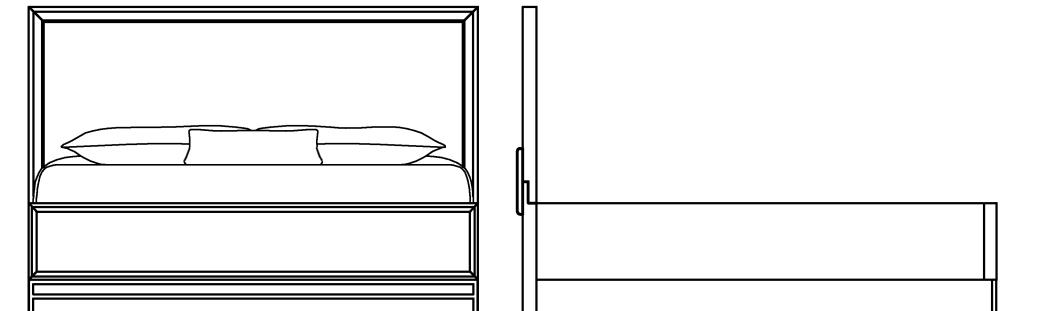









**NOTE:**  
ASSEMBLE UNIT ON A SOFT SURFACE.  
ASSEMBLEZ L'UNITÉ SUR UNE SURFACE MOLLE.  
ENSAMBLE LA UNIDAD EN UNA SUPERFICIE PLANA Y SUAVE.

DO NOT TIGHTEN BOLTS UNTIL ALL PARTS AND HARDWARE OF THE UNIT ARE ASSEMBLED.  
NE SERREZ PAS LES BOULONS JUSQU'À CE QUE L'UNITÉ SOIT COMPLÈTEMENT ASSEMBLÉE.  
NO APRIETE LOS TORNILLOS HASTA QUE LA UNIDAD ESTE COMPLETAMENTE ENSAMBLADA.







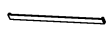

# ASSEMBLY INSTRUCTIONS INSTRUCTIONS DE MONTAGE INSTRUCCIONES DE MONTAJE

## QUEEN PANEL BED

### LIST OF PARTS AND HARDWARE/ LISTE DES PIÈCES ET DU MATÉRIEL/ LISTA DE PIEZAS Y HARDWARE

NO#/ NOMBRE/ NÚMERO	DESCRIPTION/ DESCRIPTION/ DESCRIPCIÓN		QUANTITY/ QUANTITÉ/ CANTIDAD
A	BOLT/ BOULON/ TORNILLO <span style="float: right;">Ø5/ 16"DIAMETER" x 4- 1/ 2"LENGTH</span>		8 PCS
B	CURVED WASHER/RONDELLE COURBE/ ARANDELA CURVA <span style="float: right;">5/ 16"DIAMETER</span>		8 PCS
C	NUT/ÉCROU/NUEZ <span style="float: right;">Ø5/ 16 DIAMETER" x 1/ 2"</span>		8 PCS
D	WRENCH/ CLÉ/LLAVE INGLESA		1 PC
E	FLAT WASHER/ RONDELLE PLATE/ ARANDELA PLANA <span style="float: right;">5/ 16"DIAMETERx 3/ 4"</span>		12 PCS
F	LOCK WASHER/ RONDELLE DE BLOCAGE/ ARANDELA DE BLOQUEO <span style="float: right;">5/ 16"DIAMETER x1/ 2"</span>		12 PCS
G	BOLT/ BOULON/ TORNILLO <span style="float: right;">5/ 16"DIAMETERx 1- 1/ 2"LENGTH</span>		12 PCS
H	ALLEN KEY/ CLÉ ALLEN/LLAVE INGLESA ALLEN <span style="float: right;">3/ 16"</span>		1 PC
I	SCREW/VIS/TORNILLO <span style="float: right;">#8 x 1"LENGTH</span>		8 PCS

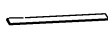
### LIST OF PARTS AND HARDWARE/ LISTE DES PIÈCES ET DU MATÉRIEL/ LISTA DE PIEZAS Y HARDWARE

NO#/ NOMBRE/ NÚMERO	DESCRIPTION/ DESCRIPTION/ DESCRIPCIÓN		QUANTITY/ QUANTITÉ/ CANTIDAD
1	HEADBOARD PANEL/PANNEAU DE TÊTE DE LIT/ PANEL DE CABECERO		1 PC
2	BOTTOM STRETCHER/ÉTIREUSE INFÉRIEURE/ CAMILLA INFERIOR		1 PC
3	LEFT HEADBOARD LEG/JAMBE DE TÊTE DE LIT GAUCHE/ PIERNA IZQUIERDA DEL CABECERO		1 PC
4	RIGHT HEADBOARD LEG/PIED DE TÊTE DE LIT DROIT/ PATAS DEL CABECERO DERECHO		1 PC
5	WOODEN MENDING PLATE/PLAQUE DE RÉPARATION EN BOIS/PLACA DE MADERA PARA MENDER		2 PCS
6	FOOTBOARD/ PIED DE LIT/ ESTRIBO		1 PC
7	SIDE RAIL/RAIL LATÉRAL/CARRIL LATERAL		2 PCS
8	SLAT/LAMELLE/LAMA		4 PCS
9	SLAT SUPPORT LEG/JAMBE DE SUPPORT À LATTES/ PATAS DE SOPORTE DE LAMAS		4 PCS

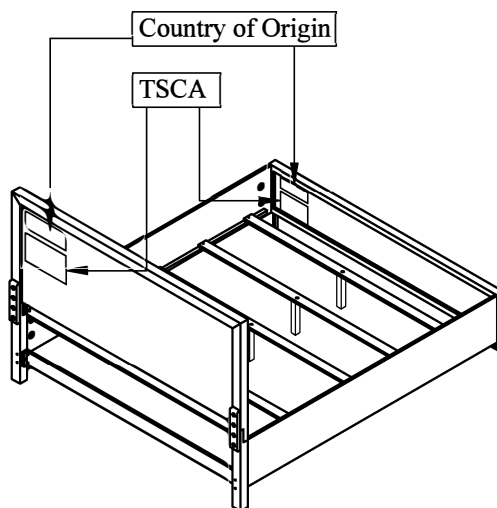

# ASSEMBLY INSTRUCTIONS INSTRUCTIONS DE MONTAGE INSTRUCCIONES DE MONTAJE

QUEEN PANEL BED

STEP/ ÉTAPE/  
PASO 1

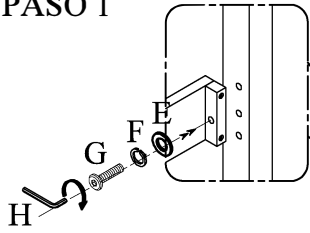

STEP/ ÉTAPE/  
PASO 2

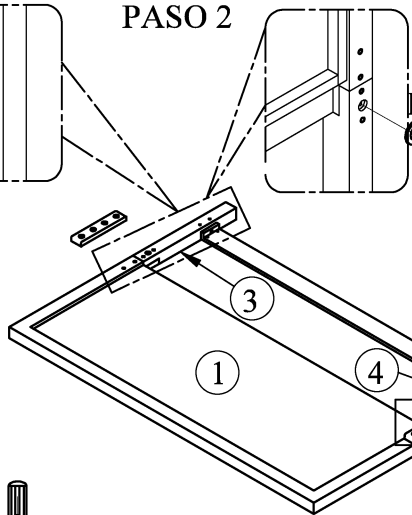

Note:



STEP/ ÉTAPE/  
PASO 3

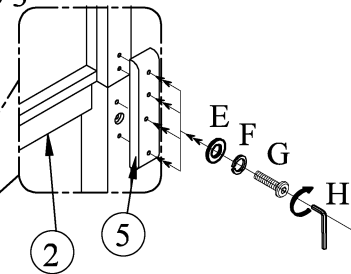

STEP/ ÉTAPE/  
PASO 6

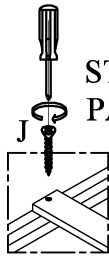

STEP/ ÉTAPE/  
PASO 7

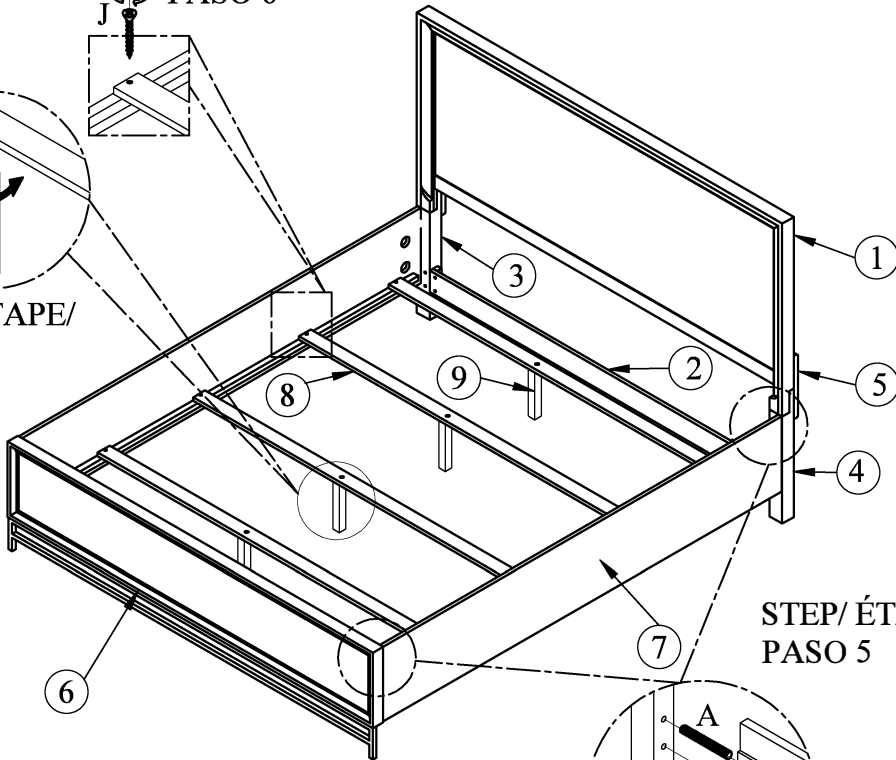
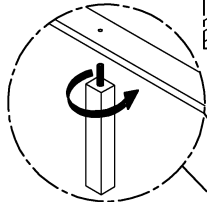

STEP/ ÉTAPE/  
PASO 5

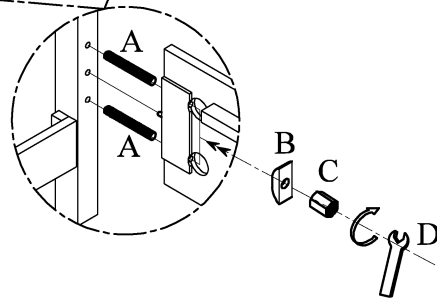

WARNING:  
ONLY USE THE HAND  
TOOLS PROVIDED

# ASSEMBLY INSTRUCTIONS INSTRUCTIONS DE MONTAGE INSTRUCCIONES DE MONTAJE

## QUEEN PANEL BED W/ STORAGE FOOTBOARD

**CAUTION:** PLEASE READ ALL INSTRUCTIONS BEFORE STARTING THE ASSEMBLY OF THIS PRODUCT. THESE PIECES ARE HEAVY. IN ORDER TO PREVENT PERSONAL INJURY AND ENSURE THAT THIS PRODUCT IS NOT DAMAGED DURING THE ASSEMBLY PROCESS, IT IS STRONGLY RECOMMENDED TO ENLIST THE ASSISTANCE OF ONE OR MORE PERSONS. IN CASE OF EXCESS STAIN, WIPE THE BOTTOM OF THE UNIT BEFORE PLACING ON ANY SURFACE.

**ATTENTION:** VEUILLEZ LIRE TOUTES LES INSTRUCTIONS AVANT DE COMMENCER L'ASSEMBLAGE DE CE PRODUIT. LES PIECES SONT LOURDES. POUR EVITER TOUTE BLESSURE ET POUR VOUS ASSURER QUE LE PRODUIT N'EST PAS ENDOMMAGE' PENDANT L'ASSEMBLAGE, NOUS VOUS RECOMMANDONS DE FAIRE APPEL A UNE OU PLUSIEURS AUTRES PERSONNES. EN CAS DE TACHE EXCESSIVE, ESSUYEZ LE FOND DE L'UNITE' AVANT LE PLACEMENT SUR N'IMPORTE QUELLE SURFACE.

**CUIDADO:** FAVOR DE LEER TODAS LAS INSTRUCCIONES ANTES DE ENSAMBLAR SU PRODUCTO, ESTAS PIEZAS SON PESADAS. PARA PREVENIR HERIDAS PERSONALES Y ASEGURAR QUE SU PRODUCTO NO SEA DAN ADO MIENTRAS ES ENSAMBLADO. SE RECOMIENDA LA ASISTENCIA DE UNA O MAUS PERSONAS.

**WARNING:** PROTECTIVE GLIDE IS PLACED UNDER EACH LEG OF THE FURNITURE TO RESIST SCRATCHES ON FLOOR SURFACE. SOME FLOOR SURFACES CAN BE EXTRA SENSITIVE TO SCRATCHES AND MARKINGS, IF YOU ARE NOT SURE CONSULT WITH YOUR DEALER. AVERTISSEMENT. LES PIEDS DES MEUBLES SONT MUNIS DE PATINS DESTINES A PROTEGER LE PLANCHER. CERTAINS REVETEMENTS DE SOL PEUVENT ETRE TRES FRAGILES. EN CAS DE DOUTE. CONSULTER LE MARCHAND.

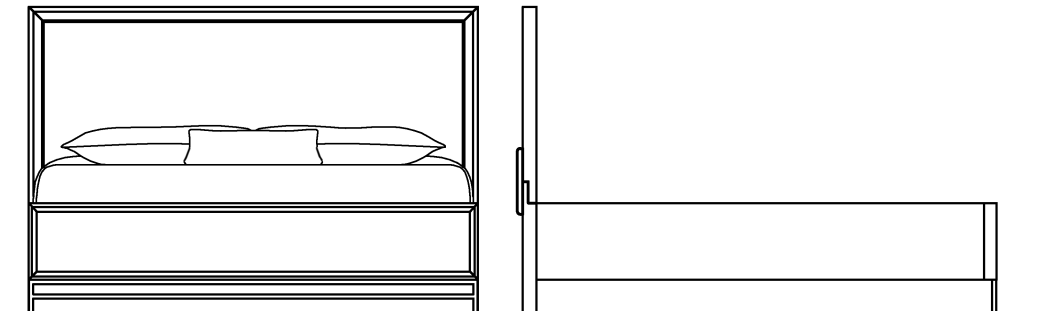









**NOTE:**  
ASSEMBLE UNIT ON A SOFT SURFACE.  
ASSEMBLEZ L'UNITÉ SUR UNE SURFACE MOLLE.  
ENSAMBLE LA UNIDAD EN UNA SUPERFICIE PLANA Y SUAVE.

DO NOT TIGHTEN BOLTS UNTIL ALL PARTS AND HARDWARE OF THE UNIT ARE ASSEMBLED.  
NE SERREZ PAS LES BOULONS JUSQU'À CE QUE L'UNITÉ SOIT COMPLÈTEMENT ASSEMBLÉE.  
NO APRIETE LOS TORNILLOS HASTA QUE LA UNIDAD ESTE COMPLETAMENTE ENSAMBLADA.







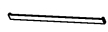

# ASSEMBLY INSTRUCTIONS INSTRUCTIONS DE MONTAGE INSTRUCCIONES DE MONTAJE

## QUEEN PANEL BED W/ STORAGE FOOTBOARD

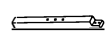
### LIST OF PARTS AND HARDWARE/ LISTE DES PIÈCES ET DU MATÉRIEL/ LISTA DE PIEZAS Y HARDWARE

NO#/ NOMBRE/ NÚMERO	DESCRIPTION/ DESCRIPTION/ DESCRIPCIÓN		QUANTITY/ QUANTITÉ/ CANTIDAD
A	BOLT/ BOULON/ TORNILLO <span style="float: right;">Ø5/ 16"DIAMETER" x 4- 1/ 2"LENGTH</span>		8 PCS
B	CURVED WASHER/RONDELLE COURBE/ ARANDELA CURVA <span style="float: right;">5/ 16"DIAMETER</span>		8 PCS
C	NUT/ÉCROU/NUEZ <span style="float: right;">Ø5/ 16DIAMETER" x 1/ 2"</span>		8 PCS
D	WRENCH/ CLÉ/LLAVE INGLESA		1 PC
E	FLAT WASHER/ RONDELLE PLATE/ ARANDELA PLANA <span style="float: right;">5/ 16"DIAMETERx 3/ 4"</span>		12 PCS
F	LOCK WASHER/ RONDELLE DE BLOCAGE/ ARANDELA DE BLOQUEO <span style="float: right;">5/ 16"DIAMETER x1/ 2"</span>		12 PCS
G	BOLT/ BOULON/ TORNILLO <span style="float: right;">5/ 16"DIAMETERx 1- 1/ 2"LENGTH</span>		12 PCS
H	ALLEN KEY/ CLÉ ALLEN/LLAVE INGLESA ALLEN <span style="float: right;">3/ 16"</span>		1 PC
I	SCREW/VIS/TORNILLO <span style="float: right;">#8 x 1"LENGTH</span>		28 PCS

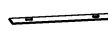
### LIST OF PARTS AND HARDWARE/ LISTE DES PIÈCES ET DU MATÉRIEL/ LISTA DE PIEZAS Y HARDWARE

NO#/ NOMBRE/ NÚMERO	DESCRIPTION/ DESCRIPTION/ DESCRIPCIÓN		QUANTITY/ QUANTITÉ/ CANTIDAD
1	HEADBOARD PANEL/PANNEAU DE TÊTE DE LIT/ PANEL DE CABECERO		1 PC
2	BOTTOM STRETCHER/ÉTIREUSE INFÉRIEURE/ CAMILLA INFERIOR		1 PC
3	LEFT HEADBOARD LEG/JAMBE DE TÊTE DE LIT GAUCHE/ IZQUIERDA DEL CABECERO		1 PC
4	RIGHT HEADBOARD LEG/PIED DE TÊTE DE LIT DROIT/ PATAS DEL CABECERO DERECHO		1 PC
5	WOODEN MENDING PLATE/PLAQUE DE RÉPARATION EN BOIS/PLACA DE MADERA PARA MENDER		2 PCS
6	FOOTBOARD/ PIED DE LIT/ ESTRIBO		1 PC
7	SIDE RAIL/RAIL LATÉRAL/CARRIL LATERAL		2 PCS
8	SLAT ROLL (INCLUDED 14 PCS)/ROULEAU DE FENTE/ ROLLO DE RANURA		14 PCS
9	BOTTOM SLAT/LAME INFÉRIEURE/LLANTA INFERIOR		2 PCS
10	SLAT SUPPORT LEG/JAMBE DE SUPPORT À LATTES/ PATAS DE SOPORTE DE LAMAS		4 PCS
11	STORAGE SUPPORT LEG/JAMBE DE SUPPORT À LATTES/ PATAS DE SOPORTE DE LAMAS		6 PCS

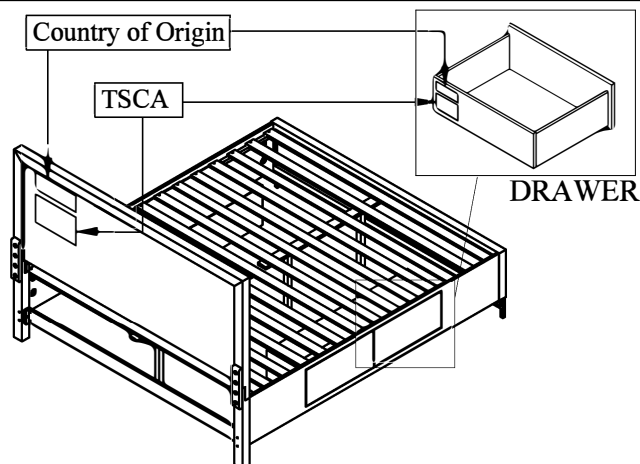

# ASSEMBLY INSTRUCTIONS INSTRUCTIONS DE MONTAGE INSTRUCCIONES DE MONTAJE

QUEEN PANEL BED W/ STORAGE FOOTBOARD

STEP/ ÉTAPE/  
PASO 1

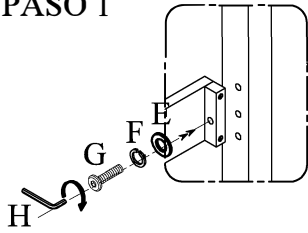

STEP/ ÉTAPE/  
PASO 2

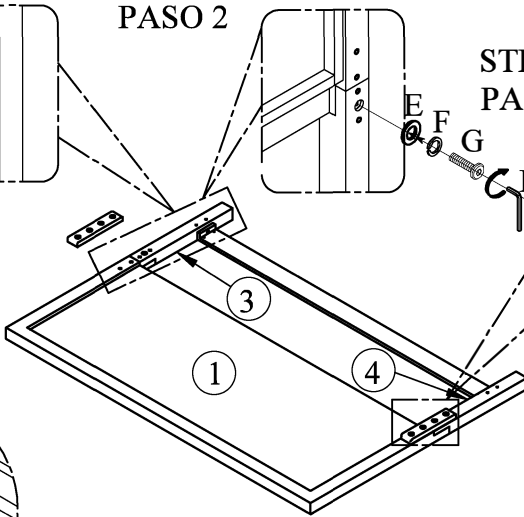

Note:



STEP/ ÉTAPE/  
PASO 3

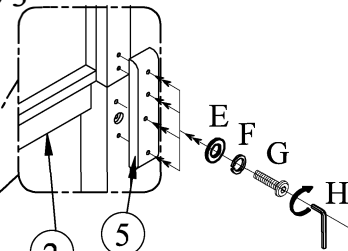

STEP/ ÉTAPE/  
PASO 5

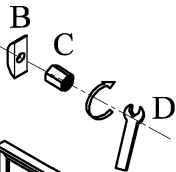
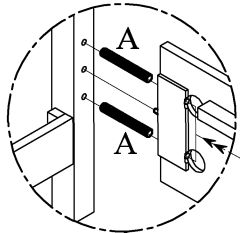

STEP/ ÉTAPE/  
PASO 4

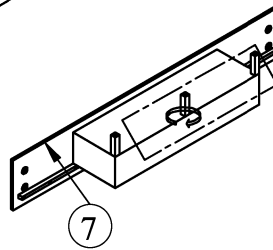

STEP/ ÉTAPE/  
PASO 6

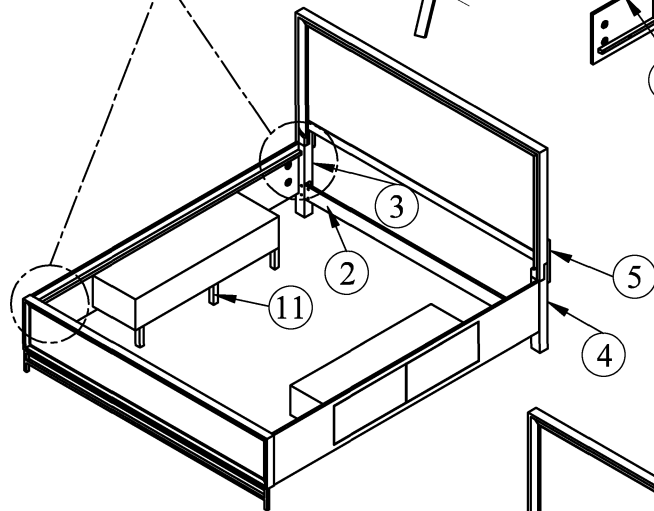
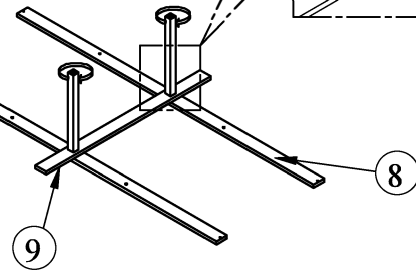
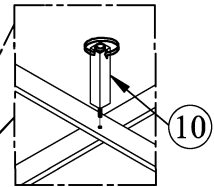

STEP/ ÉTAPE/  
PASO 8

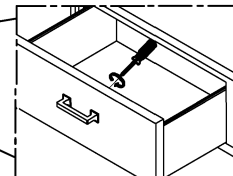

TOP DRAWER

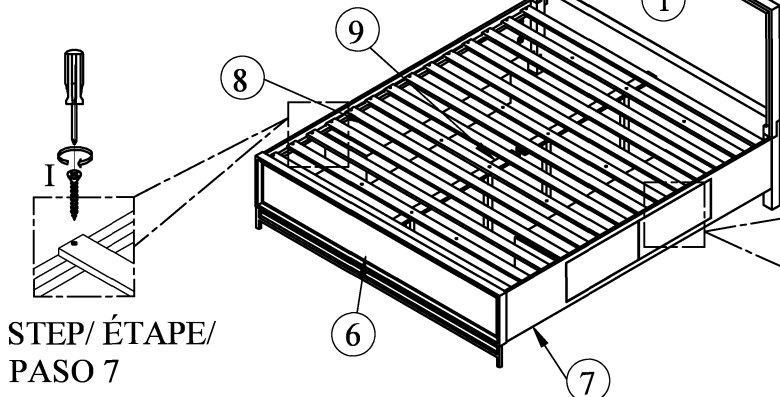

STEP/ ÉTAPE/  
PASO 7

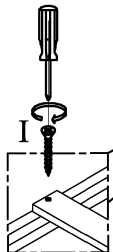

WARNING:  
ONLY USE THE HAND  
TOOLS PROVIDED

# ASSEMBLY INSTRUCTIONS INSTRUCTIONS DE MONTAGE INSTRUCCIONES DE MONTAJE

## KING PANEL BED

**CAUTION:** PLEASE READ ALL INSTRUCTIONS BEFORE STARTING THE ASSEMBLY OF THIS PRODUCT. THESE PIECES ARE HEAVY. IN ORDER TO PREVENT PERSONAL INJURY AND ENSURE THAT THIS PRODUCT IS NOT DAMAGED DURING THE ASSEMBLY PROCESS, IT IS STRONGLY RECOMMENDED TO ENLIST THE ASSISTANCE OF ONE OR MORE PERSONS. IN CASE OF EXCESS STAIN, WIPE THE BOTTOM OF THE UNIT BEFORE PLACING ON ANY SURFACE.

**ATTENTION:** VEUILLEZ LIRE TOUTES LES INSTRUCTIONS AVANT DE COMMENCER L'ASSEMBLAGE DE CE PRODUIT. LES PIECES SONT LOURDES. POUR EVITER TOUTE BLESSURE ET POUR VOUS ASSURER QUE LE PRODUIT N'EST PAS ENDOMMAGE' PENDANT L'ASSEMBLAGE, NOUS VOUS RECOMMANDONS DE FAIRE APPEL A UNE OU PLUSIEURS AUTRES PERSONNES. EN CAS DE TACHE EXCESSIVE, ESSUYEZ LE FOND DE L'UNITE' AVANT LE PLACEMENT SUR N'IMPORTE QUELLE SURFACE.

**CUIDADO:** FAVOR DE LEER TODAS LAS INSTRUCCIONES ANTES DE ENSAMBLAR SU PRODUCTO, ESTAS PIEZAS SON PESADAS. PARA PREVENIR HERIDAS PERSONALES Y ASEGURAR QUE SU PRODUCTO NO SEA DAN ADO MIENTRAS ES ENSAMBLADO. SE RECOMIENDA LA ASISTENCIA DE UNA O MAUS PERSONAS.

**WARNING:** PROTECTIVE GLIDE IS PLACED UNDER EACH LEG OF THE FURNITURE TO RESIST SCRATCHES ON FLOOR SURFACE. SOME FLOOR SURFACES CAN BE EXTRA SENSITIVE TO SCRATCHES AND MARKINGS, IF YOU ARE NOT SURE CONSULT WITH YOUR DEALER.  
AVERTISSEMENT. LES PIEDS DES MEUBLES SONT MUNIS DE PATINS DESTINES A PROTEGER LE PLANCHER. CERTAINS REVETEMENTS DE SOL PEUVENT ETRE TRES FRAGILES. EN CAS DE DOUTE. CONSULTER LE MARCHAND.

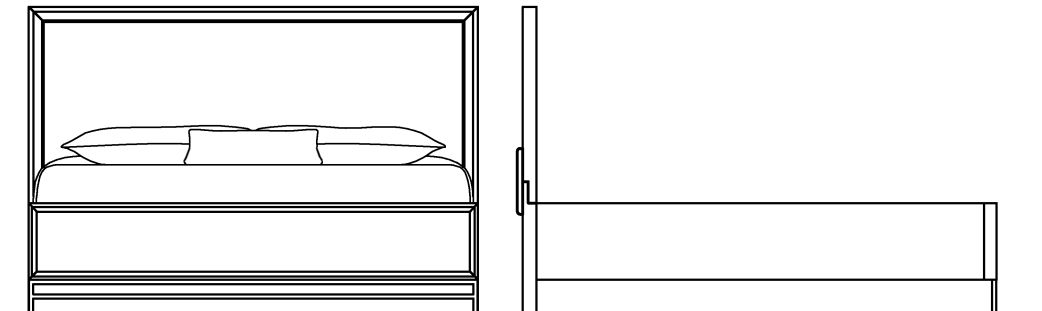









**NOTE:**  
ASSEMBLE UNIT ON A SOFT SURFACE.  
ASSEMBLEZ L'UNITÉ SUR UNE SURFACE MOLLE.  
ENSAMBLE LA UNIDAD EN UNA SUPERFICIE PLANA Y SUAVE.

DO NOT TIGHTEN BOLTS UNTIL ALL PARTS AND HARDWARE OF THE UNIT ARE ASSEMBLED.  
NE SERREZ PAS LES BOULONS JUSQU'À CE QUE L'UNITÉ SOIT COMPLÈTEMENT ASSEMBLÉE.  
NO APRIETE LOS TORNILLOS HASTA QUE LA UNIDAD ESTE COMPLETAMENTE ENSAMBLADA.







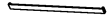

# ASSEMBLY INSTRUCTIONS INSTRUCTIONS DE MONTAGE INSTRUCCIONES DE MONTAJE

## KING PANEL BED

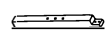
### LIST OF PARTS AND HARDWARE/ LISTE DES PIÈCES ET DU MATÉRIEL/ LISTA DE PIEZAS Y HARDWARE

NO#/ NOMBRE/ NÚMERO	DESCRIPTION/ DESCRIPTION/ DESCRIPCIÓN		QUANTITY/ QUANTITÉ/ CANTIDAD
A	BOLT/ BOULON/ TORNILLO Ø5/ 16"DIAMETER" x 4- 1/ 2"LENGTH		8 PCS
B	CURVED WASHER/RONDELLE COURBE/ ARANDELA CURVA 5/ 16"DIAMETER		8 PCS
C	NUT/ÉCROU/NUEZ Ø5/ 16DIAMETER" x 1/ 2"		8 PCS
D	WRENCH/ CLÉ/LLAVE INGLESA		1 PC
E	FLAT WASHER/RONDELLE PLATE/ ARANDELA PLANA 5/ 16"DIAMETERx 3/ 4"		12 PCS
F	LOCK WASHER/ RONDELLE DE BLOCAGE/ ARANDELA DE BLOQUEO 5/ 16"DIAMETER x1/ 2"		12 PCS
G	BOLT/ BOULON/ TORNILLO 5/ 16"DIAMETERx 1- 1/ 2"LENGTH		12 PCS
H	ALLEN KEY/ CLÉ ALLEN/LLAVE INGLESA ALLEN 3/ 16"		1 PC
I	SCREW/VIS/TORNILLO #8 x 1"LENGTH		8 PCS

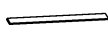
### LIST OF PARTS AND HARDWARE/ LISTE DES PIÈCES ET DU MATÉRIEL/ LISTA DE PIEZAS Y HARDWARE

NO#/ NOMBRE/ NÚMERO	DESCRIPTION/ DESCRIPTION/ DESCRIPCIÓN		QUANTITY/ QUANTITÉ/ CANTIDAD
1	HEADBOARD PANEL/PANNEAU DE TÊTE DE LIT/ PANEL DE CABECERO		1 PC
2	BOTTOM STRETCHER/ÉTIREUSE INFÉRIEURE/ CAMILLA INFERIOR		1 PC
3	LEFT HEADBOARD LEG/JAMBE DE TÊTE DE LIT GAUCHE/ IZQUIERDA DEL CABECERO		1 PC
4	RIGHT HEADBOARD LEG/PIED DE TÊTE DE LIT DROIT/ PATAS DEL CABECERO DERECHO		1 PC
5	WOODEN MENDING PLATE/PLAQUE DE RÉPARATION EN BOIS/ PLACA DE MADERA PARA MENDER		2 PCS
6	FOOTBOARD/ PIED DE LIT/ ESTRIBO		1 PC
7	SIDE RAIL/RAIL LATÉRAL/CARRIL LATERAL		2 PCS
8	SLAT/LAMELLE/LAMA		4 PCS
9	SLAT SUPPORT LEG/JAMBE DE SUPPORT À LATTES/ PATAS DE SOPORTE DE LAMAS		12 PCS

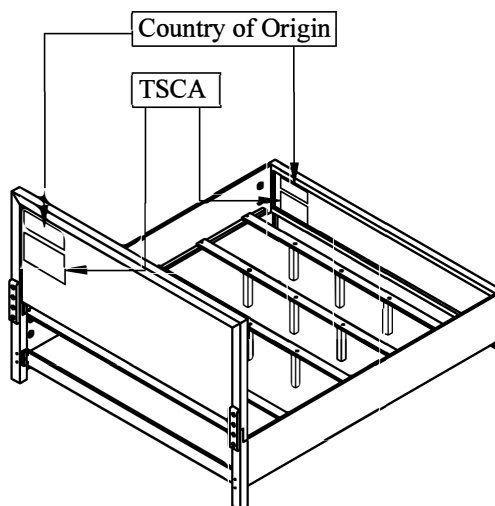

# ASSEMBLY INSTRUCTIONS INSTRUCTIONS DE MONTAGE INSTRUCCIONES DE MONTAJE

## KING PANEL BED

STEP/ ÉTAPE/  
PASO 1

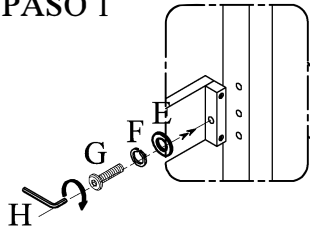

STEP/ ÉTAPE/  
PASO 2

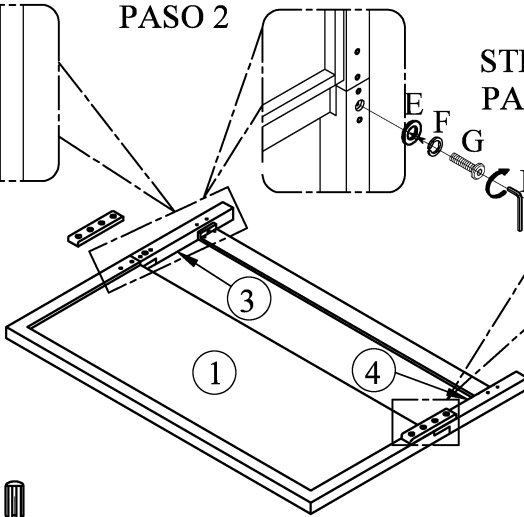

Note:



STEP/ ÉTAPE/  
PASO 3

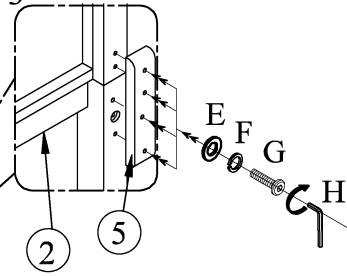

STEP/ ÉTAPE/  
PASO 6

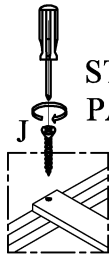

STEP/ ÉTAPE/  
PASO 7

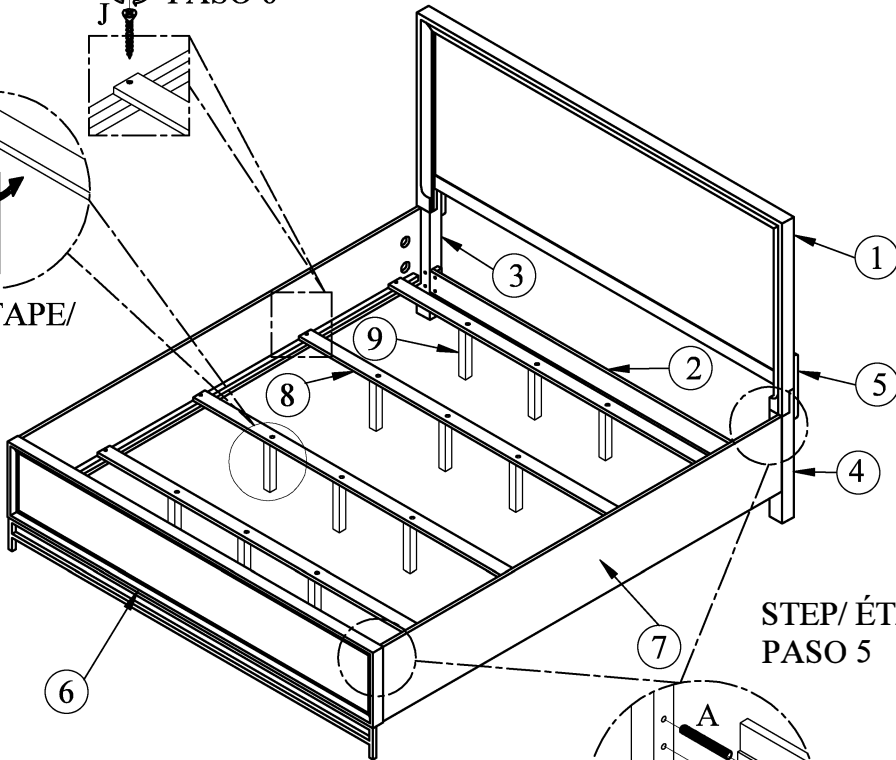
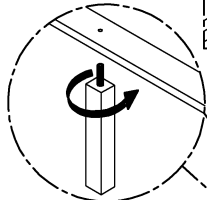

STEP/ ÉTAPE/  
PASO 5

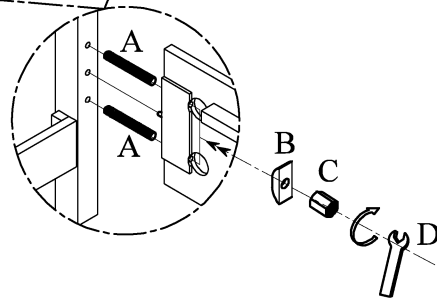

WARNING:  
ONLY USE THE HAND  
TOOLS PROVIDED

# ASSEMBLY INSTRUCTIONS INSTRUCTIONS DE MONTAGE INSTRUCCIONES DE MONTAJE

## KING PANEL BED W/ STORAGE FOOTBOARD

**CAUTION:** PLEASE READ ALL INSTRUCTIONS BEFORE STARTING THE ASSEMBLY OF THIS PRODUCT. THESE PIECES ARE HEAVY. IN ORDER TO PREVENT PERSONAL INJURY AND ENSURE THAT THIS PRODUCT IS NOT DAMAGED DURING THE ASSEMBLY PROCESS, IT IS STRONGLY RECOMMENDED TO ENLIST THE ASSISTANCE OF ONE OR MORE PERSONS. IN CASE OF EXCESS STAIN, WIPE THE BOTTOM OF THE UNIT BEFORE PLACING ON ANY SURFACE.

**ATTENTION:** VEUILLEZ LIRE TOUTES LES INSTRUCTIONS AVANT DE COMMENCER L'ASSEMBLAGE DE CE PRODUIT. LES PIECES SONT LOURDES. POUR EVITER TOUTE BLESSURE ET POUR VOUS ASSURER QUE LE PRODUIT N'EST PAS ENDOMMAGE' PENDANT L'ASSEMBLAGE, NOUS VOUS RECOMMANDONS DE FAIRE APPEL A UNE OU PLUSIEURS AUTRES PERSONNES. EN CAS DE TACHE EXCESSIVE, ESSUYEZ LE FOND DE L'UNITE' AVANT LE PLACEMENT SUR N'IMPORTE QUELLE SURFACE.

**CUIDADO:** FAVOR DE LEER TODAS LAS INSTRUCCIONES ANTES DE ENSAMBLAR SU PRODUCTO, ESTAS PIEZAS SON PESADAS. PARA PREVENIR HERIDAS PERSONALES Y ASEGURAR QUE SU PRODUCTO NO SEA DAN ADO MIENTRAS ES ENSAMBLADO. SE RECOMIENDA LA ASISTENCIA DE UNA O MAUS PERSONAS.

**WARNING:** PROTECTIVE GLIDE IS PLACED UNDER EACH LEG OF THE FURNITURE TO RESIST SCRATCHES ON FLOOR SURFACE. SOME FLOOR SURFACES CAN BE EXTRA SENSITIVE TO SCRATCHES AND MARKINGS, IF YOU ARE NOT SURE CONSULT WITH YOUR DEALER.  
AVERTISSEMENT. LES PIEDS DES MEUBLES SONT MUNIS DE PATINS DESTINES A PROTEGER LE PLANCHER. CERTAINS REVETEMENTS DE SOL PEUVENT ETRE TRES FRAGILES. EN CAS DE DOUTE. CONSULTER LE MARCHAND.

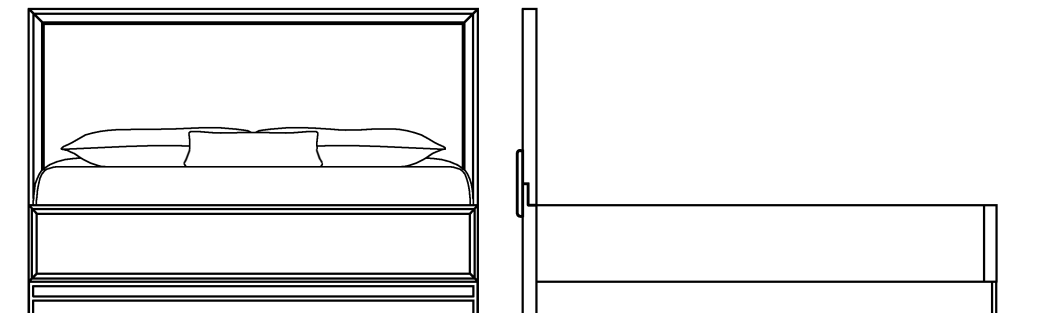









**NOTE:**  
ASSEMBLE UNIT ON A SOFT SURFACE.  
ASSEMBLEZ L'UNITÉ SUR UNE SURFACE MOLLE.  
ENSAMBLE LA UNIDAD EN UNA SUPERFICIE PLANA Y SUAVE.

DO NOT TIGHTEN BOLTS UNTIL ALL PARTS AND HARDWARE OF THE UNIT ARE ASSEMBLED.  
NE SERREZ PAS LES BOULONS JUSQU'À CE QUE L'UNITÉ SOIT COMPLÈTEMENT ASSEMBLÉE.  
NO APRIETE LOS TORNILLOS HASTA QUE LA UNIDAD ESTE COMPLETAMENTE ENSAMBLADA.







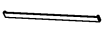
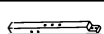
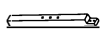

# ASSEMBLY INSTRUCTIONS INSTRUCTIONS DE MONTAGE INSTRUCCIONES DE MONTAJE

## KING PANEL BED W/ STORAGE FOOTBOARD

### LIST OF PARTS AND HARDWARE/ LISTE DES PIÈCES ET DU MATÉRIEL/ LISTA DE PIEZAS Y HARDWARE

NO#/ NOMBRE/ NÚMERO	DESCRIPTION/ DESCRIPTION/ DESCRIPCIÓN		QUANTITY/ QUANTITÉ/ CANTIDAD
A	BOLT/ BOULON/ TORNILLO <span style="float: right;">Ø5/ 16"DIAMETER" x 4- 1/ 2"LENGTH</span>		8 PCS
B	CURVED WASHER/RONDELLE COURBE/ ARANDELA CURVA <span style="float: right;">5/ 16"DIAMETER</span>		8 PCS
C	NUT/ÉCROU/NUEZ <span style="float: right;">Ø5/ 16"DIAMETER" x 1/ 2"</span>		8 PCS
D	WRENCH/ CLÉ/LLAVE INGLESA		1 PC
E	FLAT WASHER/ RONDELLE PLATE/ ARANDELA PLANA <span style="float: right;">5/ 16"DIAMETERx 3/ 4"</span>		12 PCS
F	LOCK WASHER/ RONDELLE DE BLOCAGE/ ARANDELA DE BLOQUEO <span style="float: right;">5/ 16"DIAMETER x1/ 2"</span>		12 PCS
G	BOLT/ BOULON/ TORNILLO <span style="float: right;">5/ 16"DIAMETERx 1- 1/ 2"LENGTH</span>		12 PCS
H	ALLEN KEY/ CLÉ ALLEN/LLAVE INGLESA ALLEN <span style="float: right;">3/ 16"</span>		1 PC
I	SCREW/VIS/TORNILLO <span style="float: right;">#8 x 1"LENGTH</span>		28 PCS

### LIST OF PARTS AND HARDWARE/ LISTE DES PIÈCES ET DU MATÉRIEL/ LISTA DE PIEZAS Y HARDWARE

NO#/ NOMBRE/ NÚMERO	DESCRIPTION/ DESCRIPTION/ DESCRIPCIÓN		QUANTITY/ QUANTITÉ/ CANTIDAD
1	HEADBOARD PANEL/PANNEAU DE TÊTE DE LIT/ PANEL DE CABECERO		1 PC
2	BOTTOM STRETCHER/ÉTIREUSE INFÉRIEURE/ CAMILLA INFERIOR		1 PC
3	LEFT HEADBOARD LEG/JAMBE DE TÊTE DE LIT GAUCHE/ IZQUIERDA DEL CABECERO		1 PC
4	RIGHT HEADBOARD LEG/PIED DE TÊTE DE LIT DROIT/ PATAS DEL CABECERO DERECHO		1 PC
5	WOODEN MENDING PLATE/PLAQUE DE RÉPARATION EN BOIS/PLACA DE MADERA PARA MENDER		2 PCS
6	FOOTBOARD/ PIED DE LIT/ ESTRIBO		1 PC
7	SIDE RAIL/RAIL LATÉRAL/CARRIL LATERAL		2 PCS
8	SLAT ROLL (INCLUDED 14 PCS)/ROULEAU DE FENTE/ ROLLO DE RANURA		14 PCS
9	BOTTOM SLAT/LAME INFÉRIEURE/LLANTA INFERIOR		2 PCS
10	SLAT SUPPORT LEG/JAMBE DE SUPPORT À LATTES/ PATAS DE SOPORTE DE LAMAS		4 PCS
11	STORAGE SUPPORT LEG/JAMBE DE SUPPORT À LATTES/ PATAS DE SOPORTE DE LAMAS		6 PCS

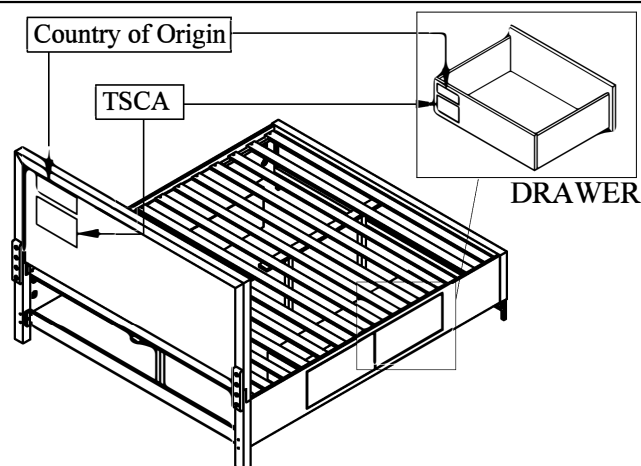

# ASSEMBLY INSTRUCTIONS INSTRUCTIONS DE MONTAGE INSTRUCCIONES DE MONTAJE

KING PANEL BED W/ STORAGE FOOTBOARD

STEP/ ÉTAPE/  
PASO 1

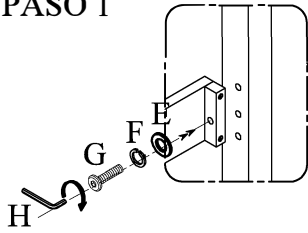

STEP/ ÉTAPE/  
PASO 2

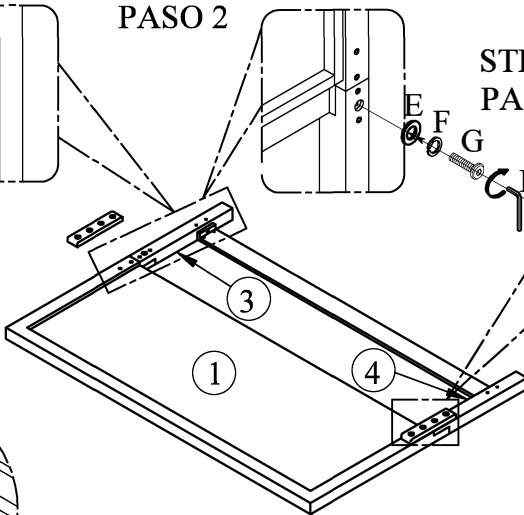

Note:

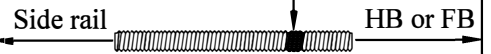

STEP/ ÉTAPE/  
PASO 3

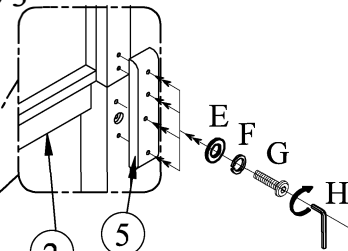

STEP/ ÉTAPE/  
PASO 5

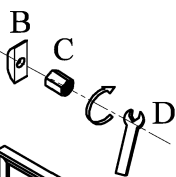
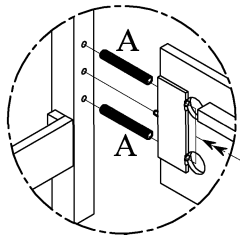

STEP/ ÉTAPE/  
PASO 4

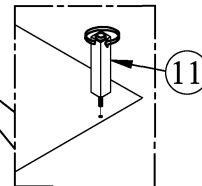
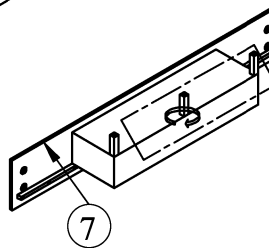

STEP/ ÉTAPE/  
PASO 6

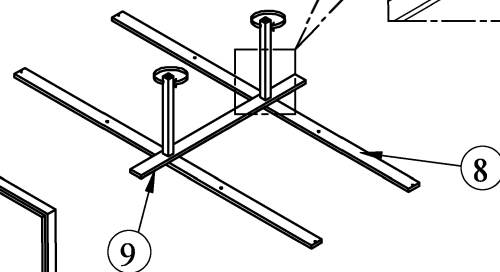
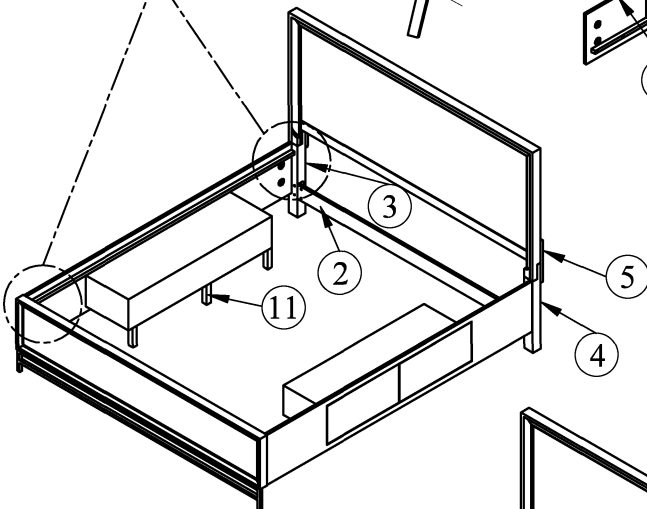
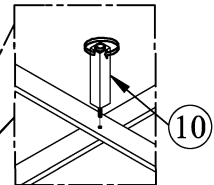

STEP/ ÉTAPE/  
PASO 8

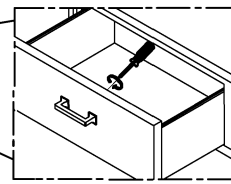

STEP/ ÉTAPE/  
PASO 7

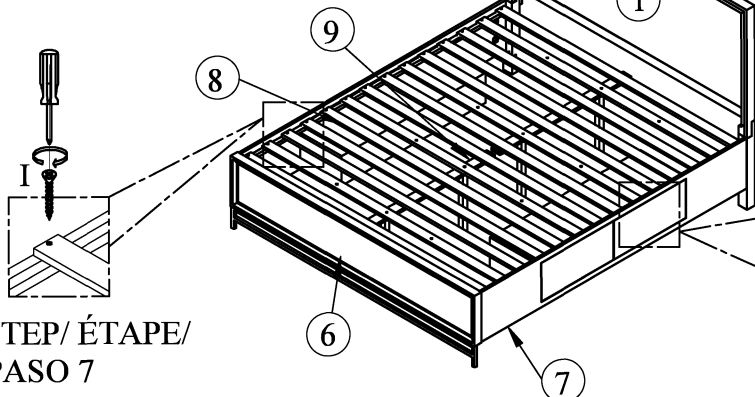

TOP DRAWER



WARNING:  
ONLY USE THE HAND  
TOOLS PROVIDED

# ASSEMBLY INSTRUCTIONS INSTRUCTIONS DE MONTAGE INSTRUCCIONES DE MONTAJE

## CAL. KING PANEL BED

**CAUTION:** PLEASE READ ALL INSTRUCTIONS BEFORE STARTING THE ASSEMBLY OF THIS PRODUCT. THESE PIECES ARE HEAVY. IN ORDER TO PREVENT PERSONAL INJURY AND ENSURE THAT THIS PRODUCT IS NOT DAMAGED DURING THE ASSEMBLY PROCESS, IT IS STRONGLY RECOMMENDED TO ENLIST THE ASSISTANCE OF ONE OR MORE PERSONS. IN CASE OF EXCESS STAIN, WIPE THE BOTTOM OF THE UNIT BEFORE PLACING ON ANY SURFACE.

**ATTENTION:** VEUILLEZ LIRE TOUTES LES INSTRUCTIONS AVANT DE COMMENCER L'ASSEMBLAGE DE CE PRODUIT. LES PIECES SONT LOURDES. POUR EVITER TOUTE BLESSURE ET POUR VOUS ASSURER QUE LE PRODUIT N'EST PAS ENDOMMAGE' PENDANT L'ASSEMBLAGE, NOUS VOUS RECOMMANDONS DE FAIRE APPEL A UNE OU PLUSIEURS AUTRES PERSONNES. EN CAS DE TACHE EXCESSIVE, ESSUYEZ LE FOND DE L'UNITE' AVANT LE PLACEMENT SUR N'IMPORTE QUELLE SURFACE.

**CUIDADO:** FAVOR DE LEER TODAS LAS INSTRUCCIONES ANTES DE ENSAMBLAR SU PRODUCTO, ESTAS PIEZAS SON PESADAS. PARA PREVENIR HERIDAS PERSONALES Y ASEGURAR QUE SU PRODUCTO NO SEA DAN ADO MIENTRAS ES ENSAMBLADO. SE RECOMIENDA LA ASISTENCIA DE UNA O MAUS PERSONAS.

**WARNING:** PROTECTIVE GLIDE IS PLACED UNDER EACH LEG OF THE FURNITURE TO RESIST SCRATCHES ON FLOOR SURFACE. SOME FLOOR SURFACES CAN BE EXTRA SENSITIVE TO SCRATCHES AND MARKINGS, IF YOU ARE NOT SURE CONSULT WITH YOUR DEALER.  
AVERTISSEMENT. LES PIEDS DES MEUBLES SONT MUNIS DE PATINS DESTINES A PROTEGER LE PLANCHER. CERTAINS REVETEMENTS DE SOL PEUVENT ETRE TRES FRAGILES. EN CAS DE DOUTE. CONSULTER LE MARCHAND.

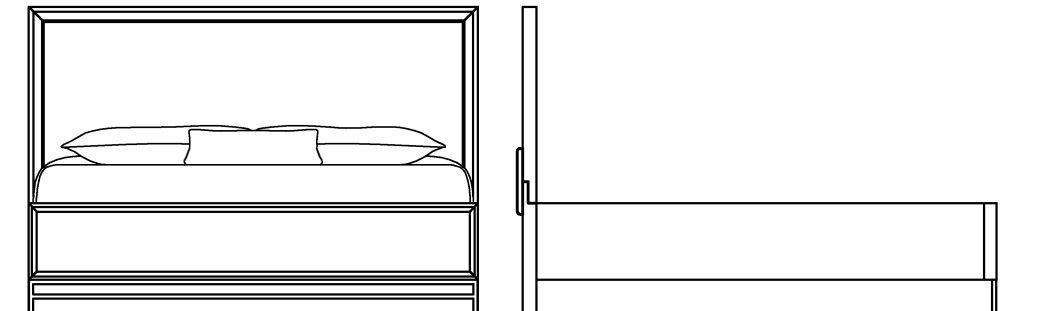













**NOTE:**  
ASSEMBLE UNIT ON A SOFT SURFACE.  
ASSEMBLEZ L'UNITÉ SUR UNE SURFACE MOLLE.  
ENSAMBLE LA UNIDAD EN UNA SUPERFICIE PLANA Y SUAVE.

DO NOT TIGHTEN BOLTS UNTIL ALL PARTS AND HARDWARE OF THE UNIT ARE ASSEMBLED.  
NE SERREZ PAS LES BOULONS JUSQU'À CE QUE L'UNITÉ SOIT COMPLÈTEMENT ASSEMBLÉE.  
NO APRIETE LOS TORNILLOS HASTA QUE LA UNIDAD ESTE COMPLETAMENTE ENSAMBLADA.







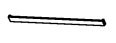

# ASSEMBLY INSTRUCTIONS INSTRUCTIONS DE MONTAGE INSTRUCCIONES DE MONTAJE

## CAL. KING PANEL BED

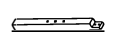
### LIST OF PARTS AND HARDWARE/ LISTE DES PIÈCES ET DU MATÉRIEL/ LISTA DE PIEZAS Y HARDWARE

NO#/ NOMBRE/ NÚMERO	DESCRIPTION/ DESCRIPTION/ DESCRIPCIÓN		QUANTITY/ QUANTITÉ/ CANTIDAD
A	BOLT/ BOULON/ TORNILLO <span style="float: right;">Ø5/16"DIAMETER" x 4-1/2"LENGTH</span>		8 PCS
B	CURVED WASHER/RONDELLE COURBE/ ARANDELA CURVA <span style="float: right;">5/16"DIAMETER</span>		8 PCS
C	NUT/ÉCROU/NUEZ <span style="float: right;">Ø5/16 DIAMETER" x 1/2"</span>		8 PCS
D	WRENCH/ CLÉ/LLAVE INGLESA		1 PC
E	FLAT WASHER/ RONDELLE PLATE/ ARANDELA PLANA <span style="float: right;">5/16"DIAMETER x 3/4"</span>		12 PCS
F	LOCK WASHER/ RONDELLE DE BLOCAGE/ ARANDELA DE BLOQUEO <span style="float: right;">5/16"DIAMETER x 1/2"</span>		12 PCS
G	BOLT/ BOULON/ TORNILLO <span style="float: right;">5/16"DIAMETER x 1-1/2"LENGTH</span>		12 PCS
H	BOLT/ BOULON/ TORNILLO <span style="float: right;">1/4"DIAMETER x 2-3/8"LENGTH</span>		10 PCS
I	ALLEN KEY/ CLÉ ALLEN/LLAVE INGLESA ALLEN <span style="float: right;">3/16"</span>		1 PC
J	SCREW/VIS/TORNILLO <span style="float: right;">#8 x 1"LENGTH</span>		8 PCS
K	FLAT WASHER/ RONDELLE PLATE/ ARANDELA PLANA <span style="float: right;">1/4"DIAMETER x 1/2"</span>		10 PCS
L	LOCK WASHER/ RONDELLE DE BLOCAGE/ ARANDELA DE BLOQUEO <span style="float: right;">1/4"DIAMETER x 1/2"</span>		10 PCS

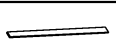
### LIST OF PARTS AND HARDWARE/ LISTE DES PIÈCES ET DU MATÉRIEL/ LISTA DE PIEZAS Y HARDWARE

NO#/ NOMBRE/ NÚMERO	DESCRIPTION/ DESCRIPTION/ DESCRIPCIÓN		QUANTITY/ QUANTITÉ/ CANTIDAD
1	HEADBOARD PANEL/PANNEAU DE TÊTE DE LIT/ PANEL DE CABECERO		1 PC
2	BOTTOM STRETCHER/ÉTIREUSE INFÉRIEURE/ CAMILLA INFERIOR		1 PC
3	LEFT HEADBOARD LEG/JAMBE DE TÊTE DE LIT GAUCHE/ IZQUIERDA DEL CABECERO		1 PC
4	RIGHT HEADBOARD LEG/PIED DE TÊTE DE LIT DROIT/ PATAS DEL CABECERO DERECHO		1 PC
5	WOODEN MENDING PLATE/PLAQUE DE RÉPARATION EN BOIS/PLACA DE MADERA PARA MENDER		2 PCS
6	FOOTBOARD/PIED DE LIT/ ESTRIBO		1 PC
7	SIDE RAIL/RAIL LATÉRAL/CARRIL LATERAL		2 PCS
8	SIDE RAIL CLEATS/RAILS LATÉRAUX/ TAPAS DE RIEL LATERAL		2 PCS
9	SLAT/LAMELLE/LAMA		4 PCS
10	SLAT SUPPORT LEG/JAMBE DE SUPPORT À LATTES/ PATAS DE SOPORTE DE LAMAS		12 PCS

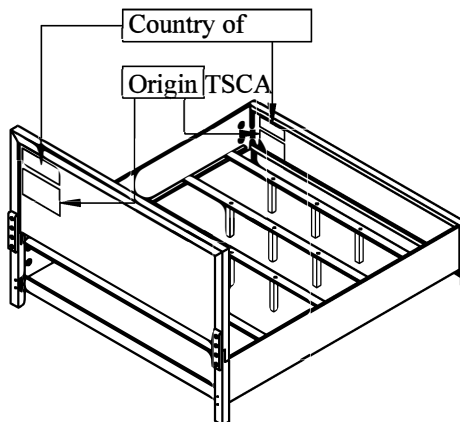

WARNING:  
ONLY USE THE HAND  
TOOLS PROVIDED

# ASSEMBLY INSTRUCTIONS INSTRUCTIONS DE MONTAGE INSTRUCCIONES DE MONTAJE

## CAL. KING PANEL BED

STEP/ ÉTAPE/  
PASO 1

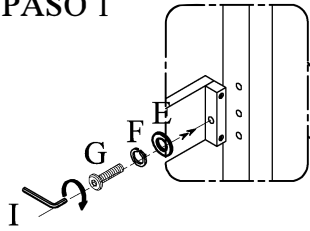

STEP/ ÉTAPE/  
PASO 2

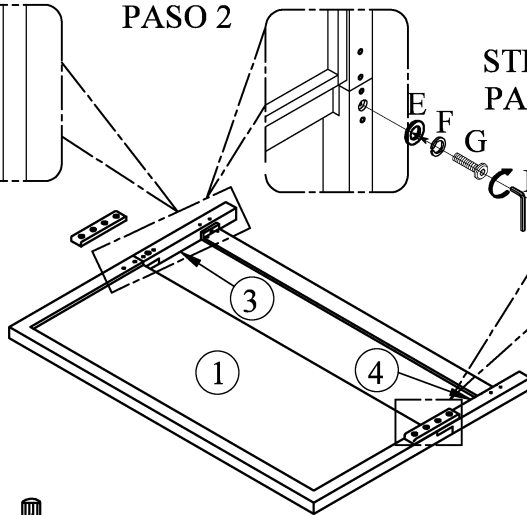

STEP/ ÉTAPE/  
PASO 3

Note: Side rail      Mark      HB or FB

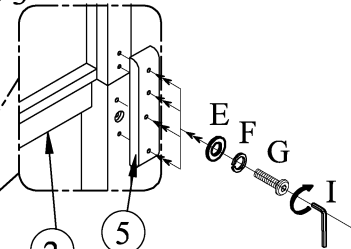

STEP/ ÉTAPE/  
PASO 6

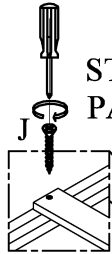

STEP/ ÉTAPE/  
PASO 4

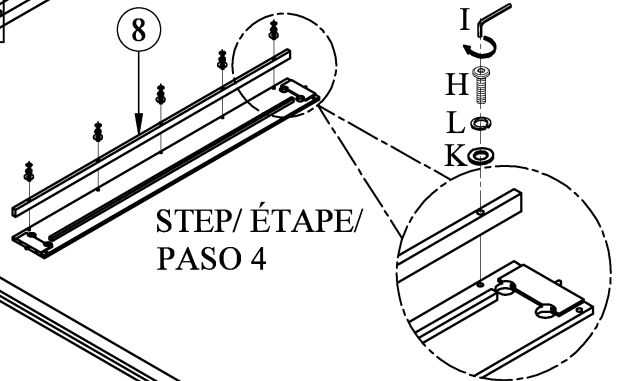

STEP/ ÉTAPE/  
PASO 7

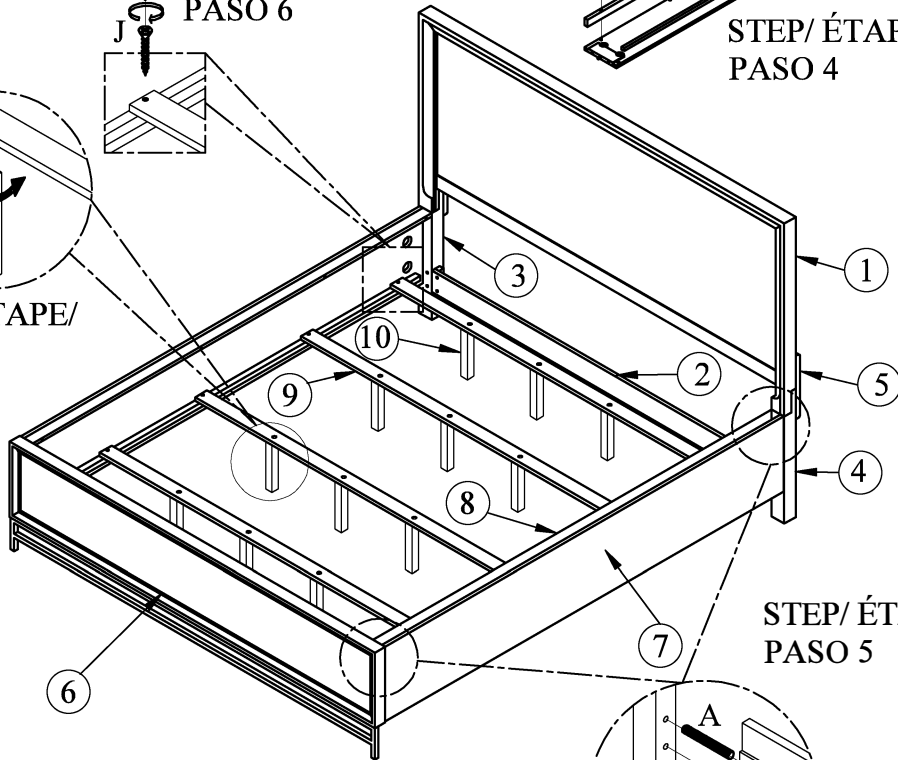
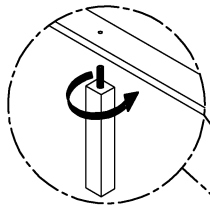

STEP/ ÉTAPE/  
PASO 5

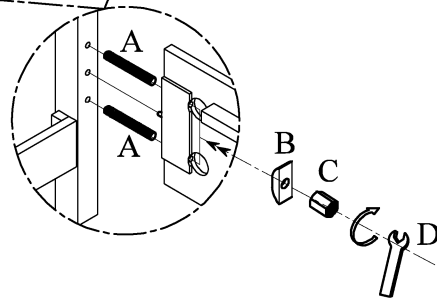













WARNING:  
ONLY USE THE HAND  
TOOLS PROVIDED











# ASSEMBLY INSTRUCTIONS INSTRUCTIONS DE MONTAGE INSTRUCCIONES DE MONTAJE

## CAL KING STORAGE BED

### LIST OF PARTS AND HARDWARE/ LISTE DES PIÈCES ET DU MATÉRIEL/ LISTA DE PIEZAS Y HARDWARE

NO#/ NOMBRE/ NÚMERO	DESCRIPTION/ DESCRIPTION/ DESCRIPCIÓN		QUANTITY/ QUANTITÉ/ CANTIDAD
A	BOLT/ BOULON/ TORNILLO <span style="float: right;">Ø5/16"DIAMETER" x 4-1/2"LENGTH</span>		8 PCS
B	CURVED WASHER/RONDELLE COURBE/ ARANDELA CURVA <span style="float: right;">5/16"DIAMETER</span>		8 PCS
C	NUT/ÉCROU/NUEZ <span style="float: right;">Ø5/16 DIAMETER" x 1/2"</span>		8 PCS
D	WRENCH/ CLÉ/LLAVE INGLESА		1 PC
E	FLAT WASHER/ RONDELLE PLATE/ ARANDELA PLANA <span style="float: right;">5/16"DIAMETER x 3/4"</span>		12 PCS
F	LOCK WASHER/ RONDELLE DE BLOCAGE/ ARANDELA DE BLOQUEO <span style="float: right;">5/16"DIAMETER x 1/2"</span>		12 PCS
G	BOLT/ BOULON/ TORNILLO <span style="float: right;">5/16"DIAMETER x 1-1/2"LENGTH</span>		12 PCS
H	BOLT/ BOULON/ TORNILLO <span style="float: right;">1/4"DIAMETER x 2-3/8"LENGTH</span>		10 PCS
I	ALLEN KEY/ CLÉ ALLEN/LLAVE INGLESА ALLEN <span style="float: right;">3/16"</span>		1 PC
J	SCREW/VIS/TORNILLO <span style="float: right;">#8 x 1"LENGTH</span>		28 PCS
K	FLAT WASHER/ RONDELLE PLATE/ ARANDELA PLANA <span style="float: right;">1/4"DIAMETER x 1/2"</span>		10 PCS
L	LOCK WASHER/ RONDELLE DE BLOCAGE/ ARANDELA DE BLOQUEO <span style="float: right;">1/4"DIAMETER x 1/2"</span>		10 PCS

### LIST OF PARTS AND HARDWARE/ LISTE DES PIÈCES ET DU MATÉRIEL/ LISTA DE PIEZAS Y HARDWARE

NO#/ NOMBRE/ NÚMERO	DESCRIPTION/ DESCRIPTION/ DESCRIPCIÓN		QUANTITY/ QUANTITÉ/ CANTIDAD
1	HEADBOARD PANEL/PANNEAU DE TÊTE DE LIT/ PANEL DE CABECERO		1 PC
2	BOTTOM STRETCHER/ÉTIREUSE INFÉRIEURE/ CAMILLA INFERIOR		1 PC
3	LEFT HEADBOARD LEG/JAMBE DE TÊTE DE LIT GAUCHE/ PIERNA IZQUIERDA DEL CABECERO		1 PC
4	RIGHT HEADBOARD LEG/PIED DE TÊTE DE LIT DROIT/ PATAS DEL CABECERO DERECHO		1 PC
5	WOODEN MENDING PLATE/PLAQUE DE RÉPARATION EN BOIS/ MADERA PARA MENDER		2 PCS
6	FOOTBOARD/ PIED DE LIT/ ESTRIBO		1 PC
7	SIDE RAIL/RAIL LATÉRAL/CARRIL LATERAL		2 PCS
8	SLAT ROLL (INCLUDED 14 PCS)/ROULEAU DE FENTE/ ROLLO DE RANURA		14 PCS
9	BOTTOM SLAT/LAME INFÉRIEURE/LLANTA INFERIOR		2 PCS
10	SLAT SUPPORT LEG/JAMBE DE SUPPORT À LATTES/ PATAS DE SOPORTE DE LAMAS		4 PCS
11	STORAGE SUPPORT LEG/JAMBE DE SUPPORT À LATTES/ PATAS DE SOPORTE DE LAMAS		6 PCS

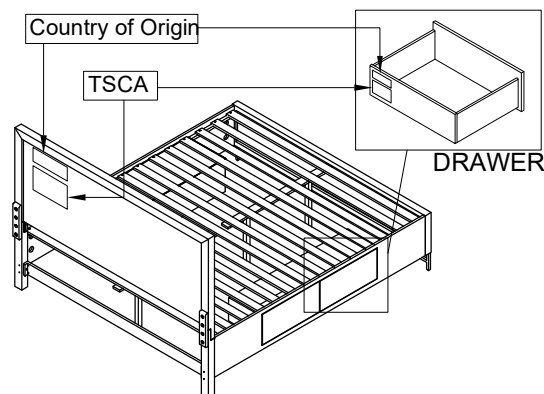

# ASSEMBLY INSTRUCTIONS INSTRUCTIONS DE MONTAGE INSTRUCCIONES DE MONTAJE

## CAL KING STORAGE BED

**CAUTION:** PLEASE READ ALL INSTRUCTIONS BEFORE STARTING THE ASSEMBLY OF THIS PRODUCT. THESE PIECES ARE HEAVY. IN ORDER TO PREVENT PERSONAL INJURY AND ENSURE THAT THIS PRODUCT IS NOT DAMAGED DURING THE ASSEMBLY PROCESS, IT IS STRONGLY RECOMMENDED TO ENLIST THE ASSISTANCE OF ONE OR MORE PERSONS. IN CASE OF EXCESS STAIN, WIPE THE BOTTOM OF THE UNIT BEFORE PLACING ON ANY SURFACE.

**ATTENTION:** VEUILLEZ LIRE TOUTES LES INSTRUCTIONS AVANT DE COMMENCER L'ASSEMBLAGE DE CE PRODUIT. LES PIECES SONT LOURDES. POUR EVITER TOUTE BLESSURE ET POUR VOUS ASSURER QUE LE PRODUIT N'EST PAS ENDOMMAGE' PENDANT L'ASSEMBLAGE, NOUS VOUS RECOMMANDONS DE FAIRE APPEL A UNE OU PLUSIEURS AUTRES PERSONNES. EN CAS DE TACHE EXCESSIVE, ESSUYEZ LE FOND DE L'UNITE' AVANT LE PLACEMENT SUR N'IMPORTE QUELLE SURFACE.

**CUIDADO:** FAVOR DE LEER TODAS LAS INSTRUCCIONES ANTES DE ENSAMBLAR SU PRODUCTO, ESTAS. PIEZAS SON PESADAS. PARA PREVENIR HERIDAS PERSONALES Y ASEGURAR QUE SU PRODUCTO NO SEA DAN ADO MIENTRAS ES ENSAMBLADO. SE RECOMIENDA LA ASISTENCIA DE UNA O MAUS PERSONAS.

**WARNING:** PROTECTIVE GLIDE IS PLACED UNDER EACH LEG OF THE FURNITURE TO RESIST SCRATCHES ON FLOOR SURFACE. SOME FLOOR SURFACES CAN BE EXTRA SENSITIVE TO SCRATCHES AND MARKINGS, IF YOU ARE NOT SURE CONSULT WITH YOUR DEALER. AVERTISSEMENT. LES PIEDS DES MEUBLES SONT MUNIS DE PATINS DESTINES A PROTEGER LE PLANCHER. CERTAINS REVETEMENTS DE SOL PEUVENT ETRE TRES FRAGILES. EN CAS DE DOUTE. CONSULTER LE MARCHAND.

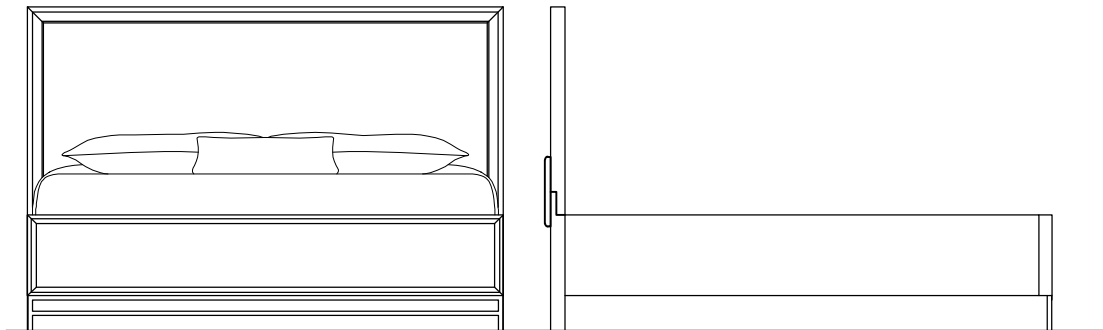

**NOTE:**  
ASSEMBLE UNIT ON A SOFT SURFACE.  
ASSEMBLEZ L'UNITÉ SUR UNE SURFACE MOLLE.  
ENSAMBLE LA UNIDAD EN UNA SUPERFICIE PLANA Y SUAVE.

DO NOT TIGHTEN BOLTS UNTIL ALL PARTS AND HARDWARE OF THE UNIT ARE ASSEMBLED.  
NE SERREZ PAS LES BOULONS JUSQU'À CE QUE L'UNITÉ SOIT COMPLÈTEMENT ASSEMBLÉE.  
NO APRIETE LOS TORNILLOS HASTA QUE LA UNIDAD ESTE COMPLETAMENTE ENSAMBLADA.

# ASSEMBLY INSTRUCTIONS INSTRUCTIONS DE MONTAGE INSTRUCCIONES DE MONTAJE

CAL KING STORAGE BED

STEP/ ÉTAPE/  
PASO 1

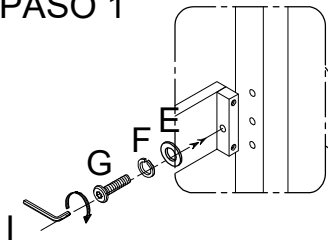

STEP/ ÉTAPE/  
PASO 2

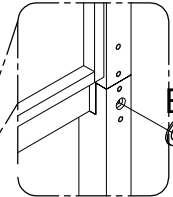

Note:

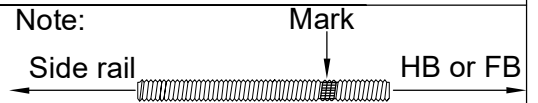

STEP/ ÉTAPE/  
PASO 3

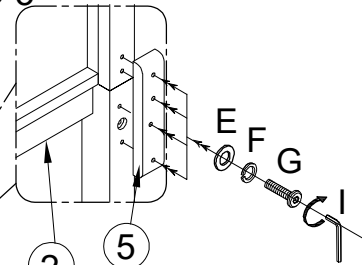

STEP/ ÉTAPE/  
PASO 5

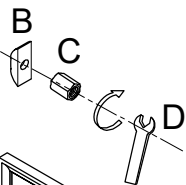
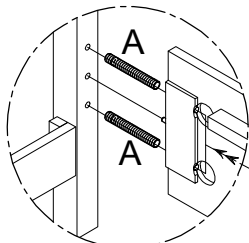

STEP/ ÉTAPE/  
PASO 4

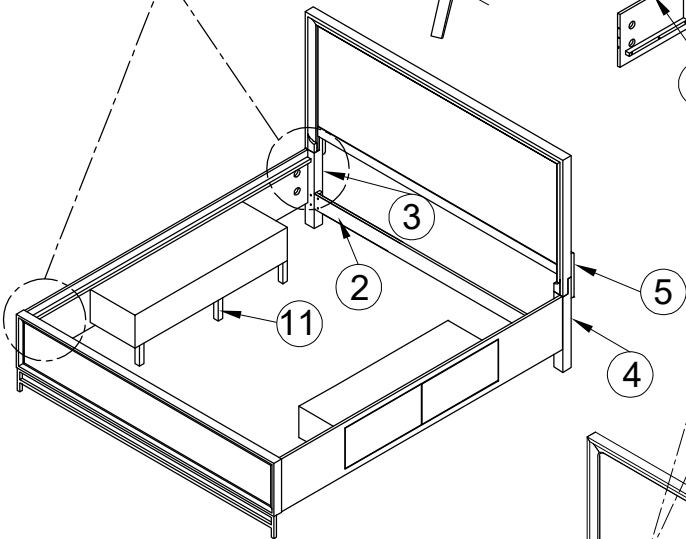
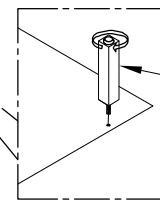
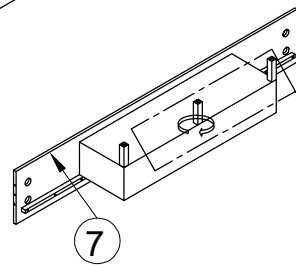

STEP/ ÉTAPE/  
PASO 6

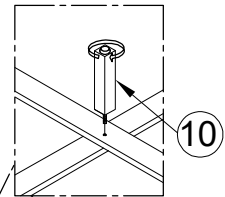

STEP/ ÉTAPE/  
PASO 9

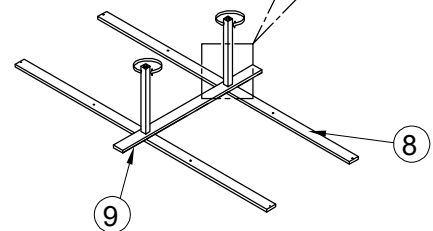
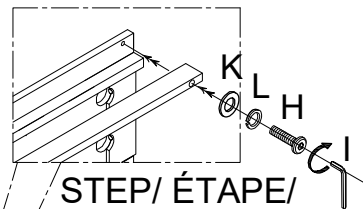

STEP/ ÉTAPE/  
PASO 8

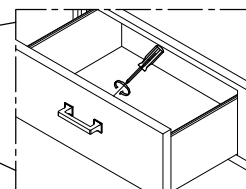

TOP DRAWER

STEP/ ÉTAPE/  
PASO 7

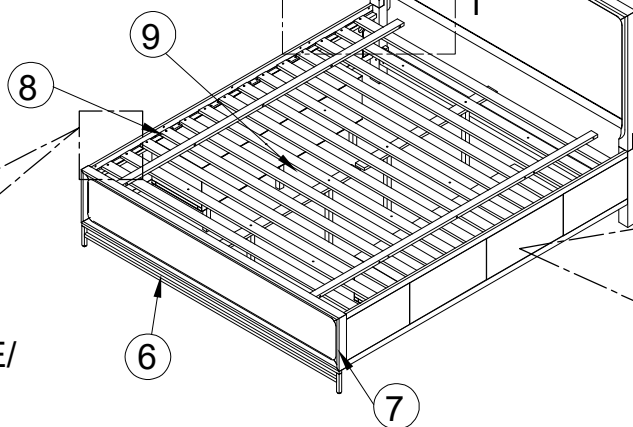
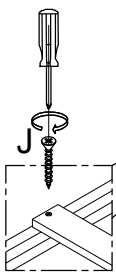

WARNING:  
ONLY USE THE HAND  
TOOLS PROVIDED

# ASSEMBLY INSTRUCTIONS INSTRUCTIONS DE MONTAGE INSTRUCCIONES DE MONTAJE







## QUEEN UPHOLSTERED FOOTBOARD





**CAUTION:** PLEASE READ ALL INSTRUCTIONS BEFORE STARTING THE ASSEMBLY OF THIS PRODUCT. THESE PIECES ARE HEAVY. IN ORDER TO PREVENT PERSONAL INJURY AND ENSURE THAT THIS PRODUCT IS NOT DAMAGED DURING THE ASSEMBLY PROCESS, IT IS STRONGLY RECOMMENDED TO ENLIST THE ASSISTANCE OF ONE OR MORE PERSONS. IN CASE OF EXCESS STAIN, WIPE THE BOTTOM OF THE UNIT BEFORE PLACING ON ANY SURFACE.

**ATTENTION:** VEUILLEZ LIRE TOUTES LES INSTRUCTIONS AVANT DE COMMENCER L'ASSEMBLAGE DE CE PRODUIT. LES PIECES SONT LOURDES. POUR EVITER TOUTE BLESSURE ET POUR VOUS ASSURER QUE LE PRODUIT N'EST PAS ENDOMMAGE' PENDANT L'ASSEMBLAGE, NOUS VOUS RECOMMANDONS DE FAIRE APPEL A UNE OU PLUSIEURS AUTRES PERSONNES. EN CAS DE TACHE EXCESSIVE, ESSUYEZ LE FOND DE L'UNITE' AVANT LE PLACEMENT SUR N'IMPORTE QUELLE SURFACE.

**CUIDADO:** FAVOR DE LEER TODAS LAS INSTRUCCIONES ANTES DE ENSAMBLAR SU PRODUCTO, ESTAS. PIEZAS SON PESADAS. PARA PREVENIR HERIDAS PERSONALES Y ASEGURAR QUE SU PRODUCTO NO SEA DAN ADO MIENTRAS ES ENSAMBLADO. SE RECOMIENDA LA ASISTENCIA DE UNA O MAUS PERSONAS.

**WARNING:** PROTECTIVE GLIDE IS PLACED UNDER EACH LEG OF THE FURNITURE TO RESIST SCRATCHES ON FLOOR SURFACE. SOME FLOOR SURFACES CAN BE EXTRA SENSITIVE TO SCRATCHES AND MARKINGS, IF YOU ARE NOT SURE CONSULT WITH YOUR DEALER. AVERTISSEMENT. LES PIEDS DES MEUBLES SONT MUNIS DE PATINS DESTINES A PROTEGER LE PLANCHER. CERTAINS REVETEMENTS DE SOL PEUVENT ETRE TRES FRAGILES. EN CAS DE DOUTE. CONSULTER LE MARCHAND.

LIST OF PARTS AND HARDWARE/ LISTE DES PIÈCES ET DU MATÉRIEL/ LISTA DE PIEZAS Y HARDWARE			
NO#/ NOMBRE/ NÚMERO	DESCRIPTION/ DESCRIPTION/ DESCRIPCIÓN		QUANTITY/ QUANTITÉ/ CANTIDAD
2	Lock Washer/ Rondelle De Blocage/ Arandela Auto De Bloqueo	5/16" x 1/2" 	8 PCS
3	Flat Washer/ Rondelle Plate /Arandela Plana	5/16" x 3/4" 	8 PCS
5	Studs/ Studs / Los Estudios	5/16" x 3-1/2"L 	8 PCS
6	Nut/ Écrou/ Nuez	5/16" x 1/2" 	8 PCS
7	Wrench/ Clé/ Llave inglesa		1 PC
8	Screw/ Vis/ Tornillo	#8 x 1"L 	8 PCS

LIST OF PARTS AND HARDWARE/ LISTE DES PIÈCES ET DU MATÉRIEL/ LISTA DE PIEZAS Y HARDWARE			
NO#/ NOMBRE/ NÚMERO	DESCRIPTION/ DESCRIPTION/ DESCRIPCIÓN		QUANTITY/ QUANTITÉ/ CANTIDAD
H	Bun Foot /Pied chignon/ Pie de moño		2 PCS
E	Queen Footboard/ Pied de lit Queen/ Pie de cama Queen		1 PC
F	Side Rails (Packed As Single Item)/ Rails latéraux/ Carriles laterales		2 PCS
G	Slat For Queen Bed/ Latte Pour Lit Queen/ Listón Para Cama Queen		4 PCS
I	Support leg/ Jambe de force/ Pierna de apoyo		4 PCS

NOTE:  
ASSEMBLE UNIT ON A SOFT SURFACE.  
ASSEMBLEZ L'UNITÉ SUR UNE SURFACE MOLLE.  
ENSAMBLE LA UNIDAD EN UNA SUPERFICIE PLANA Y SUAVE.

DO NOT TIGHTEN BOLTS UNTIL ALL PARTS AND HARDWARE OF THE UNIT ARE ASSEMBLED.  
NE SERREZ PAS LES BOULONS JUSQU'À CE QUE L'UNITÉ SOIT COMPLÈTEMENT ASSEMBLÉE.  
NO APRIETE LOS TORNILLOS HASTA QUE LA UNIDAD ESTE COMPLETAMENTE ENSAMBLADA.

# ASSEMBLY INSTRUCTIONS INSTRUCTIONS DE MONTAGE INSTRUCCIONES DE MONTAJE

## QUEEN UPHOLSTERED FOOTBOARD

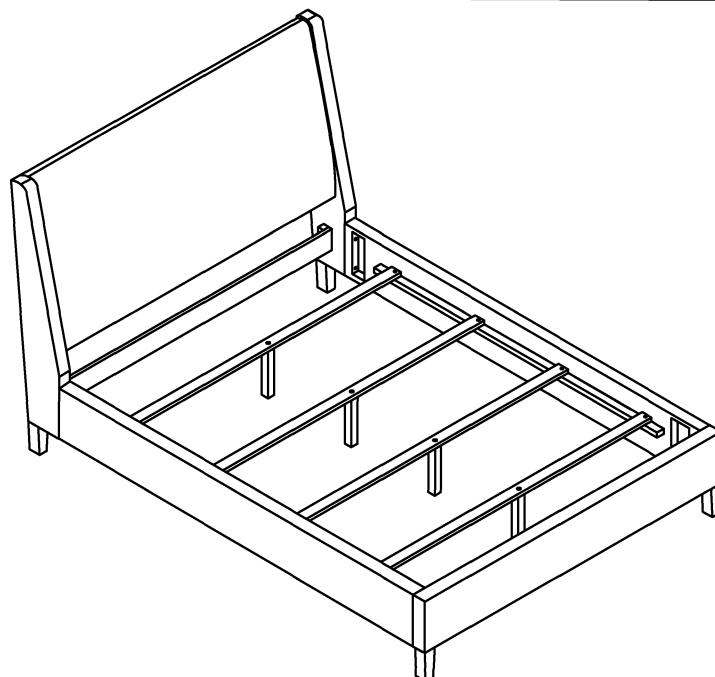
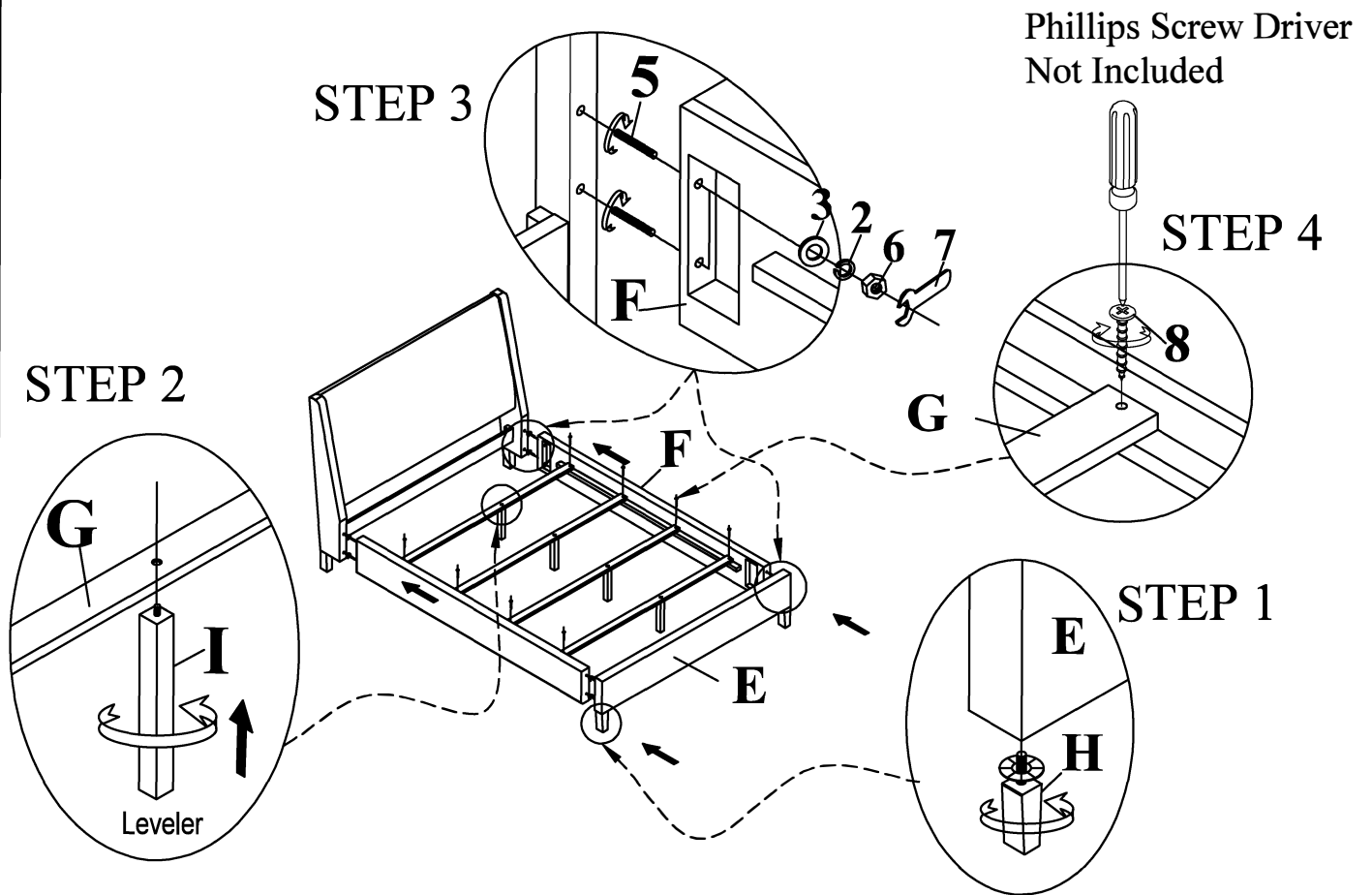

# ASSEMBLY INSTRUCTIONS INSTRUCTIONS DE MONTAGE INSTRUCCIONES DE MONTAJE





## QUEEN UPHOLSTERED HEABOARD KING UPHOLSTERED HEABOARD CAL KING UPHOLSTERED HEABOARD





**CAUTION:** PLEASE READ ALL INSTRUCTIONS BEFORE STARTING THE ASSEMBLY OF THIS PRODUCT. THESE PIECES ARE HEAVY. IN ORDER TO PREVENT PERSONAL INJURY AND ENSURE THAT THIS PRODUCT IS NOT DAMAGED DURING THE ASSEMBLY PROCESS, IT IS STRONGLY RECOMMENDED TO ENLIST THE ASSISTANCE OF ONE OR MORE PERSONS. IN CASE OF EXCESS STAIN, WIPE THE BOTTOM OF THE UNIT BEFORE PLACING ON ANY SURFACE.

**ATTENTION:** VEUILLEZ LIRE TOUTES LES INSTRUCTIONS AVANT DE COMMENCER L'ASSEMBLAGE DE CE PRODUIT. LES PIECES SONT LOURDES. POUR EVITER TOUTE BLESSURE ET POUR VOUS ASSURER QUE LE PRODUIT N'EST PAS ENDOMMAGE PENDANT L'ASSEMBLAGE, NOUS VOUS RECOMMANDONS DE FAIRE APPEL A UNE OU PLUSIEURS AUTRES PERSONNES. EN CAS DE TACHE EXCESSIVE, ESSUYEZ LE FOND DE L'UNITE AVANT LE PLACEMENT SUR N'IMPORTE QUELLE SURFACE.

**CUIDADO:** FAVOR DE LEER TODAS LAS INSTRUCCIONES ANTES DE ENSAMBLAR SU PRODUCTO, ESTAS PIEZAS SON PESADAS. PARA PREVENIR HERIDAS PERSONALES Y ASEGURAR QUE SU PRODUCTO NO SEA DANADO MIENTRAS ES ENSAMBLADO. SE RECOMIENDA LA ASISTENCIA DE UNA O MAUS PERSONAS.

**WARNING:** PROTECTIVE GLIDE IS PLACED UNDER EACH LEG OF THE FURNITURE TO RESIST SCRATCHES ON FLOOR SURFACE. SOME FLOOR SURFACES CAN BE EXTRA SENSITIVE TO SCRATCHES AND MARKINGS, IF YOU ARE NOT SURE CONSULT WITH YOUR DEALER. AVERTISSEMENT. LES PIEDS DES MEUBLES SONT MUNIS DE PATINS DESTINES A PROTEGER LE PLANCHER. CERTAINS REVETEMENTS DE SOL PEUVENT ETRE TRES FRAGILES. EN CAS DE DOUTE. CONSULTER LE MARCHAND.

LIST OF PARTS AND HARDWARE/ LISTE DES PIÈCES ET DU MATÉRIEL/ LISTA DE PIEZAS Y HARDWARE				
NO#/ NOMBRE/ NÚMERO	DESCRIPTION/ DESCRIPTION/ DESCRIPCIÓN			QUANTITY/ QUANTITÉ/ CANTIDAD
1	Bolt/ Boulon/ Tornillo	5/16"x 2"L		10 PCS
2	Lock Washer/ Rondelle De Blocage/ Arandela Auto De Bloqueo	5/16"x 1/2"		10 PCS
3	Flat Washer/ Rondelle Plate /Arandela Plana	5/16"x 3/4"		10 PCS
4	Allen Wrench/ Clé Allen/ Llave Allen	3/16"		1 PC

LIST OF PARTS AND HARDWARE/ LISTE DES PIÈCES ET DU MATÉRIEL/ LISTA DE PIEZAS Y HARDWARE			
NO#/ NOMBRE/ NÚMERO	DESCRIPTION/ DESCRIPTION/ DESCRIPCIÓN		QUANTITY/ QUANTITÉ/ CANTIDAD
A	Headboard/ Tête de lit/ Cabecera		1 PC
B	Right arm / Bras droit / Brazo derecho		1 PC
C	Left arm / Bras gauche / Brazo izquierdo		1 PC
D	Crossbar/ Barre transversale/ Travesaño		1 PC
H	Bun Foot /Pied chignon/ Pie de moño		2 PCS

NOTE:  
ASSEMBLE UNIT ON A SOFT SURFACE.  
ASSEMBLEZ L'UNITÉ SUR UNE SURFACE MOLLE.  
ENSAMBLE LA UNIDAD EN UNA SUPERFICIE PLANA Y SUAVE.

DO NOT TIGHTEN BOLTS UNTIL **ALL PARTS AND HARDWARE OF** THE UNIT ARE ASSEMBLED.  
NE SERREZ PAS LES BOULONS JUSQU'À CE QUE L'UNITÉ SOIT COMPLÈTEMENT ASSEMBLÉE.  
NO APRIETE LOS TORNILLOS HASTA QUE LA UNIDAD ESTE COMPLETAMENTE ENSAMBLADA.

# ASSEMBLY INSTRUCTIONS INSTRUCTIONS DE MONTAGE INSTRUCCIONES DE MONTAJE

QUEEN UPHOLSTERED HEABOARD  
KING UPHOLSTERED HEABOARD  
CAL KING UPHOLSTERED HEABOARD

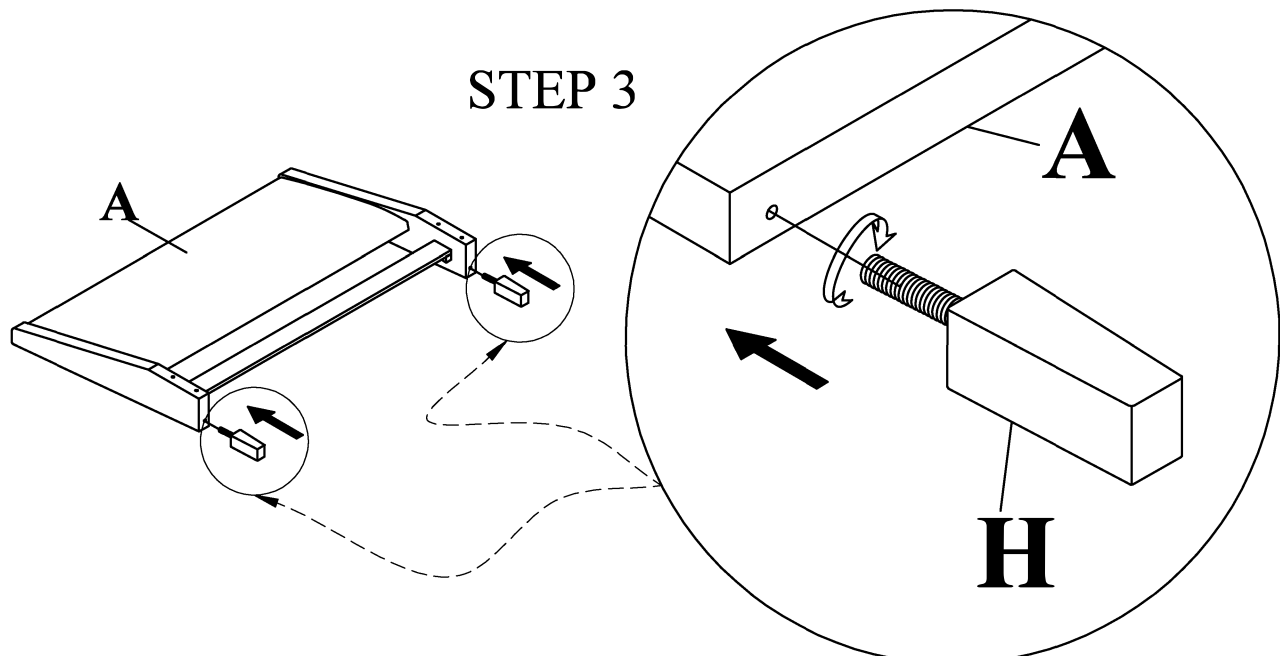
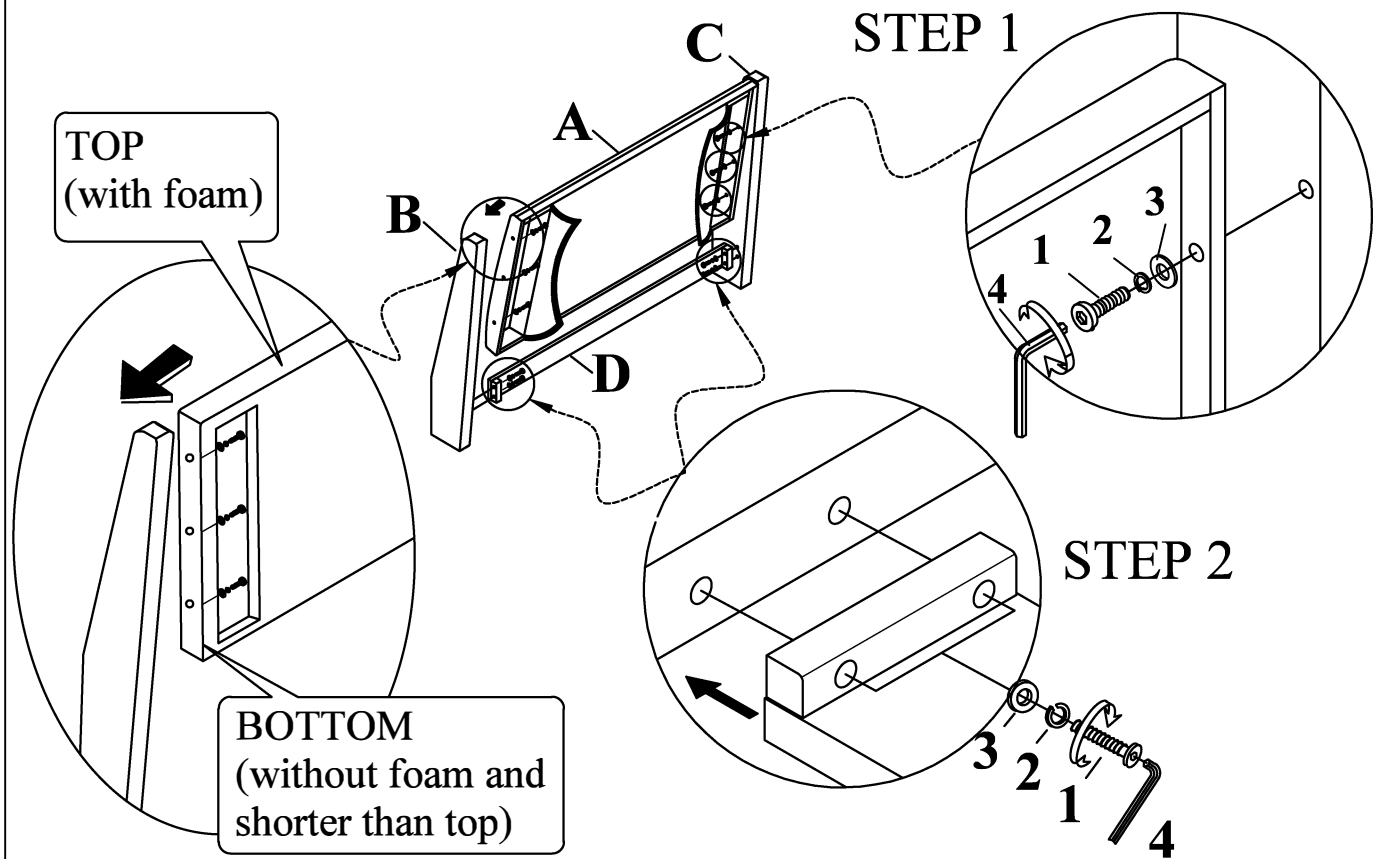

# ASSEMBLY INSTRUCTIONS INSTRUCTIONS DE MONTAGE INSTRUCCIONES DE MONTAJE

## KING UPHOLSTERED FOOTBOARD KING UPHOLSTERED FOOTBOARD







**CAUTION:** PLEASE READ ALL INSTRUCTIONS BEFORE STARTING THE ASSEMBLY OF THIS PRODUCT. THESE PIECES ARE HEAVY. IN ORDER TO PREVENT PERSONAL INJURY AND ENSURE THAT THIS PRODUCT IS NOT DAMAGED DURING THE ASSEMBLY PROCESS, IT IS STRONGLY RECOMMENDED TO ENLIST THE ASSISTANCE OF ONE OR MORE PERSONS. IN CASE OF EXCESS STAIN, WIPE THE BOTTOM OF THE UNIT BEFORE PLACING ON ANY SURFACE.

**ATTENTION:** VEUILLEZ LIRE TOUTES LES INSTRUCTIONS AVANT DE COMMENCER L'ASSEMBLAGE DE CE PRODUIT. LES PIECES SONT LOURDES. POUR EVITER TOUTE BLESSURE ET POUR VOUS ASSURER QUE LE PRODUIT N'EST PAS ENDOMMAGE' PENDANT L'ASSEMBLAGE, NOUS VOUS RECOMMANDONS DE FAIRE APPEL A UNE OU PLUSIEURS AUTRES PERSONNES. EN CAS DE TACHE EXCESSIVE, ESSUYEZ LE FOND DE L'UNITE' AVANT LE PLACEMENT SUR N'IMPORTE QUELLE SURFACE.





**CUIDADO:** FAVOR DE LEER TODAS LAS INSTRUCCIONES ANTES DE ENSAMBLAR SU PRODUCTO, ESTAS. PIEZAS SON PESADAS. PARA PREVENIR HERIDAS PERSONALES Y ASEGURAR QUE SU PRODUCTO NO SEA DAN ADO MIENTRAS ES ENSAMBLADO. SE RECOMIENDA LA ASISTENCIA DE UNA O MAUS PERSONAS.

**WARNING:** PROTECTIVE GLIDE IS PLACED UNDER EACH LEG OF THE FURNITURE TO RESIST SCRATCHES ON FLOOR SURFACE. SOME FLOOR SURFACES CAN BE EXTRA SENSITIVE TO SCRATCHES AND MARKINGS, IF YOU ARE NOT SURE CONSULT WITH YOUR DEALER.  
AVERTISSEMENT. LES PIEDS DES MEUBLES SONT MUNIS DE PATINS DESTINES A PROTEGER LE PLANCHER. CERTAINS REVETEMENTS DE SOL PEUVENT ETRE TRES FRAGILES. EN CAS DE DOUTE.CONSULTER LE MARCHAND.

### LIST OF PARTS AND HARDWARE/ LISTE DES PIÈCES ET DU MATÉRIEL/ LISTA DE PIEZAS Y HARDWARE

NO#/ NOMBRE/ NÚMERO	DESCRIPTION/ DESCRIPTION/ DESCRIPCIÓN	QUANTITY/ QUANTITÉ/ CANTIDAD
2	Lock Washer/ Rondelle De Blocage/ Arandela Auto De Bloqueo 5/16"	 8 PCS
3	Flat Washer/ Rondelle Plate /Arandela Plana 5/16"	 8 PCS
5	Studs/ Studs / Los Estudios 5/16"x100mm	 8 PCS
6	Nut/ Écrou/ Nuez 5/16"x13x H6mm	 8 PCS
7	Wrench/ Clé/ Llave inglesa 13mm	 1 PC
8	Screw/ Vis/ Tornillo M4 x 32mm	 8 PCS

### LIST OF PARTS AND HARDWARE/ LISTE DES PIÈCES ET DU MATÉRIEL/ LISTA DE PIEZAS Y HARDWARE

NO#/ NOMBRE/ NÚMERO	DESCRIPTION/ DESCRIPTION/ DESCRIPCIÓN	QUANTITY/ QUANTITÉ/ CANTIDAD
H	Bun Foot /Pied chignon/ Pie de moño	 2 PCS
E	King Footboard/ Pied de lit King/ Pie de rey	 1 PC
F	Side Rails (Packed As Single Item)/ Rails latéraux/ Carriles laterales	 2 PCS
G	Slat For King Bed/ Latte Pour Lit King/ Listón para cama King	 4 PCS
I	Support leg/ Jambe de force/ Pierna de apoyo	 12 PCS

NOTE:  
ASSEMBLE UNIT ON A SOFT SURFACE.  
ASSEMBLEZ L'UNITÉ SUR UNE SURFACE MOLLE.  
ENSAMBLE LA UNIDAD EN UNA SUPERFICIE PLANA Y SUAVE.

DO NOT TIGHTEN BOLTS UNTIL ALL PARTS AND HARDWARE OF THE UNIT ARE ASSEMBLED.  
NE SERREZ PAS LES BOULONS JUSQU'À CE QUE L'UNITÉ SOIT COMPLÈTEMENT ASSEMBLÉE.  
NO APRIETE LOS TORNILLOS HASTA QUE LA UNIDAD ESTE COMPLETAMENTE ENSAMBLADA.

# ASSEMBLY INSTRUCTIONS INSTRUCTIONS DE MONTAGE INSTRUCCIONES DE MONTAJE

KING UPHOLSTERED FOOTBOARD  
KING UPHOLSTERED FOOTBOARD

