

- !** 1. Please do not cut the compressed packages until your sofa frame is completely assembled.
2. Compressed back cushions and pillows need to be fully fulfilled within 72 hours for your perfect use.
3. Please keep children away from plastic bags or any small pieces of stuff.

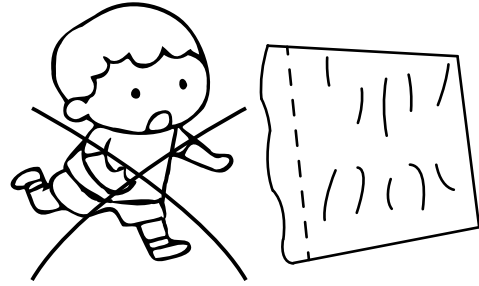

Cut compressed packages.

Pat around evenly plump.
Take the cushion cover and slip it.

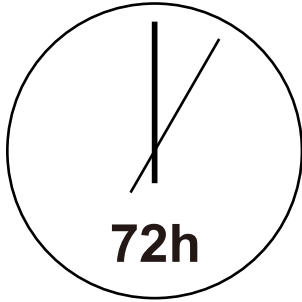
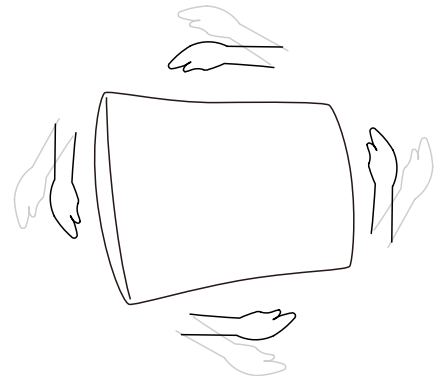
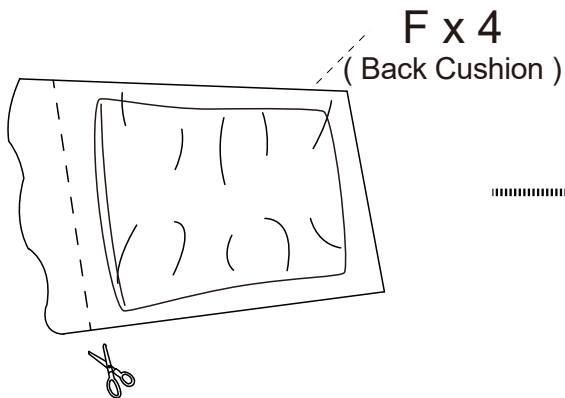
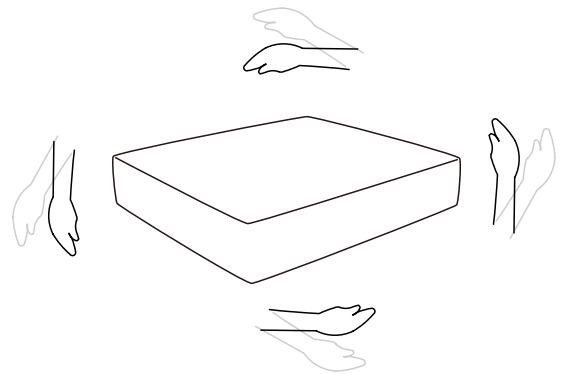
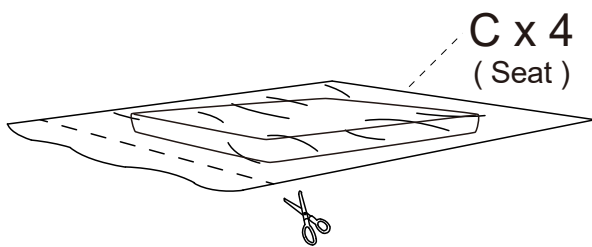

Assembly Instructions

(XG-068)



Assemble on the pad to prevent scratching the product.

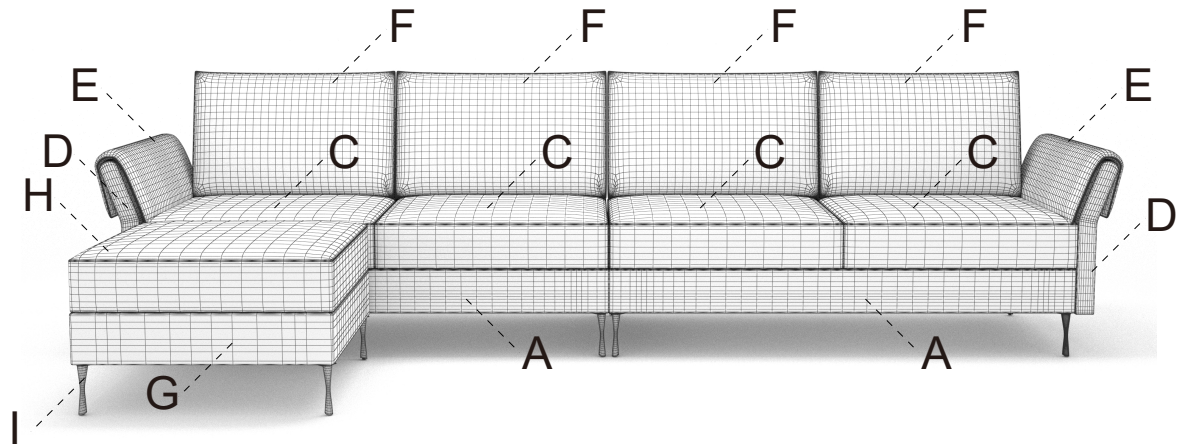

Parts List

Some parts are in bottom of seat base, Take out all parts and check QTY.

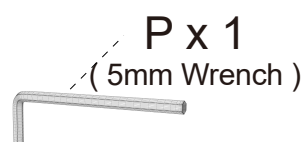
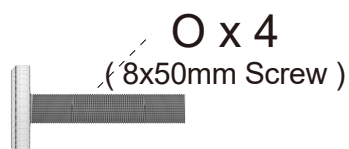
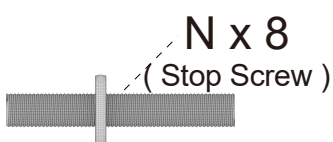
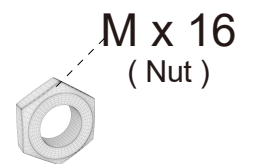
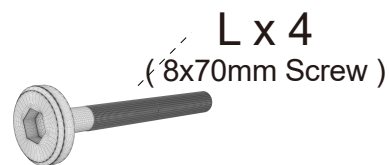
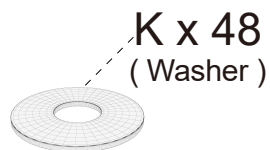
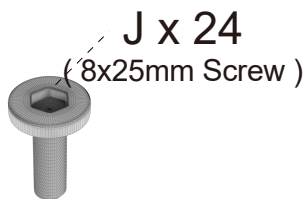
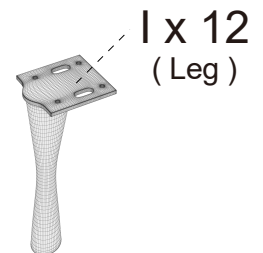
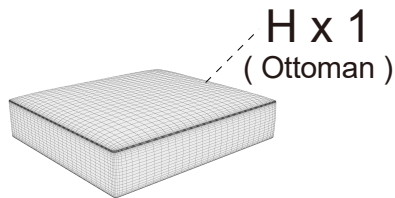
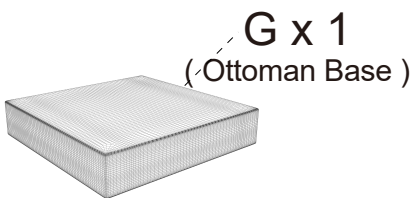
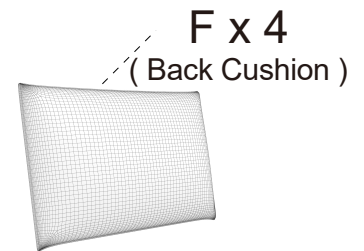
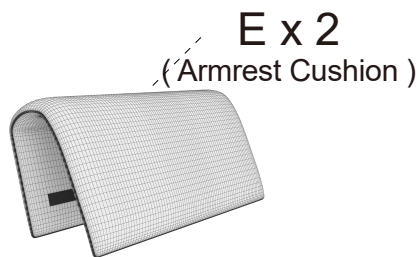
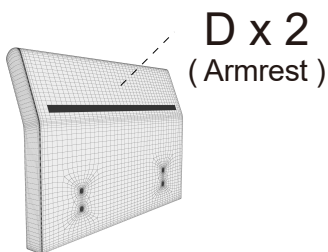
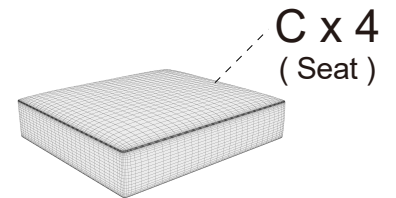
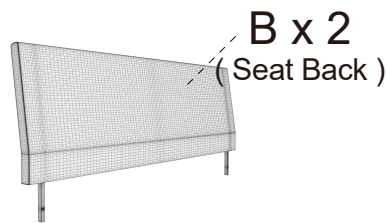
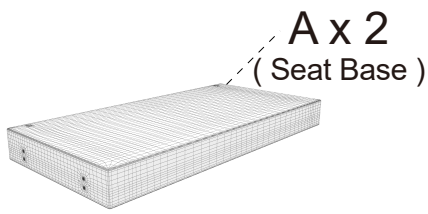

Step 1

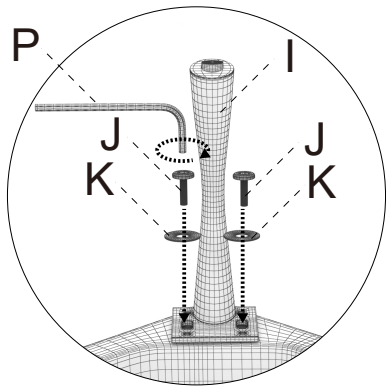

The step for "G" are the same.

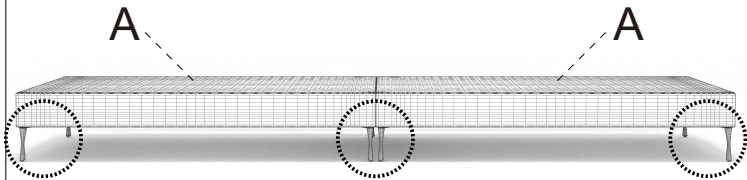

Step 2

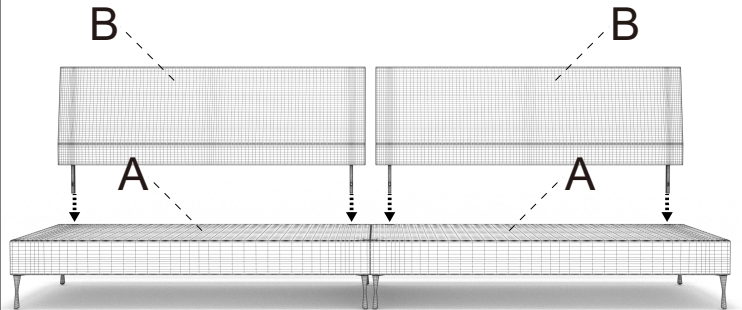
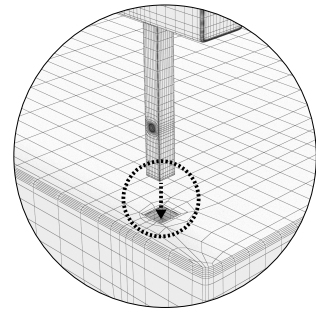

Step 3

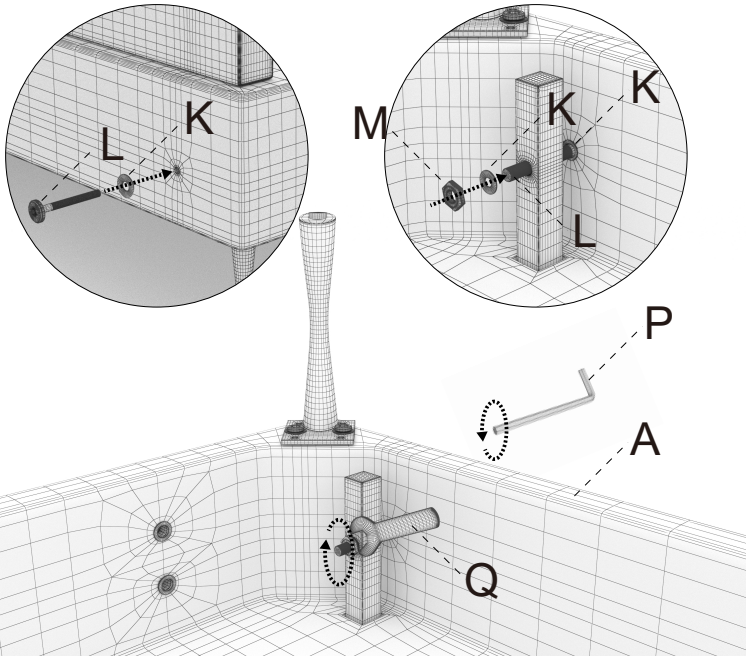

Step 4

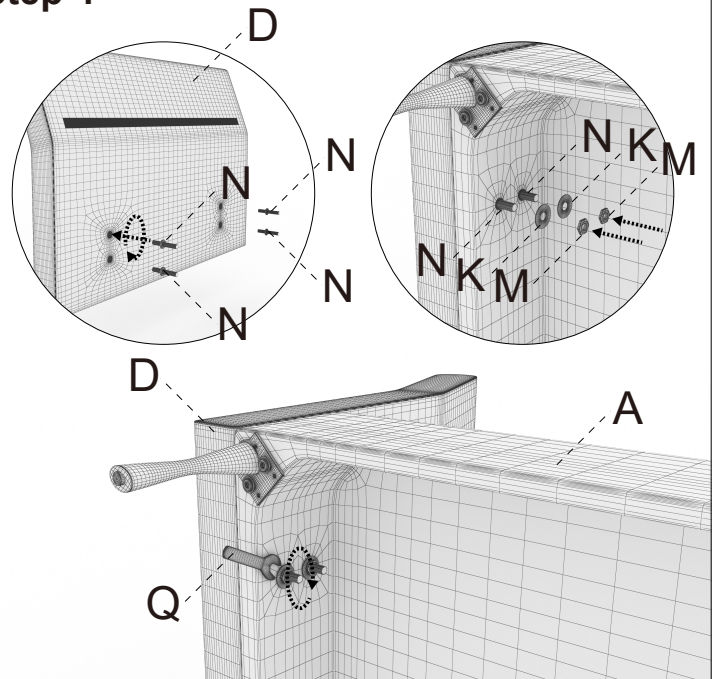

Step 5

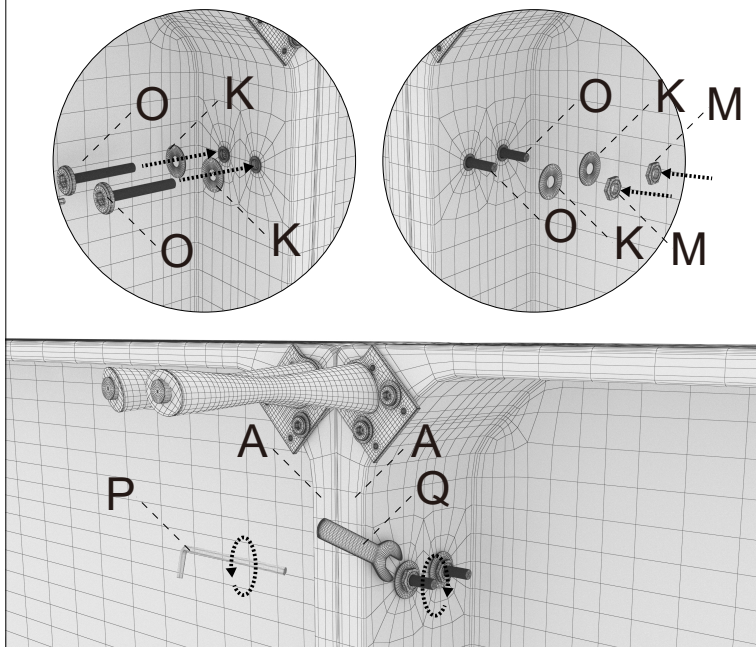

Step 6

