

Vintage Five-layer Shelf > Manual

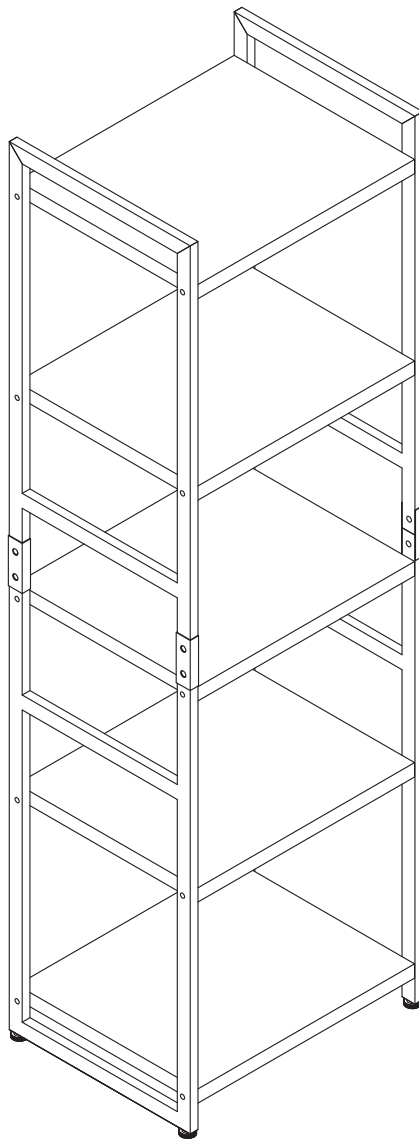

Thank you for purchase on products. Please contact us if you have difficulty with assembly or need replacement parts.

Please attach your User Name or Order ID so that we can assist you better.

Vielen Dank für Ihren Kauf von Produkten. Bitte kontaktieren Sie uns, wenn Sie Probleme mit Montage haben oder Ersatzteile benötigen.

EN

WARNING

Serious or fatal injury may occur from unexpected assembly or use.

1. During the assembly process, keep all parts away from babies or children.
2. Always securely fix this product to the wall. Make sure the wall area to be drilled is free from hidden electrical wires, water and gas pipes.
3. Use of tip-over restraints may only reduce, but not eliminate the risk of tip-over.
4. Unless specially designed to accommodate, do not set heavy objects on top of this product.
5. Place the heaviest items on the lowest shelf.
6. Never allow children to climb or bang on drawers, doors or shelves.

DE

WARNUNG

Bei unerwarteter Montage oder Verwendung können schwere oder tödliche Verletzung auftreten.

1. Legen Sie in den Montageprozess alle Teile weg von Babys oder Kindern.
2. Stellen Sie sicher, dass der gebohrte Wandbereich frei von verborgenen Stromkabeln, Wasser- und Gasleitungen ist, wenn Sie dieses Produkt an der Wand befestigen.
3. Die Verwendung von Kippsicherungen kann die Gefahr eines Kippens nur verringern, jedoch nicht beseitigen.
4. Setzen Sie bitte keine schweren Gegenstände auf dieses Produkt, es sei denn, dass das Produkt speziell für die Unterbringung konzipiert wird.
5. Legen Sie bitte die schwersten Gegenstände auf das unterste Regal.
6. Erlauben Sie nie Kindern, auf Schubladen, Türen oder Regale zu klettern oder zu knallen.



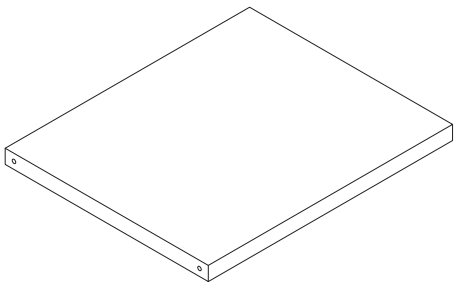
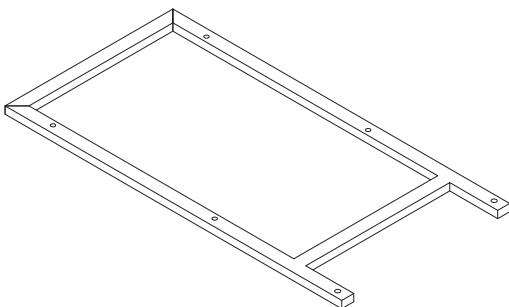
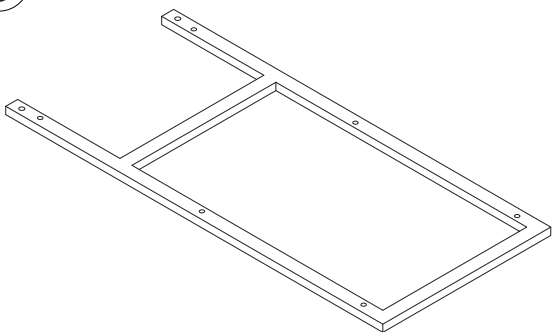
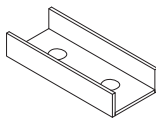
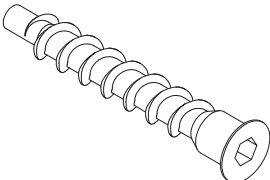
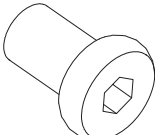
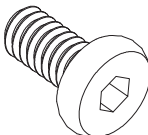
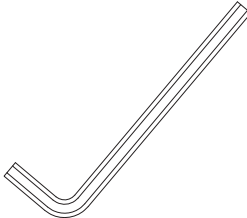
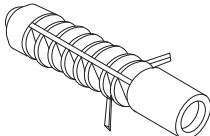
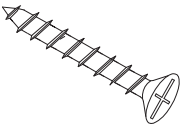
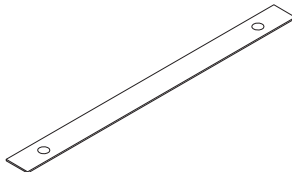
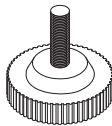

Parts List(EN) / Teile Liste(DE)

<p>1</p>  <p style="text-align: right; border: 1px solid black; padding: 2px;">5PCS</p>	<p>2</p>  <p style="text-align: right; border: 1px solid black; padding: 2px;">2PCS</p>		
<p>3</p>  <p style="text-align: right; border: 1px solid black; padding: 2px;">2PCS</p>	<p>4</p>  <p style="text-align: right; border: 1px solid black; padding: 2px;">4PCS</p>		
<p>A</p>  <p style="text-align: right; border: 1px solid black; padding: 2px;">20PCS</p>	<p>B</p>  <p style="text-align: right; border: 1px solid black; padding: 2px;">8PCS</p>	<p>C</p>  <p style="text-align: right; border: 1px solid black; padding: 2px;">8PCS</p>	<p>D</p>  <p style="text-align: right; border: 1px solid black; padding: 2px;">2PCS</p>
<p>E</p>  <p style="text-align: right; border: 1px solid black; padding: 2px;">1PC</p>	<p>F</p>  <p style="text-align: right; border: 1px solid black; padding: 2px;">1PC</p>	<p>G</p>  <p style="text-align: right; border: 1px solid black; padding: 2px;">1PC</p>	<p>H</p>  <p style="text-align: right; border: 1px solid black; padding: 2px;">4PCS</p>

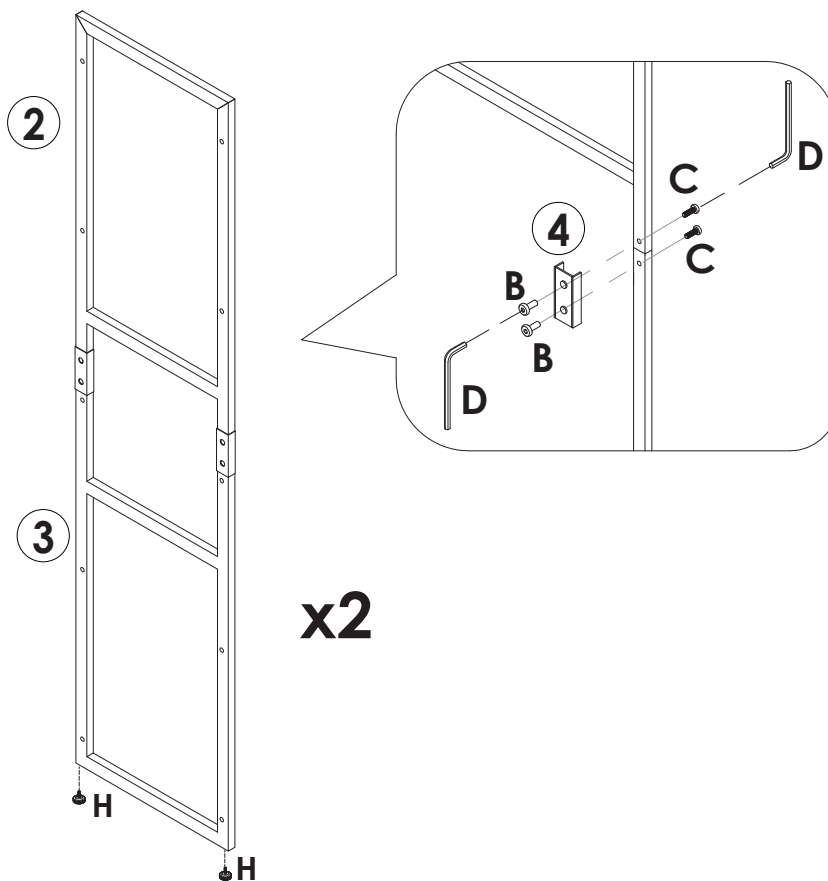
Assembly Steps(EN) / Montageschritte(DE)



STEP 1

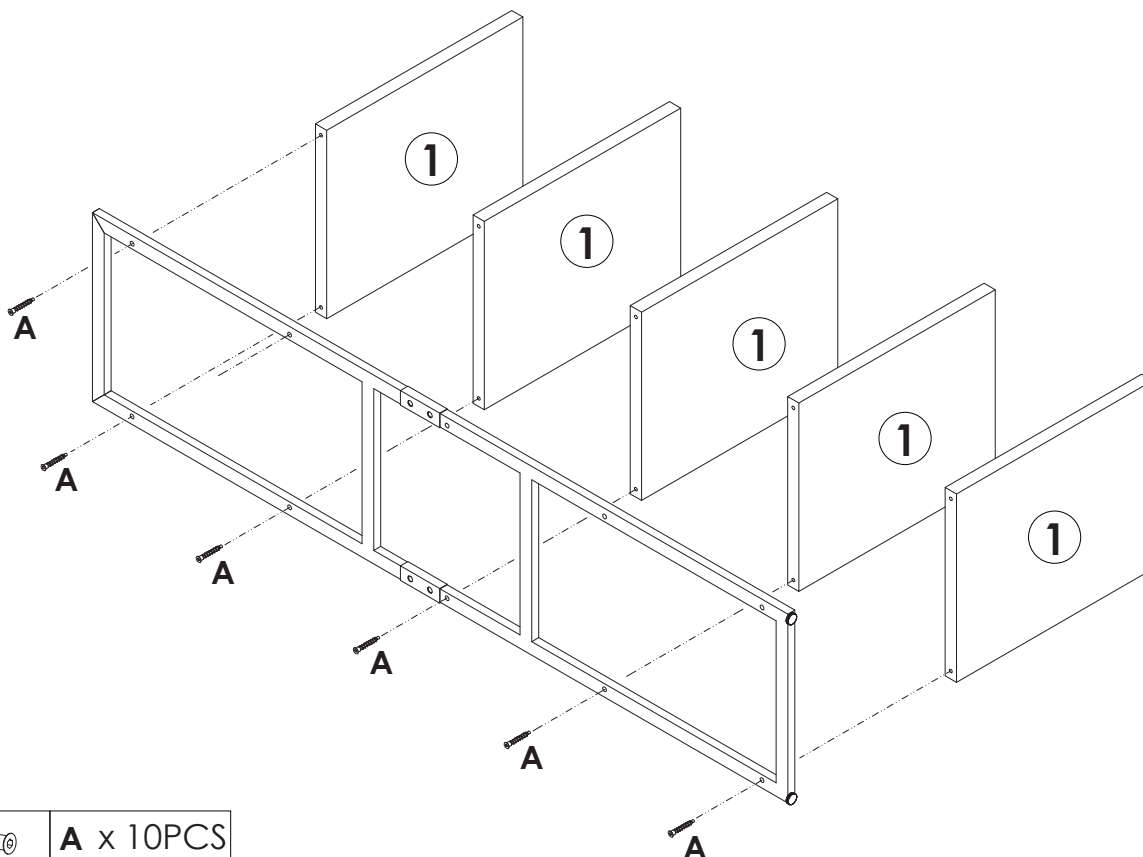

	B x 8PCS
	C x 8PCS
	D x 2PCS
	H x 4PCS

STEP 2





	A x 10PCS
	D x 1PC

Assembly Steps(EN) / Montageschritte(DE)

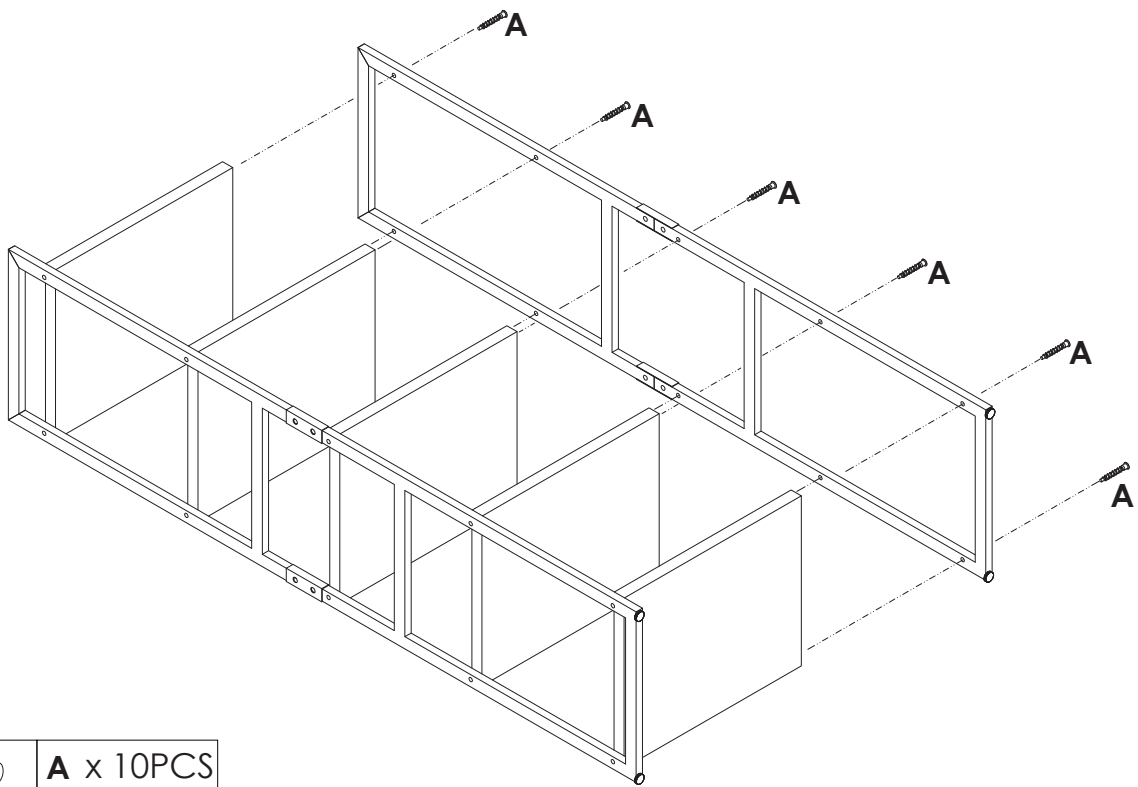

STEP 3

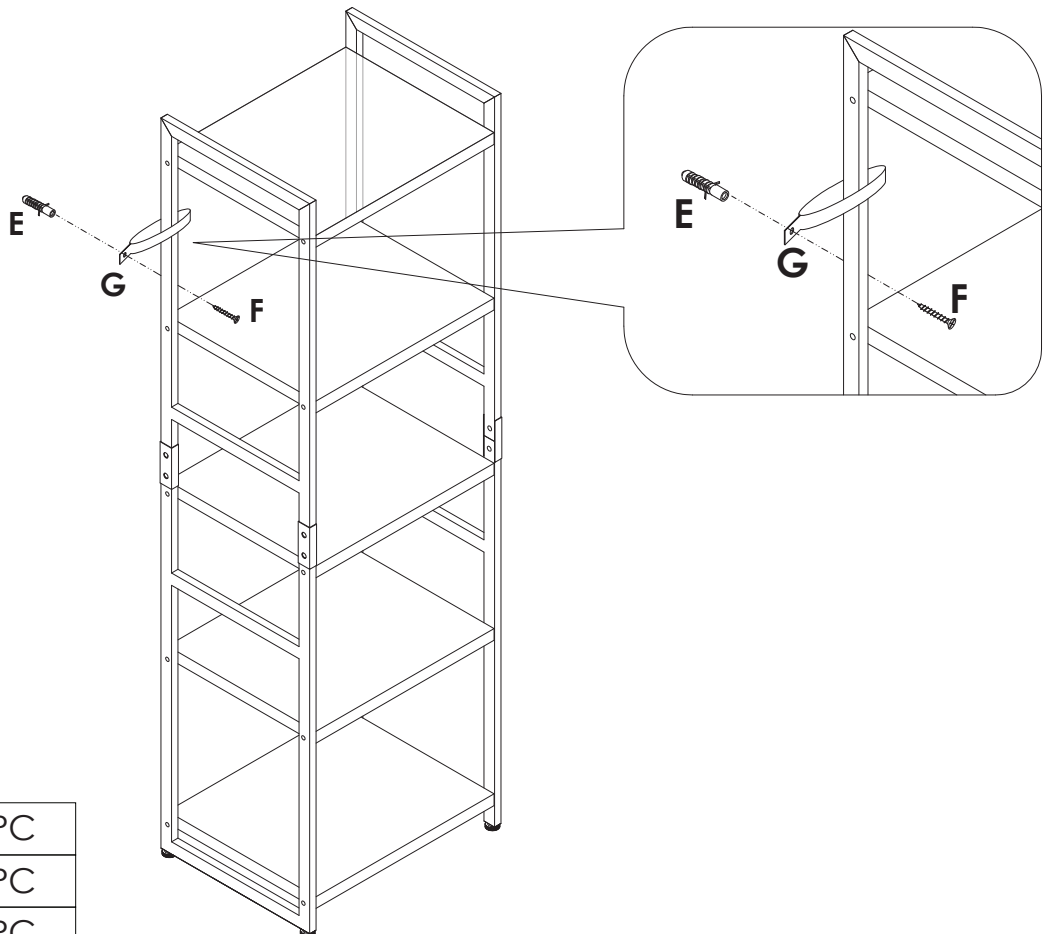

	A x 10PCS
	D x 1PC

STEP 4



	E x 1PC
	F x 1PC
	G x 1PC

Assembly Steps(EN) / Montageschritte(DE)

STEP 5

