

Motion Sensors Instruction Manual

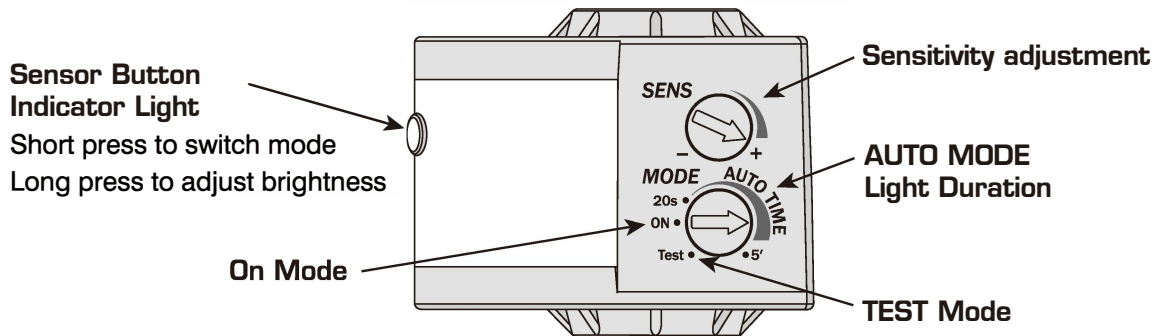

Quick Sensor Setup:

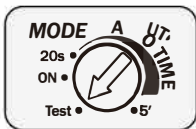

Fig.AA

TEST MODE: When the fixture is powered on, it will illuminate for 15 seconds regardless of day or night, continuously testing the functionality of the fixture and bulb. It will then switch to the motion sensor test mode, where the fixture's sensor will briefly light up in response to motion to assist in the installation test. (The test mode is only for installation testing and is not a normal working mode.)(Fig.AA)

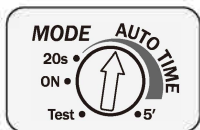
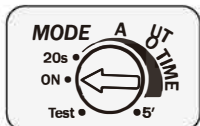

Fig.BB

AUTO TIME: After completing the initialization test, turn the MODE knob from "Test" to the "AUTO TIME" range (20s–5'). You can adjust how long the light stays on after motion is detected—from 20 seconds to 5 minutes.

The MODE knob must be turned to the "AUTO TIME" range (2s–5min) before you can use any automatic mode (DIM, ECO, or D2D).(Fig.CC)



ON MODE: In the On mode, the light will stay continuously lit with all sensor functions disabled (including D2D, motion detection, etc.), and will be controlled solely by your light switch for turning on and off.

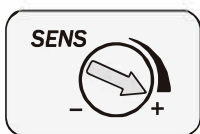

Sensitivity adjustment: Use the SENS knob to adjust the sensor's detection range between 5 and 40 feet, based on your requirements.

Sensor Button

Auto Mode Switch:

1. Turn the "MODE" knob to the " 20s–5' " range.
2. Short press to switch mode. (Fig.CC)
3. DIM (default mode) > ECO > D2D

Adjust Light Brightness:

- Long press to adjust brightness. (Fig.CC)



Fig.BB

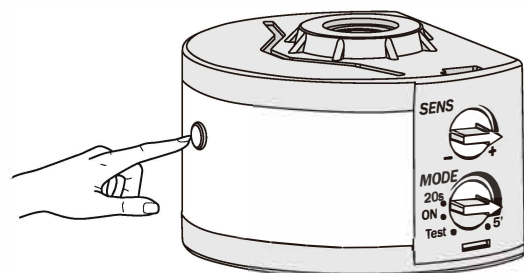

Fig.CC



Motion Sensor Operating Mode:

* Light brightness adjustable

Working Mode	Indicator Light	Day	Night	Motion Detected	Night	
DIM MODE 	Sensor button switch	Red Light	☀ OFF	🌙 30%* ON	🚶 100% ON	🌙 30% ON
ECO MODE 		Green Light	☀ OFF	🌙 OFF	🚶 100%* ON	🌙 OFF
D2D MODE 		Blue Light	☀ OFF	🚶 100%* On at night		
OVERRIDE MODE 	OFF	☀ OFF	🌙 100% On for 8 hours. Then resume previous working mode			
TEST MODE 	White Light	☀ 30% ON	🌙 30% ON	🚶 100% ON for 3 sec	🌙 30% ON	
ON MODE 	OFF	🚶 100%* On/Off – Completely Controlled by the Light Switch				

DIM MODE – Low Light at Night When No Motion is Detected

Stays at 15%–50% brightness at night when no motion is detected.

Turns full bright when motion is detected, then returns to dim mode. The light is completely off at dawn.

- *Ideal for: Front doors, porches, walkways*
- *Benefits: Continuous gentle lighting, good nighttime visibility, a balanced choice for safety and energy saving*

ECO MODE – Full Brightness at Night on Motion Detection, Off When No Motion is Detected

At night, the light turns to full brightness when motion is detected, and turns off when no motion is detected. The light is completely off at dawn.

- *Ideal for: Driveways, garden paths, outdoor patios*
- *Benefits: Maximized energy efficiency, automated control, immediate illumination for nighttime activities*

D2D MODE – Automatically Turns On at Dusk and Off at Dawn

The light automatically turns on at dusk and stays on throughout the night, then turns off at dawn.

Motion sensor is disabled in this mode for uninterrupted lighting.

- *Ideal for: Areas facing streets, walkways, or frequently used paths*
- *Benefits: Reliable all-night lighting, further enhanced nighttime safety*

OVERRIDE 8H MODE: Turn the light switch "off-on" within 2 seconds. The wall light will be forced to maintain 100% brightness for about 8 hours and then resume the last working.

Temporary scenarios where lights need to remain on throughout the night, such as parties, work, festivals, etc.

Adjust light brightness:

Press and hold the sensor button. The sensor indicator light and bulb will begin flashing, while the bulb cycles between bright and dim levels. Release the button when your desired brightness is achieved. The fixture will automatically save the current brightness setting.

- *In the DIM mode, you adjust the brightness in standby dim light mode to within a range of 15%-50%.*
- *In ECO | D2D | ON modes, you adjust the brightness in operational mode to a range of 15% -100 %.*

Please make sure to use dimmable LED light bulbs for this functionality.

Brightness settings are stored independently for each mode.

Restore factory settings

- Quickly toggle the power switch of the light fixture 5 times or more.
(OFF→ON→OFF→ON→OFF→ON→OFF→ON→OFF→ON)
- This action will clear all previous settings (brightness and detection distance) and restore the light fixture to its factory settings.

Basic Troubleshooting Guide

SYMPTOM	DAY/NIGHT	POSSIBLE CAUSE	SOLUTION
The light does not turn on	Day	After 15 seconds to initialize the lights, the lights will turn off during the day	Cover the sensor to test
	Night	The light switch or circuit breaker is off.	Turn on the wall switch or circuit breaker.
		The bulb has burned out.	Test the light bulb on a normal working light fixture or change another bulb to test.
		Light bulb is loose	Tighten the light bulb.
		Faulty or loose wire connections.	Check the wire connection.
		Too much light from other light sources shining on the sensor, such as street lights, etc.	Eliminate or dim another light source, Avoid strong light source shining onto the sensor, or reposition the light fixture
	Day	The sconce is installed in the shade.	Need to relocate the fixture or tune off the light manually
The light is always on	Night	Still on the manual override mode	Turn off the light. Then turn it on after 5 seconds
		False triggering is caused by a heat source, such as a heater, dryer vent, or heated swimming pool.	Avoid heat sources during installation or manually control with switches.
		In Dim mode, the dimming of a few LED bulbs is not obvious. 30% brightness looks similar to 100% brightness.	<ol style="list-style-type: none"> 1. Replace with incandescent bulbs or other brands of dimmable LED bulbs 2. Press and hold the button on the sensor to adjust the standby brightness in DIM mode, select the appropriate dim light brightness, and release the button.
The light bulb is flickering	Night	The bulbs used are non-dimmable bulbs or LED bulbs with poor dimming performance.	Change to incandescent bulbs, or buy dimmable LED bulbs from well-known brands.
The light comes on for no apparent reason.	Night	Street car or sidewalk traffic triggers the motion sensors.	Adjust the sensor's detection distance, or switch the light fixture to the D2D mode.
The sensor button cannot switch modes when pressed		<p>The MODE knob must be turned to the "AUTO TIME" range (2s–5min) before you can use any automatic mode (DIM, ECO, or D2D).</p> <p>When set to "Test" or "ON", switching modes via the button is disabled.</p>	 <p>The diagram shows a circular knob with an upward-pointing arrow. The knob is divided into sections labeled: MODE (top left), 20s (top), ON (middle left), Test (bottom left), and 5' (bottom right). A curved arrow labeled AUTO TIME spans from the 20s mark to the 5' mark.</p>

Motion Sensor Specifications



- This sensor requires the **DIMMABLE BULB** to work properly otherwise it may cause the bulb to flicker.
- Motion sensor light fixtures are unsuitable for dimmer switches. This can cause damage to the sensor chip.
- The Motion sensor's recommended installation height is about 6~7.2 feet.
- Do not have other intense light directly on the sensor, or install the lamps too close together, which may cause the sensor to enter the light-on-off cycle.

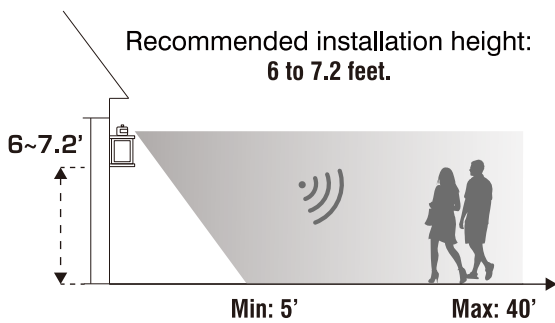

Please make sure the light is mounted straight on the wall the wall to avoid limiting the detection distance.

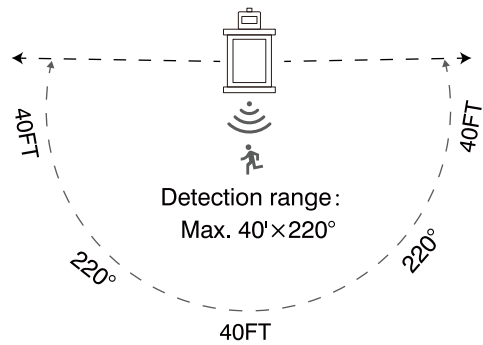

Motion Detection



DESCRIPTIONS	SPECIFICATIONS
Input power	120 VAC±10%, 60Hz
Load Rating	Max.100W
Activating light level	OFF→ON 10~90LUX ;ON→OFF Max.500LUX
Power Consumption	Max. 0.5Watt when stand-by
Working Temp	-22°F to 122°F (-30°C to 50°C)
Detection range:	Max. 40FT 220°
Waterproof rating:	Wet location
Safety standards:	Meet UL/ETL standard