

LAF Power Recliner with Power Headrest

IMPORTANT NOTE

Read these instructions carefully, and familiarize yourself with each procedure before assembling the furniture. Check that you have all the component parts, and familiarize yourself with each part before proceeding.

Take all the fittings out of the plastic bag and separate them into groups. Ensure you have enough space to lay out all the parts before assembly. To prevent damage to the parts, we recommend that you assemble the unit on a soft, level surface.

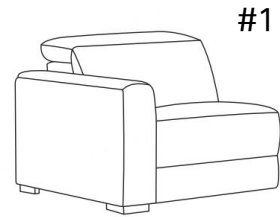

Part List

A. Wood Leg 2 pieces	B. Spanner 1 piece	C. Grommets 4 pieces	D. Screw 1# 4 pieces	E. Screw 2# 4 pieces	F. Plastic Feet 4 pieces	H. Transformer 1 piece
-------------------------	-----------------------	-------------------------	-------------------------	-------------------------	-----------------------------	---------------------------



Assembly Instructions

STEP 1

Detach the Transformer (H) and accessories from the bottom of the seat (See Figure 1.)

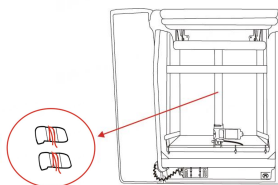

Figure 1

STEP 2

Take the accessories out then attach the Wood Leg (A) to the bottom of the seat with Screws (D) and Grommets (C), attach the Plastic Feet (F) with Screws (E). (See Figure 2.)

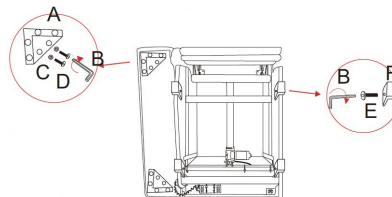

Figure 2

Assembly Instructions

STEP 3

Begin sectional connection by placing the piece # 1 in desired location in room. Then start sectional connection by placing # 2 into piece # 1. Continue sectional connection with piece # 3 thru #6 following the same method described above. (See Figure 3.)

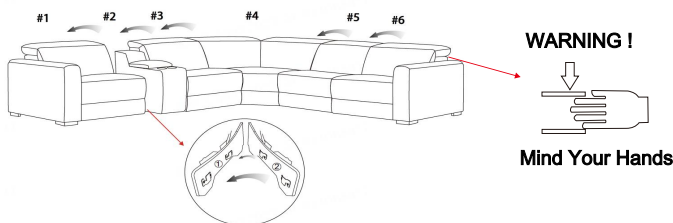

Figure 3

STEP 4

Locate the wire plug on sectional piece #6 and latch it to the wire-receiver on piece #5. Follow the same latching wire connection instructions for the remaining pieces 1-2-3 on opposite side. Use velcro provided on the bottom seat rails of each recliner to secure connection wires. (See Figure 4.) Connect firmly one end the wire plug transformer cord into the DC adaptor located in the lower back corner of the piece # 6 and piece # 1 recliners. Plug the transformer into a nearby outlet.

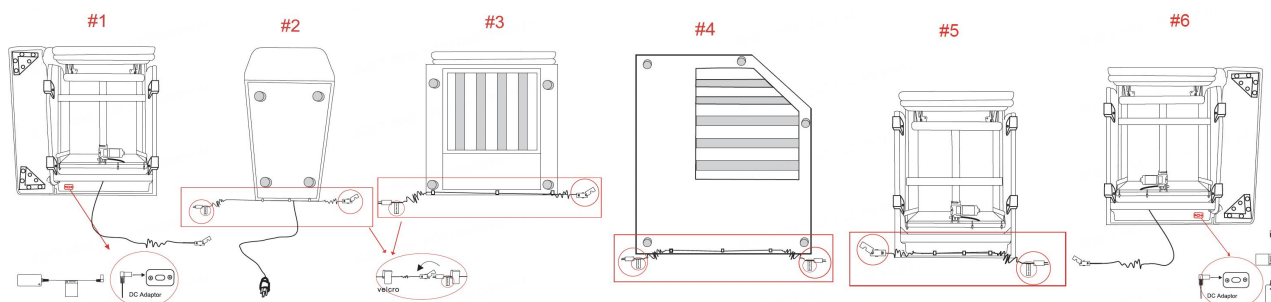

Figure 4

IMPORTANT NOTE

- To avoid any risk of suffocation to children or pets, dispose of all plastic bags immediately.
- To ensure proper performance, occasionally check for loose screws and tighten as needed.
- If the reclining functions are not working properly, check for loose cable connections before contacting the retailer.

RAF Power Recliner with Power Headrest

IMPORTANT NOTE

Read these instructions carefully, and familiarize yourself with each procedure before assembling the furniture. Check that you have all the component parts, and familiarize yourself with each part before proceeding.

Take all the fittings out of the plastic bag and separate them into groups. Ensure you have enough space to lay out all the parts before assembly. To prevent damage to the parts, we recommend that you assemble the unit on a soft, level surface.

#6

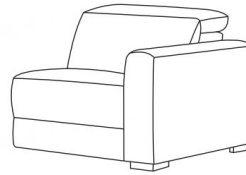

Part List

A. Wood Leg 2 pieces	B. Spanner 1 piece	C. Grommets 4 pieces	D. Screw 1# 4 pieces	E. Screw 2# 4 pieces	F. Plastic Feet 4 pieces	H. Transformer 1 piece
-------------------------	-----------------------	-------------------------	-------------------------	-------------------------	-----------------------------	---------------------------



Assembly Instructions

STEP 1

Detach the Transformer (H) and accessories from the bottom of the seat (See Figure 1.)

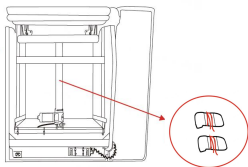

Figure 1

STEP 2

Take the accessories out then attach the Wood Leg (A) to the bottom of the seat with Screws (D) and Grommets (C), attach the Plastic Feet (F) with Screws (E). (See Figure 2.)

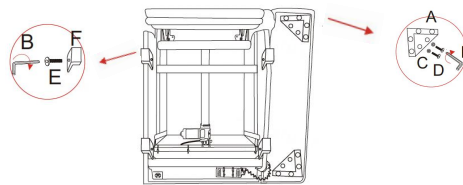

Figure 2

Assembly Instructions

STEP 3

Begin sectional connection by placing the piece # 1 in desired location in room. Then start sectional connection by placing # 2 into piece # 1. Continue sectional connection with piece # 3 thru #6 following the same method described above. (See Figure 3.)

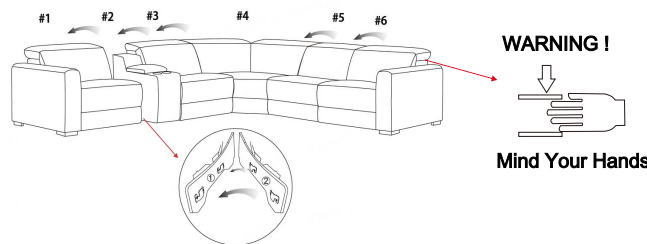

Figure 3

STEP 4

Locate the wire plug on sectional piece # 6 and latch it to the wire-receiver on piece # 5. Follow the same latching wire connection instructions for the remaining pieces 1-2-3 on opposite side. Use velcro provided on the bottom seat rails of each recliner to secure connection wires. (See Figure 4.) Connect firmly one end the wire plug transformer cord into the DC adaptor located in the lower back corner of the piece # 6 and piece # 1 recliners. Plug the transformer into a nearby outlet.

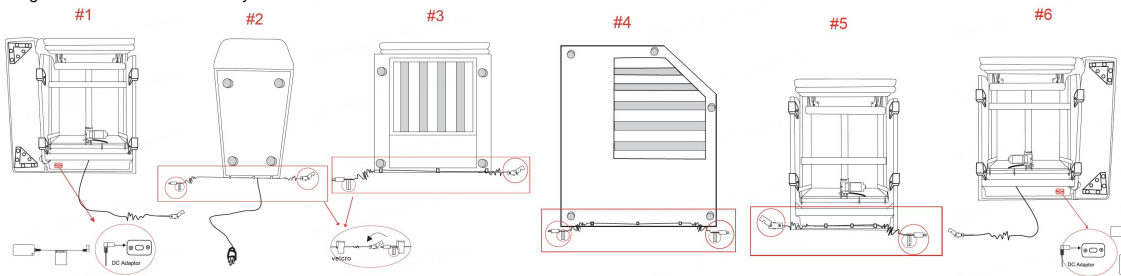

Figure 4

IMPORTANT NOTE

- To avoid any risk of suffocation to children or pets, dispose of all plastic bags immediately.
- To ensure proper performance, occasionally check for loose screws and tighten as needed.
- If the reclining functions are not working properly, check for loose cable connections before contacting the retailer.

Straight Console

IMPORTANT NOTE

Read these instructions carefully, and familiarize yourself with each procedure before assembling the furniture. Check that you have all the component parts, and familiarize yourself with each part before proceeding.

Take all the fittings out of the plastic bag and separate them into groups. Ensure you have enough space to lay out all the parts before assembly. To prevent damage to the parts, we recommend that you assemble the unit on a soft, level surface.

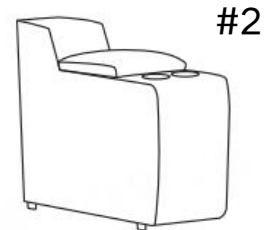

Assembly Instructions

STEP 1

Begin sectional connection by placing the piece # 1 in desired location in room. Then start sectional connection by placing # 2 into piece # 1. Continue sectional connection with piece # 3 thru #6 following the same method described above. (See Figure 1.)

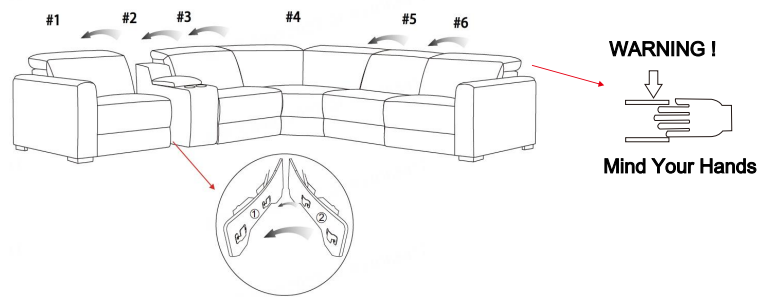

Figure 1

STEP 2

Locate the wire plug on sectional piece # 6 and latch it to the wire-receiver on piece # 5. Follow the same latching wire connection instructions for the remaining pieces 1-2-3 on opposite side. Use velcro provided on the bottom seat rails of each recliner to secure connection wires. (See Figure 2.) Connect firmly one end the wire plug transformer cord into the DC adaptor located in the lower back corner of the piece # 6 and piece # 1 recliners. Plug the transformer into a nearby outlet.

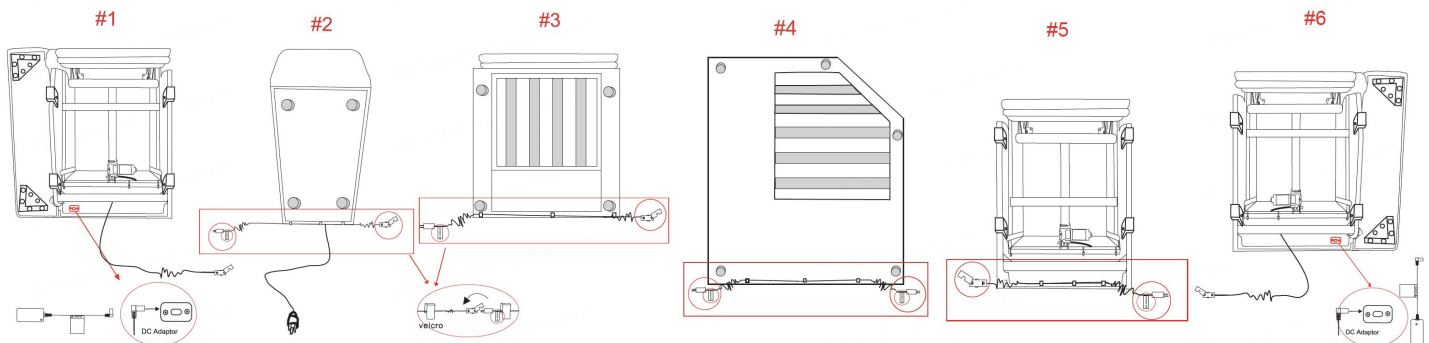

Figure 2

IMPORTANT NOTE

- To avoid any risk of suffocation to children or pets, dispose of all plastic bags immediately.
- To ensure proper performance, occasionally check for loose screws and tighten as needed.
- If the reclining functions are not working properly, check for loose cable connections before contacting the retailer.

Armless Chair with Power Headrest

IMPORTANT NOTE

Read these instructions carefully, and familiarize yourself with each procedure before assembling the furniture. Check that you have all the component parts, and familiarize yourself with each part before proceeding.

Take all the fittings out of the plastic bag and separate them into groups. Ensure you have enough space to lay out all the parts before assembly. To prevent damage to the parts, we recommend that you assemble the unit on a soft, level surface.

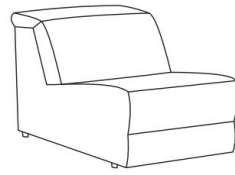

#3

Part List

G. Plastic Feet
4 pieces



Assembly Instructions

STEP 1

Detach the accessories from the bottom of the seat (See Figure 1.)

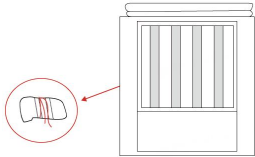

Figure 1

STEP 2

Take the accessories out then attach the Plastic Feet (G) to the bottom of the seat. (See Figure 2.)

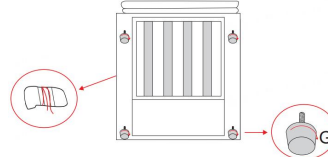

Figure 2

Assembly Instructions

STEP 3

Begin sectional connection by placing the piece # 1 in desired location in room. Then start sectional connection by placing # 2 into piece # 1.

Continue sectional connection with piece # 3 thru #6 following the same method described above.(See Figure 3.)

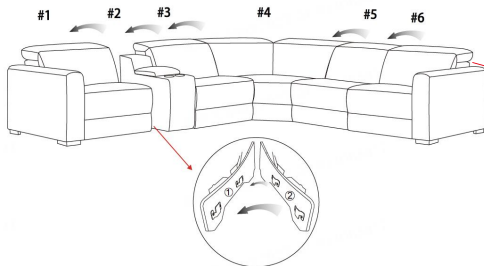

WARNING !

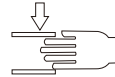

Mind Your Hands

Figure 3

STEP 4

Locate the wire plug on sectional piece # 6 and latch it to the wire-receiver on piece # 5.

Follow the same latching wire connection instructions for the remaining pieces 1-2-3 on opposite side.

Use velcro provided on the bottom seat rails of each recliner to secure connection wires.(See Figure 4.)

Connect firmly one end the wire plug transformer cord into the DC adaptor located in the lower back corner of the piece # 6 and piece # 1 recliners.

Plug the transformer into a nearby outlet.

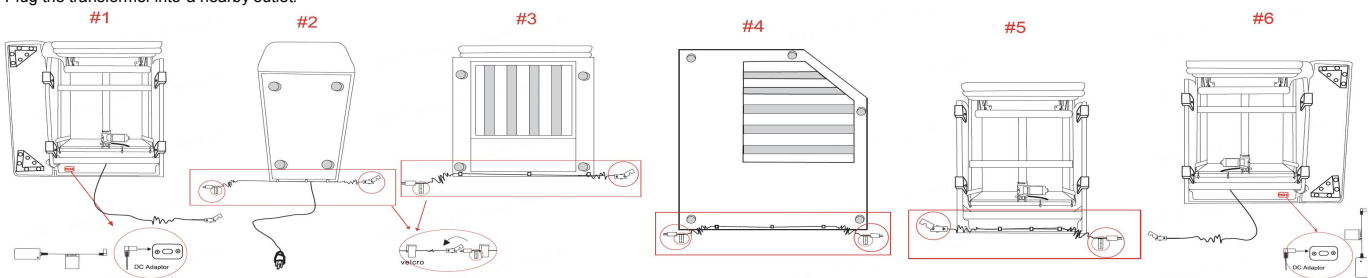

Figure 4

IMPORTANT NOTE

- To avoid any risk of suffocation to children or pets, dispose of all plastic bags immediately.
- To ensure proper performance, occasionally check for loose screws and tighten as needed.
- If the reclining functions are not working properly, check for loose cable connections before contacting the retailer.

Wedge with Power Headrest

IMPORTANT NOTE

Read these instructions carefully, and familiarize yourself with each procedure before assembling the furniture. Check that you have all the component parts, and familiarize yourself with each part before proceeding.

Take all the fittings out of the plastic bag and separate them into groups. Ensure you have enough space to lay out all the parts before assembly. To prevent damage to the parts, we recommend that you assemble the unit on a soft, level surface.

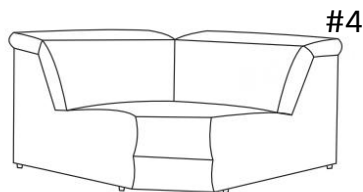

Part List

G. Plastic Feet
5 pieces



Assembly Instructions

STEP 1

Detach the Transformer (H) and accessories from the bottom of the seat (See Figure 1.)

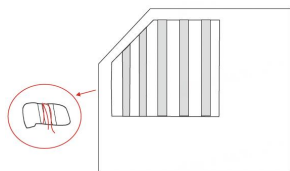

Figure 1

STEP 2

Take the accessories out then attach the Plastic Feet (G) to the bottom of the seat. (See Figure 2.)

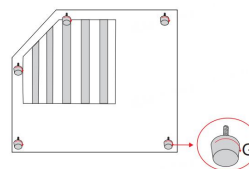

Figure 2

Assembly Instructions

STEP 3

Begin sectional connection by placing the piece # 1 in desired location in room. Then start sectional connection by placing # 2 into piece # 1. Continue sectional connection with piece # 3 thru #6 following the same method described above. (See Figure 3.)

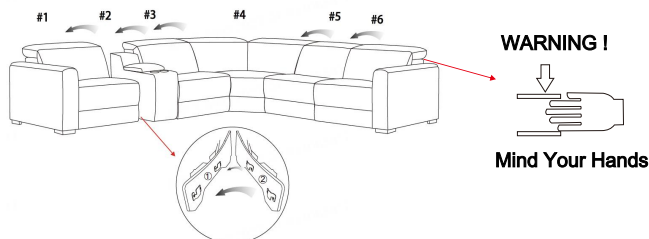

Figure 3

STEP 4

Locate the wire plug on sectional piece # 6 and latch it to the wire-receiver on piece # 5. Follow the same latching wire connection instructions for the remaining pieces 1-2-3 on opposite side. Use velcro provided on the bottom seat rails of each recliner to secure connection wires. (See Figure 4.) Connect firmly one end of the wire plug transformer cord into the DC adaptor located in the lower back corner of the piece # 6 and piece # 1 recliners. Plug the transformer into a nearby outlet.

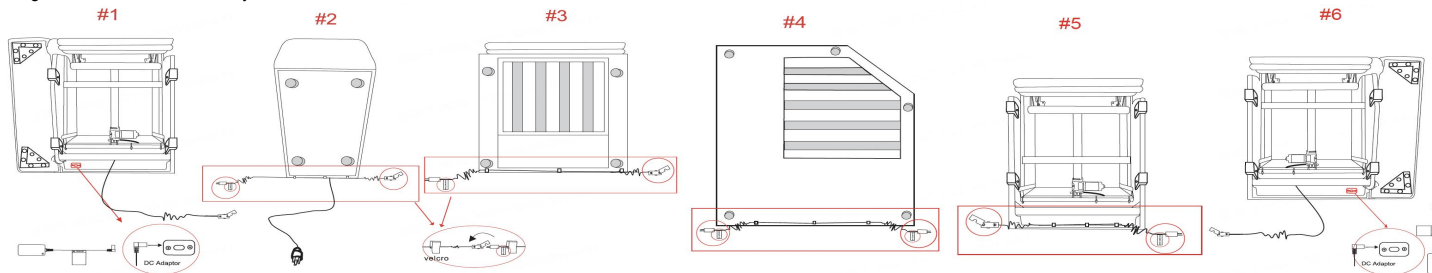

Figure 4

IMPORTANT NOTE

- To avoid any risk of suffocation to children or pets, dispose of all plastic bags immediately.
- To ensure proper performance, occasionally check for loose screws and tighten as needed.
- If the reclining functions are not working properly, check for loose cable connections before contacting the retailer.

Armless Power Recliner with Power Headrest

IMPORTANT NOTE

Read these instructions carefully, and familiarize yourself with each procedure before assembling the furniture. Check that you have all the component parts, and familiarize yourself with each part before proceeding.

Take all the fittings out of the plastic bag and separate them into groups. Ensure you have enough space to lay out all the parts before assembly. To prevent damage to the parts, we recommend that you assemble the unit on a soft, level surface.

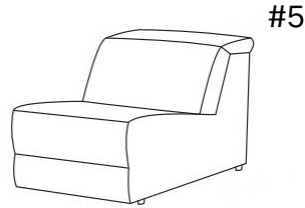

Part List

B. Spanner
1 piece

E. Screw 2#
4 pieces

F. Plastic Feet
4 pieces



Assembly Instructions

STEP 1

Detach the accessories from the bottom of the seat (See Figure 1.)

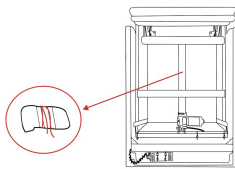

Figure 1

STEP 2

Take the accessories out then attach the Plastic Feet (F) with Screws (E). (See Figure 2.)

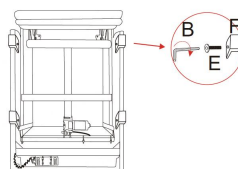

Figure 2

Assembly Instructions

STEP 3

Begin sectional connection by placing the piece # 1 in desired location in room.

Then start sectional connection by placing # 2 into piece # 1.

Continue sectional connection with piece # 3 thru #6 following the same method described above. (See Figure 3.)

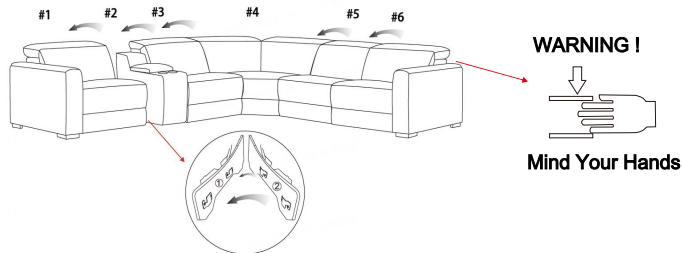

Figure 3

STEP 4

Locate the wire plug on sectional piece # 6 and latch it to the wire-receiver on piece # 5.

Follow the same latching wire connection instructions for the remaining pieces 1-2-3 on opposite side.

Use velcro provided on the bottom seat rails of each recliner to secure connection wires. (See Figure 4.)

Connect firmly one end the wire plug transformer cord into the DC adaptor located in the lower back corner of the piece # 6 and piece # 1 recliners.

Plug the transformer into a nearby outlet.

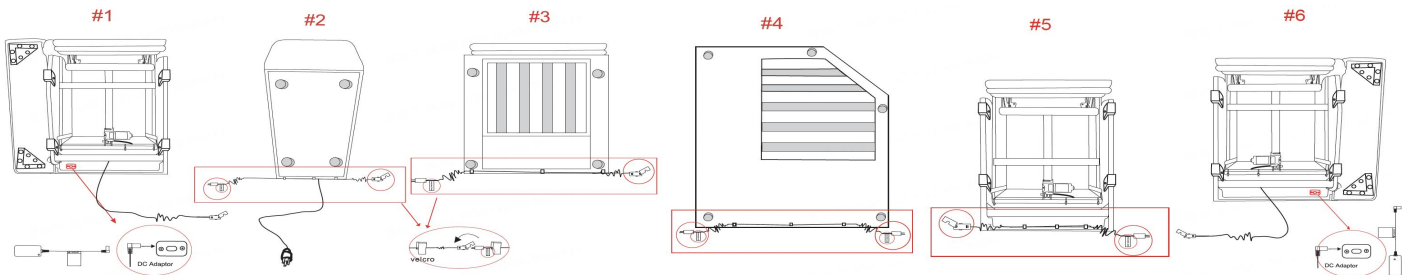

Figure 4

IMPORTANT NOTE

- To avoid any risk of suffocation to children or pets, dispose of all plastic bags immediately.
- To ensure proper performance, occasionally check for loose screws and tighten as needed.
- If the reclining functions are not working properly, check for loose cable connections before contacting the retailer.