

# Garden Chair

## Assembly Guide

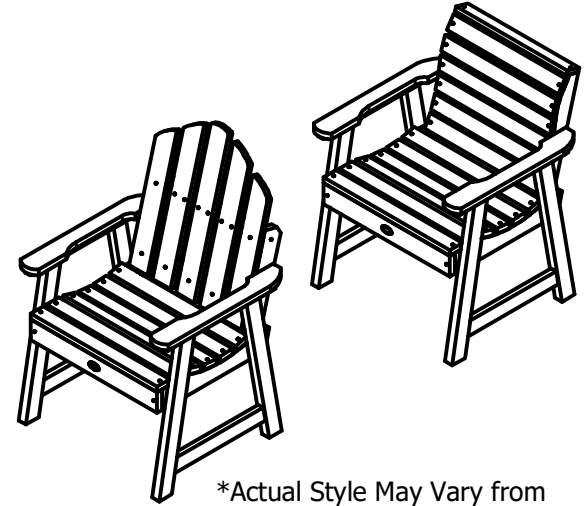
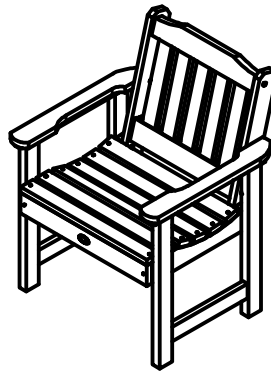

\*Actual Style May Vary from the One Pictured in this Guide

CHGL1  
CHGW1  
CHGC1  
CHGSQ01  
CHGSQ02

### HARDWARE INCLUDED

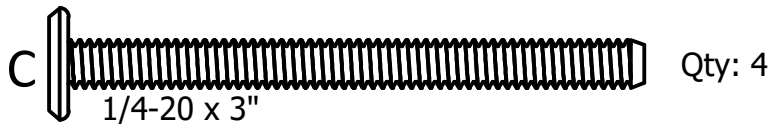
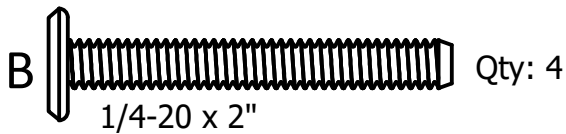
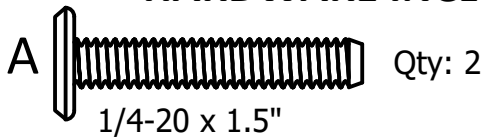

### TOOLS INCLUDED

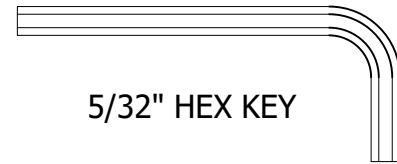

5/32" HEX KEY

### IMPORTANT!

DO NOT fully tighten bolts until all bolts are started.

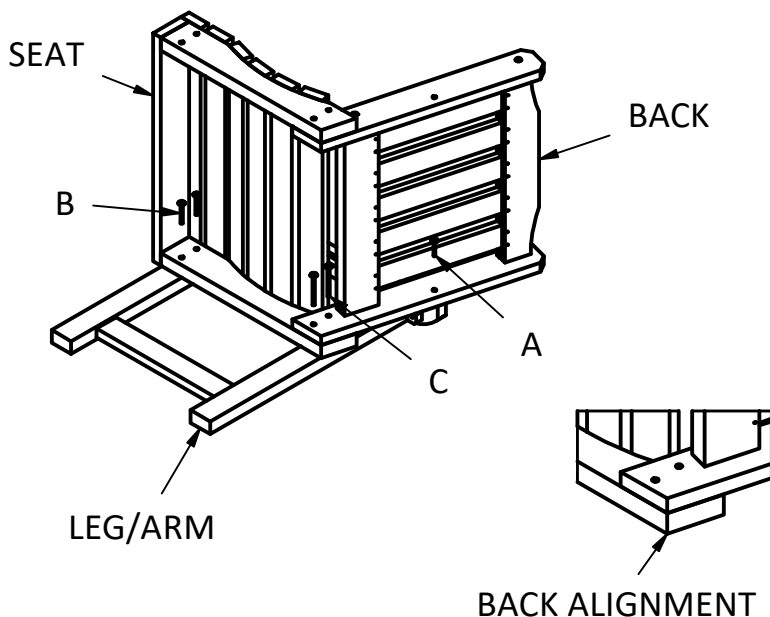

**1)** Attach Seat to Leg/Arm using (2) B bolts and (2) C bolts. (Align Back as shown for C bolts)

**2)** Attach Back to Leg/Arm using (1) A bolt

**3)** Repeat on other Side.