

ASSEMBLY INSTRUCTION

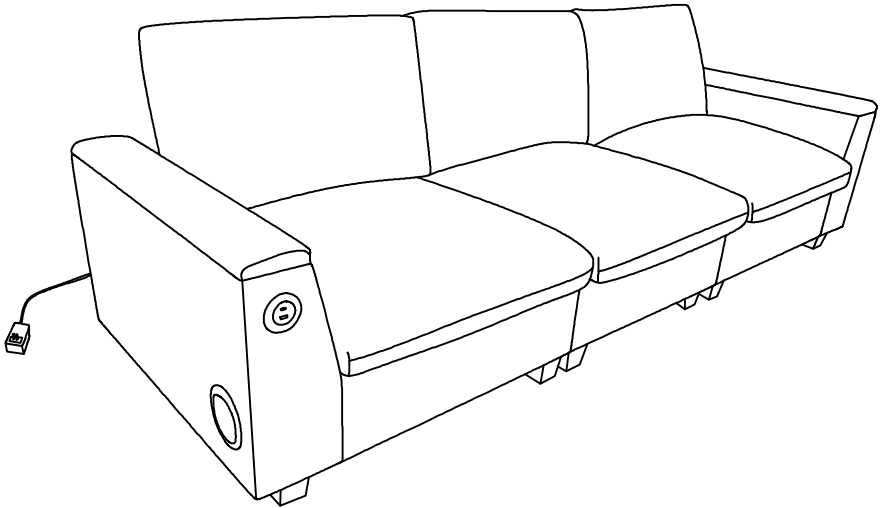

Sets often ship in multiple boxes and delivery date may vary.

CUSTOMER SERVICE

**Questions, Missing parts, Assembly help?
No need to return the product, we will gladly help and ship
your replacement parts free of charge.**

PRE-ASSEMBLY INFORMATION

Please read this manual carefully before beginning assembly of this product. Keep this manual for future reference.

NOTICE

1. Please assemble it AFTER all boxes are received.
2. Please do not throw away any of the packages or the instruction until the sofa is fully assembled.
3. Please keep children away from the plastic bags or any small pieces of stuff.
4. Some key parts of our product may be stored and hidden inside of other parts. Please open any zippered or hook & loop storage compartments to take out all parts.
5. Please do not open the compressed packages until your sofa frame is completely assembled.
6. As the cushions are all vacuum compressed, there will be some wrinkles. Please give them up to 72 hours to reach its original size and the wrinkles will basically disappear.
7. DO NOT INSTALL THE SCREWS ALL THE WAY IN THE BEGINNING. Place each screw into their proper hole and use your hand to twist the screw halfway. Twist all the screws in halfway to ensure the holes will match up properly and the product is level on the ground. When everything seems fitted, then tighten the screws.
8. Do not over tighten screws and bolts to avoid stripping.



2 adults recommended









Takes about 1.5 Hours to assemble

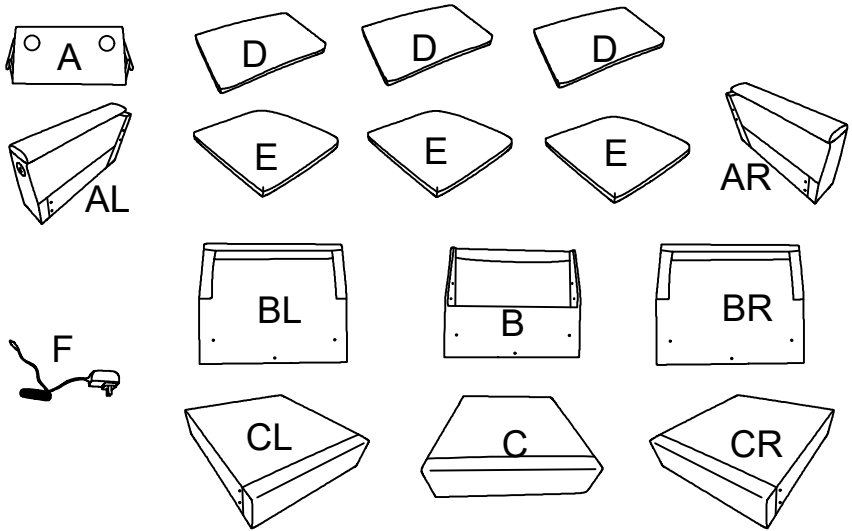

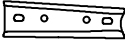
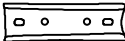
Weight capacity of each seat: 330LBS

COMPONENTS



HARDWARE			
NO	DESCRIPTION	SKETCH	QTY
①	Male Conical connector		4
②	Female Conical connector		4
③	Screws 6*30mm		13
④	Screws 6*15mm		20
⑤	Washer		13
⑥	Wrench		1
⑦	Gasket		14
⑧	Leg		14

COMPONENTS

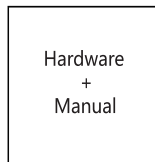
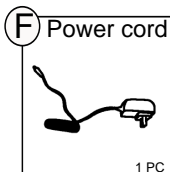
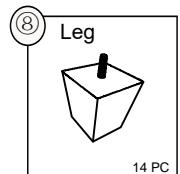
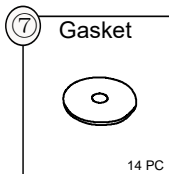
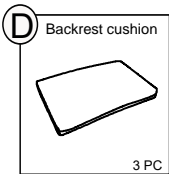
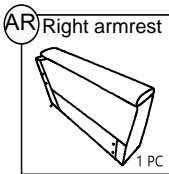
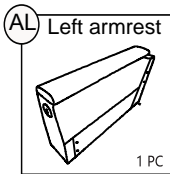
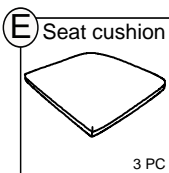
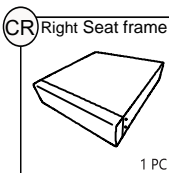
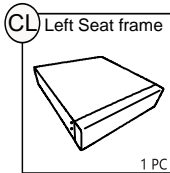
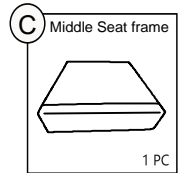
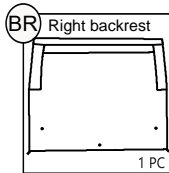
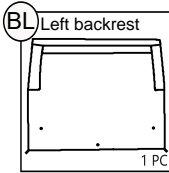
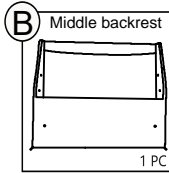
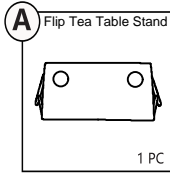

ASSEMBLY STEPS

STEP 1 Take out all the parts stored or hidden inside

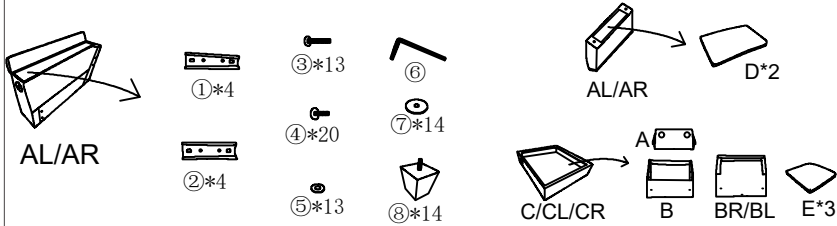

STEP 2 Install Female Conical connectors on Left armrest /Right armrest (AL/AR) with Screws 6*15mm by Wrench

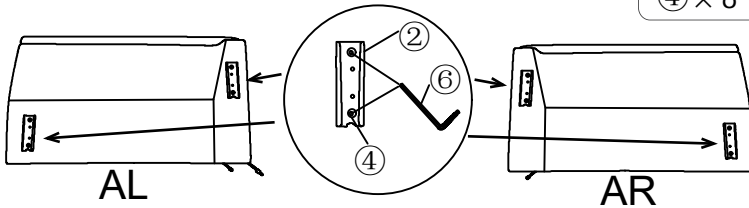
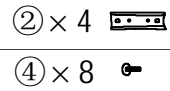

STEP 3 Install Flip Tea Table Stand(A) on Middle backrest(B) with Screws 6*15mm by Wrench

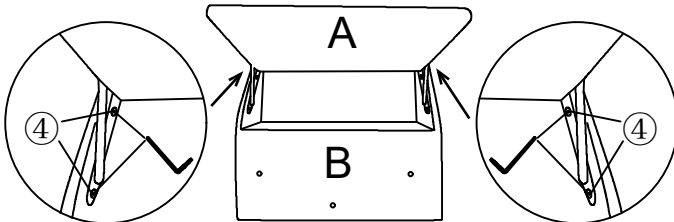
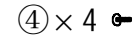

STEP 4 Install seat frame (CL,C,CR) on backrests (BL,B,BR) with Screws 6*30mm and washers by Wrench

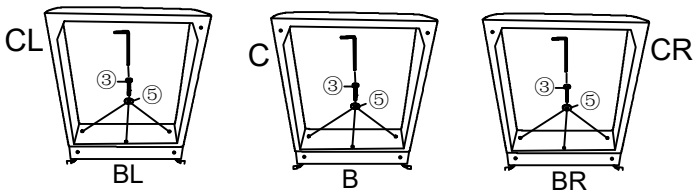
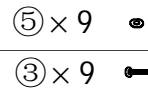

STEP 5

Install Male Conical connector ① on Left backrest / Right backrest (BL/BR) and Left seat frame/Right seat frame (CL/CR) with Screws 6*15mm by Wrench

① × 4 

④ × 8 

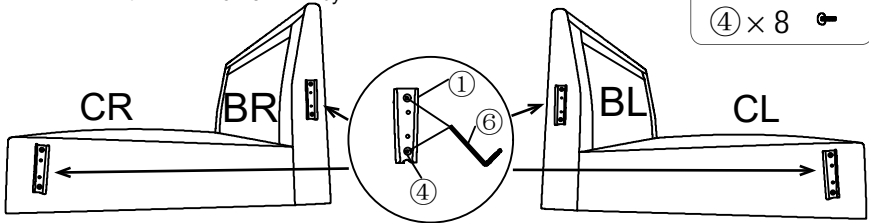
**STEP 6**

Insert Male Conical connector into Female Conical connector

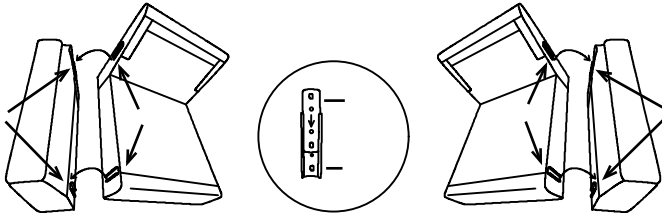
**STEP 7**

Attach legs and Gaskets ⑦ to the seat

⑦ × 14 

⑧ × 14 

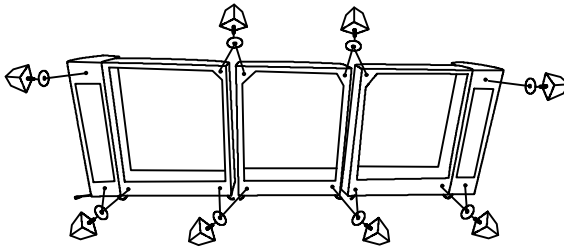
**STEP 8**

Assemble seat frames (BL,B,BR) with Screws 6*30mm, Washers by Wrench

⑤ × 4 

③ × 4 

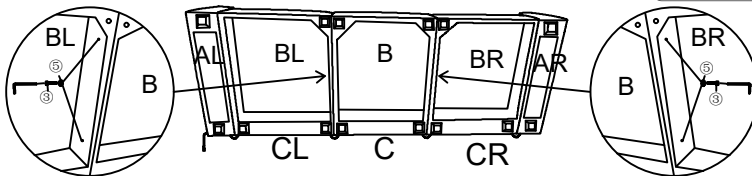

STEP 9 Connect the power cable behind the seat

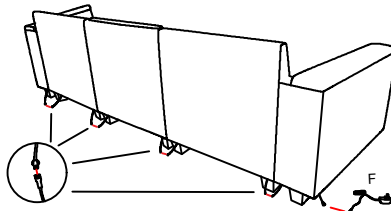

STEP 10 Open the vacuum bag and take the Seat cushions (E) and Backrest cushions (D). To restore the original shape, follow the steps below.

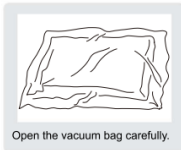

Open the vacuum bag carefully.



Press and tap with both hands from the side to fully inhale air.



Press and tap with both hands from the front to fully inflate.

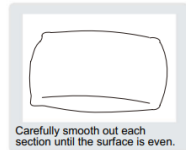

Carefully smooth out each section until the surface is even.

After packing up, place them in somewhere dry and ventilated. After about 72-96 hours. It can be restored to the best use condition.

STEP 11 Put the cushions (D,E) on the sofa.

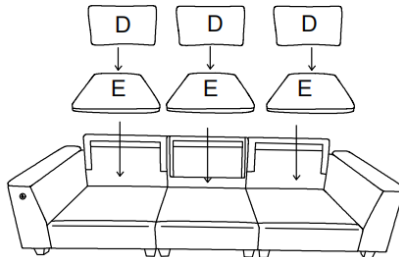

STEP 12 Complete

