

CARE AND MAINTENANCE

Spot clean using a mild water-free solvent. Only a professional cleaner should undertake a complete overall cleaning.

The use of steam or water-based cleaners may cause excessive shrinking or staining.







NOTICE

* Please make sure that you have all parts indicated before you begin assembly of this item

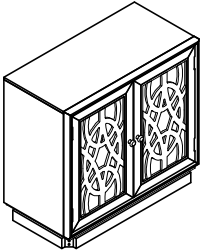
* This item should be assembled on a soft surface to prevent scratching the finish during assembly

* This item may require periodic tightening.

PART LIST AND HARDWARE LIST

PIECE	DESCRIPTION	PICTURE	QUANTITY
A	SERVER		1X
B	LEGS		4X
H1	BOLT	6.3*60 mm 	8X
H2	SPRING WASHER		8X
H3	WASHER		8X
H4	ALLEN KEY		1X
H5	ANTI TIP KIT		1X

Product Dimensions: 32"W x 16" D x 32" H

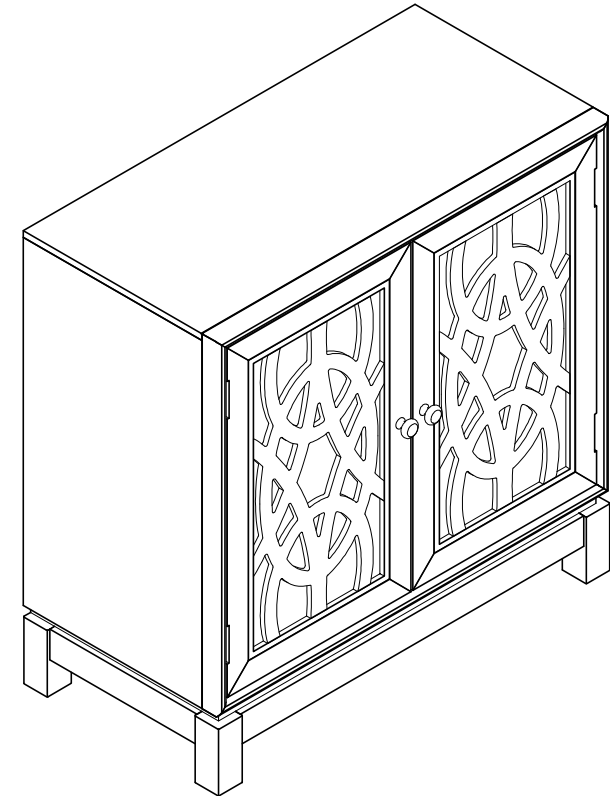

Weight capacity: 25lbs

WARNING: DO NOT STAND ON NIGHTSTAND

WARNING: DO NOT OVER TORQUE BOLTS

