

NOTICE





- * Please make sure that you have all parts indicated before you begin assembly of this item
- * This item should be assembled on a soft surface to prevent scratching the finish during assembly
- * This item may require periodic tightening
- * If you are having difficulty, our friendly Customer Care team is always here to help.

PREPARATION

- * Before beginning assembly of product, make sure all parts are present. Compare parts with part contents list and hardware contents list.
- * If any part is missing or damaged, do not attempt to assemble the product.
- * Estimated Assembly Time: 10 minutes.
- * Tools Required for Assembly (included): Allen Key

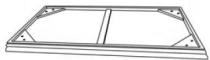
CARE AND MAINTENANCE

Always use felt pads under all articles to prevent discoloration or softening of the lacquer. Plastic and rubber bases on items can discolor wood. Wipe up spills immediately and avoid common hazards such as hot dishes, harsh solvents and abrasives. Cleaning should be done with a soft lint free cotton cloth dampened with water or furniture polish. On highly used surfaces we recommend applying a quality paste wax which should be used on a regular basis to provide additional protection from scratches and spills. How often you apply the wax depends on how much wear the furniture receives.

PIECE	DESCRIPTION	PICTURE	QUANTITY
A	Table top		1x
B	Leg		4x
HW1	Flat washer M6		8x
HW2	Allen Bolt M6x40mm		8x
HW3	Allen Key M5		1x

Product Dimensions:47.25"Wx23.7"Dx19.7"H

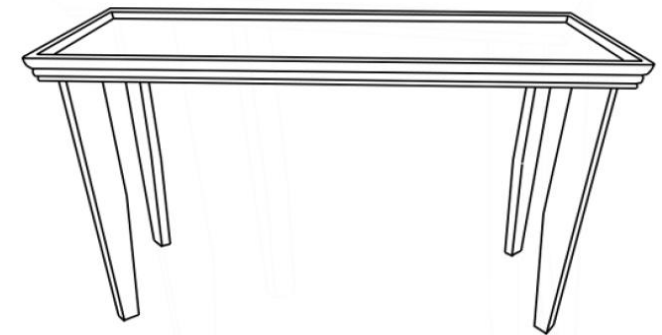

Weight Capacity-70 LBS

Warning:Do not stand on Table

Warning:Do not over torque bolts

PREPARATION

Before beginning assembly of product, make sure all parts are present. Compare parts with package contents list and hardware contents list.

If any part is missing or damaged, do not attempt to assemble the product.

Estimated Assembly Time: 10 minutes.

Tools Required for Assembly (included): Allen Key

If you are having difficulty, our friendly Customer Care team is always here to help.

Step 1

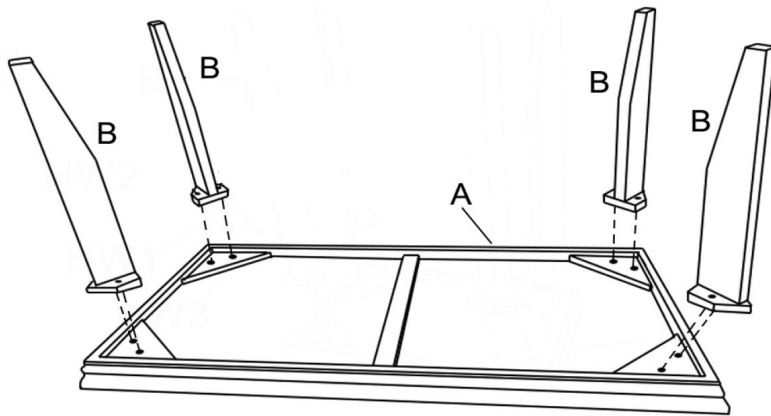

Upside down the table top on ground, attached legs to it

Step 2

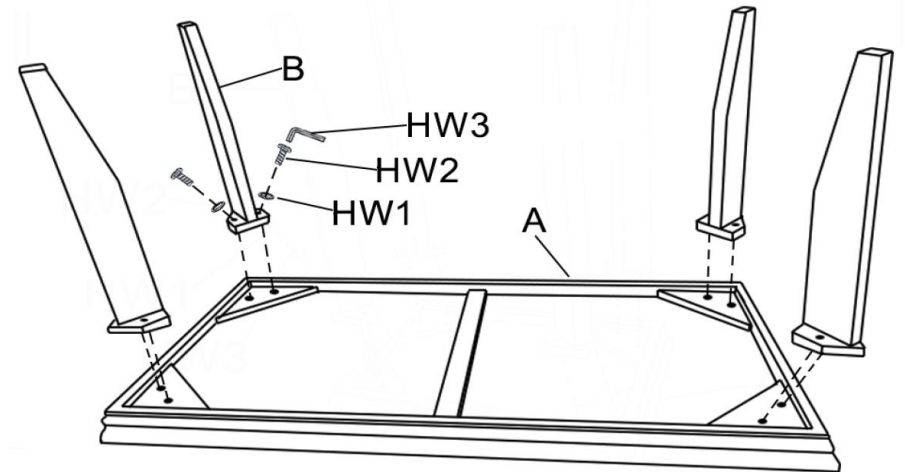

Screw all bolts by Allen Key