

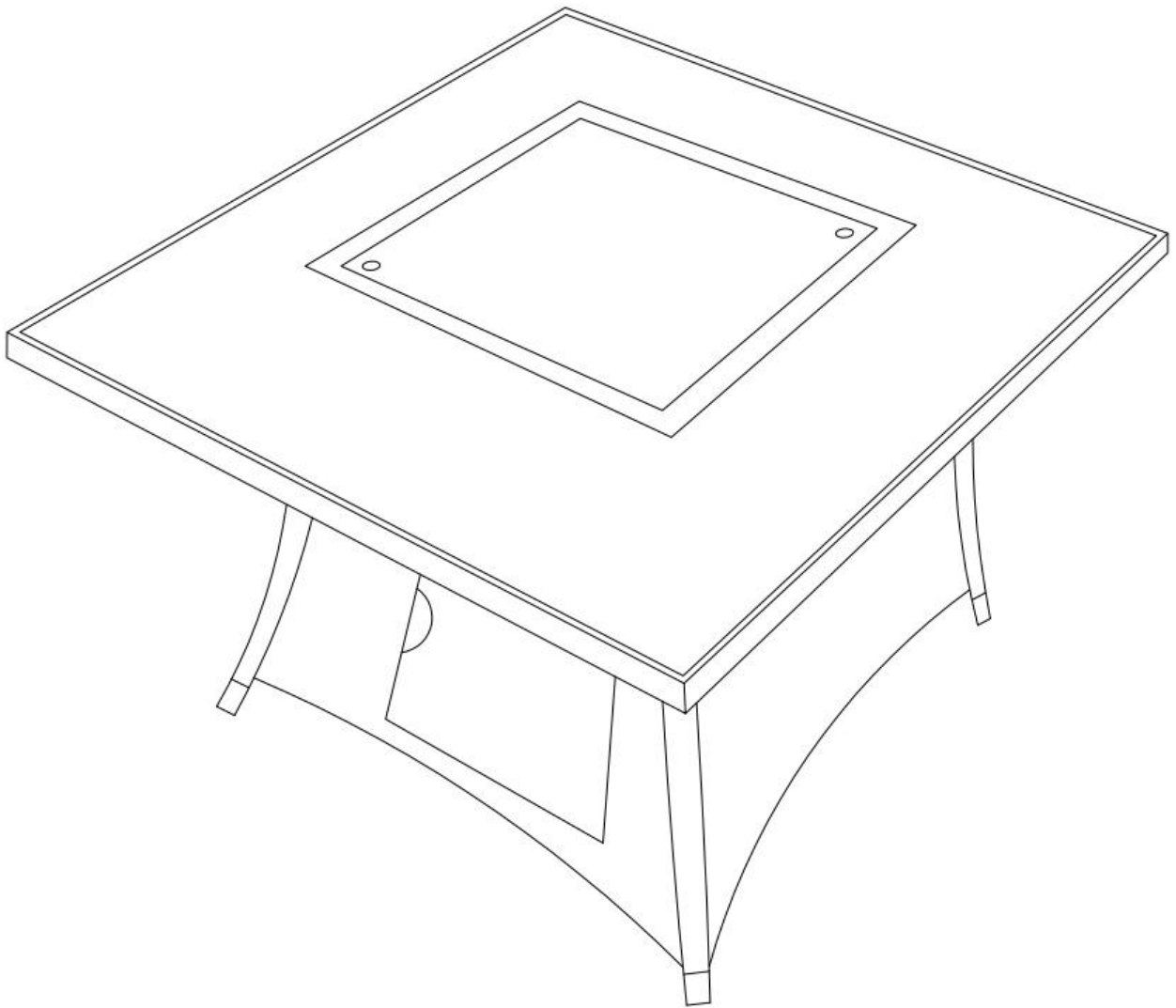

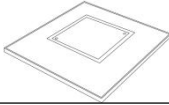

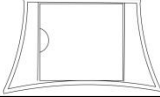







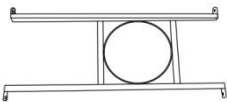

OUTDOOR FIREPIT

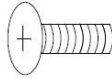
INSTALLATION AND USER'S INSTRUCTIONS

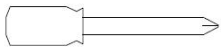

PACKAGE CONTENTS

	PART	DESCRIPTION	QTY
A		FIREPIT TABLETOP	1
B		BOTTOM SUPPORT	1
C		PART A	1
D		PART B	1
E		PART C	1
F		PART D	1
G		SQUARE BRAZIER	1
H		BURNER COVER	1
I		1/4"*18 BOLTS	16
J		M4 BOLTS	4
K		M4 SCREW NUT	4
L		WASHERS	16
M		"AAA" BATTERY (1.5V)	1
N		GLASS	1
O		SCREWDRIVER	1
P		HEX BOLT DRIVER	1

ASSEMBLY

NOTE: It is best to use TWO PEOPLE for assembly of this gas fire pit.

1. Carefully unpack all items from the box. Place the base in the final position. There must be a minimum of 48 in / 122 cm of clearance from the side of the table top to any combustible walls.
2. Place the tabletop on the base. Secure the tabletop to the firepit base using the bolts and washers that are provided

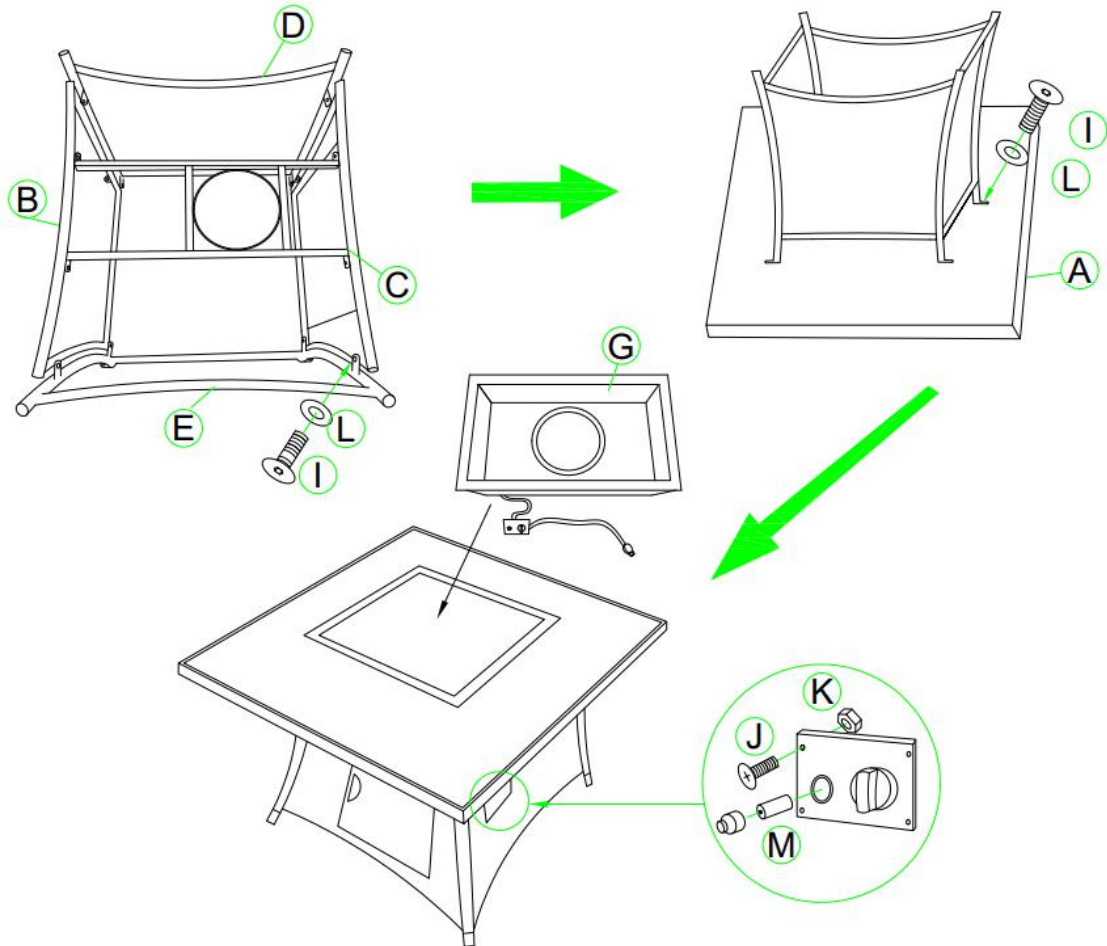

1、F、H 未在图中显示

2、B、C 片标识反

3. Pour the lava rock into the burner pan completely covering the burner.
4. Connect the hose and regulator to the cylinder. The propane gas and cylinder are sold separately. Use a standard 20 lb / 9.1kg. propane cylinder only. Use this fire pit only with a propane vapor withdrawal supply system. See Chapter 5 of the standard for storage and handling of liquefied petroleum gas, ANSI/NFPA 58. Your local library or fire department should have this book. Storage of an appliance indoors is permissible only if the cylinder is disconnected and removed from the appliance. A cylinder must be stored outdoors in a well-ventilated area out of reach of children. A disconnected cylinder must have dust caps tightly installed and must not be stored in a building, garage or any other enclosed area. The maximum inlet gas supply pressure: 250 psi..

The minimum hourly of 50000 Btu is required input rating for a fire pit at rating less than full input rating. The pressure regulator and hose assembly supplied with the appliance must be used.

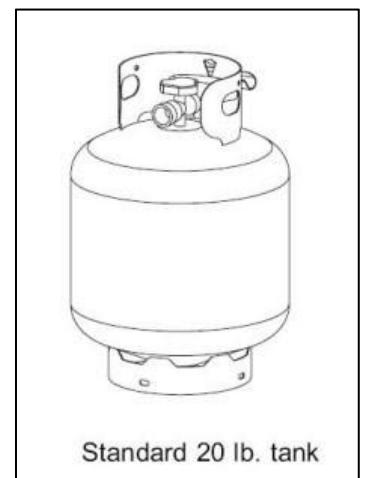

Standard 20 lb. tank

The installation must conform with local codes, or in the absence of local codes, with national fuel gas code, ANSI Z223.1/NFPA54, natural gas and propane Installation Code, CSA B149.1, or propane storage and handling code, B149.2.